

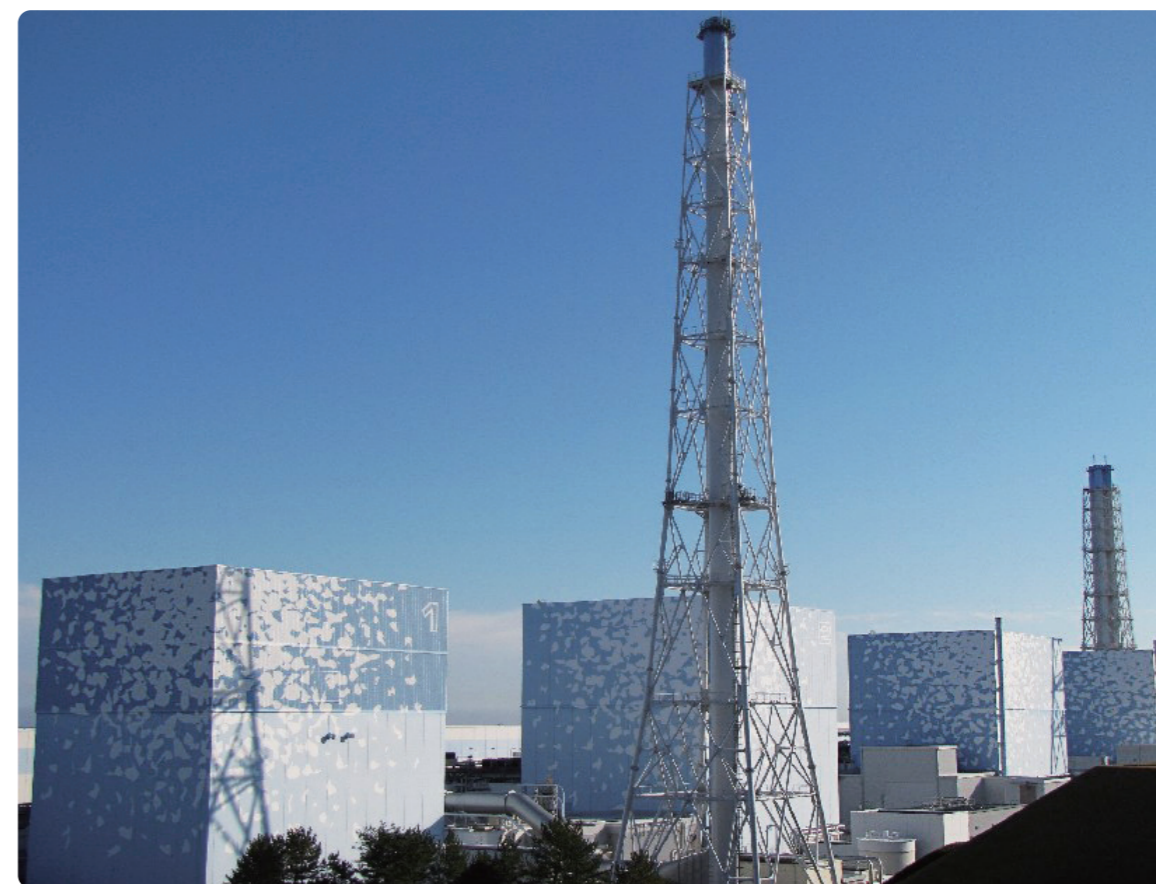

TOKYO ELECTRIC POWER COMPANY

The Development of and Lessons from the Fukushima Daiichi Nuclear Accident



Fukushima Daiichi Nuclear Power Station, prior to the accident
(from left to right, Units 1, 2, 3, and 4; photographed November 2009).

Greetings and Introduction to This Booklet

We wish, first of all, to express our deepest apologies for the trouble and worry that we have imposed on so many people due to the accident at Tokyo Electric Power Company's Fukushima Daiichi Nuclear Power Station. We are moving forward at TEPCO with our investigations and analysis of the development of the Fukushima nuclear accident so that such an accident does not occur again.

In this booklet, we report on the results of those investigations and explain the lessons we have taken away from this accident.

The accounts in this booklet about the Fukushima Daiichi and Daini nuclear power stations have been drawn up based on the material contained in TEPCO's Fukushima nuclear accident investigation report.



Fukushima Daiichi Nuclear Power Station, after the accident
(from left to right, Units 1, 2, 3, and 4; photographed March 16, 2011)

How This Booklet Is Organized

1.

Introduction



Understanding the Fukushima Daiichi Nuclear Accident

Presenting information to help toward understanding the Fukushima Daiichi nuclear accident.

- 1-1. Shutting down, Cooling down, Confining inside P03
- 1-2. Cooling P05
- 1-3. What happens when cooling is performed? P07



2.

Review



Why did Fukushima Daiichi Nuclear Power Station end up experiencing a severe accident?

Explains how the accident developed at each unit of Fukushima Daiichi Nuclear Power Station and contrasts it with Fukushima Daini Nuclear Power Station, which did not experience a severe accident.

- 2-1. Outline of the development of the accident at Fukushima Daiichi Units 1, 2, and 3 P09
- 2-2. Scale of the Earthquake and Tsunami that struck Fukushima Daiichi Nuclear Power Station and Flooding Situation ... P11
- 2-3. Why did Unit 1 experience a severe accident? P13
- 2-4. The development of the accident at Unit 1 P15
- 2-5. Why did Unit 2 experience a severe accident? P17
- 2-6. The development of the accident at Unit 2 P19
- 2-7. Why did Unit 3 experience a severe accident? P21
- 2-8. The development of the accident at Unit 3 P23
- 2-9. Why was there a hydrogen explosion at Unit 4? P25
- 2-10. The development of the accident at Unit 4 P27
- 2-11. The magnification of damage due to simultaneous accidents at Units 1 to 4 P29
- 2-12. Why did Fukushima Daini Nuclear Power Station escape a severe accident? P31
- 2-13. Comparison of units with core damage and units in cold shutdown P33



3.

Plans



Lessons Learned from Examination

Explaining the policy on future safety measures for nuclear power stations based on the lessons learned through the accident examination process.

- 3-1. Lessons obtained from the accident and future responses P35

Initiatives aimed at maintaining safety at Fukushima Daiichi Nuclear Power Station / TEPCO's efforts toward maintaining safety in the future / Regarding the release of information ... P37

Shutting down, Cooling down, Confining inside

(in the case of Fukushima Daiichi Nuclear Power Station Unit 1)

What is the philosophy behind how nuclear power stations are designed to maintain safety? We begin by first explaining about "Shutting down, Cooling down, Confining inside", which underlies that philosophy.

Nuclear reactors are designed to maintain safety based on a philosophy of "Shutting down, Cooling down, Confining inside."

0. Protect

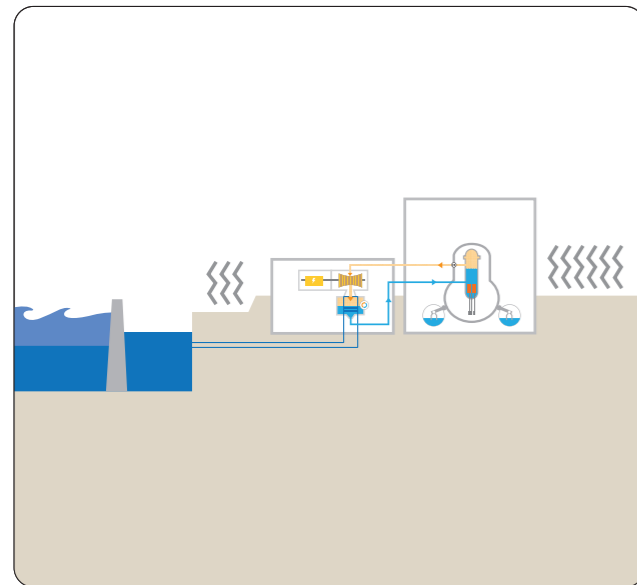

Design mindful of the height of tsunami and strength of earthquakes

Elements on the site of a power station are designed with provisions for the onslaught of conceivable earthquakes and tsunami.

1. Shutting down

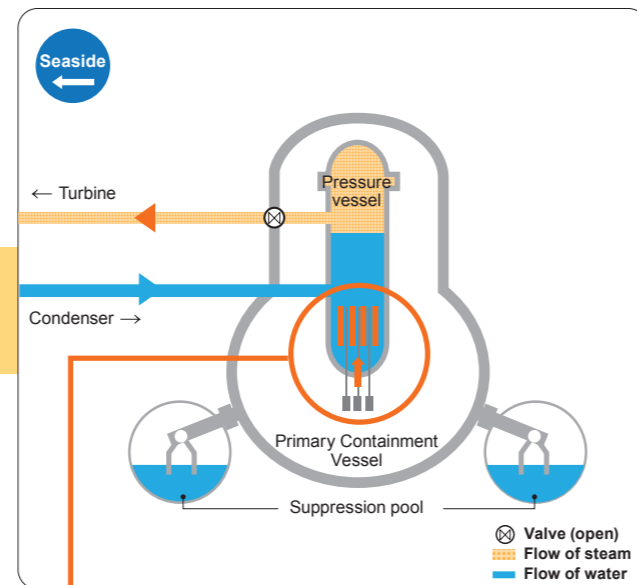

Emergency shutting down through insertion of control rods

Control rods are swiftly inserted in emergencies such as major earthquakes and the reactor undergoes an emergency shutting down.

2. Cooling down

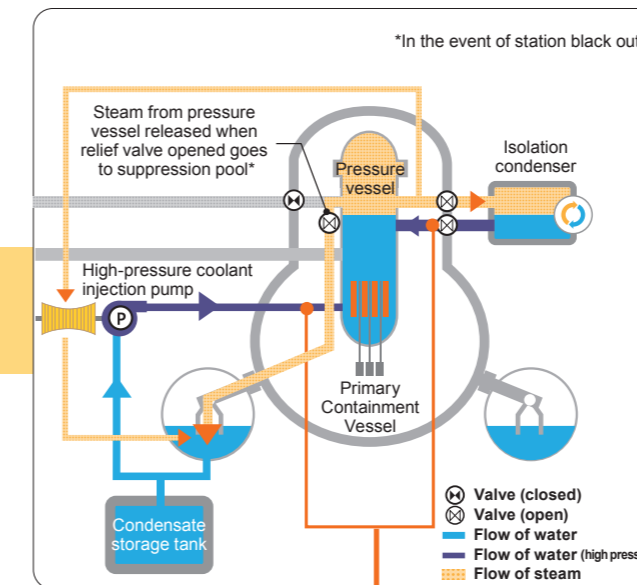

Cooling of the pressure vessel through injection and circulation of water

Equipment for sending a large amounts of water into the reactor is installed so that the fuel does not rise to high temperatures and the reactor core is not heating while empty.

3. Confining inside

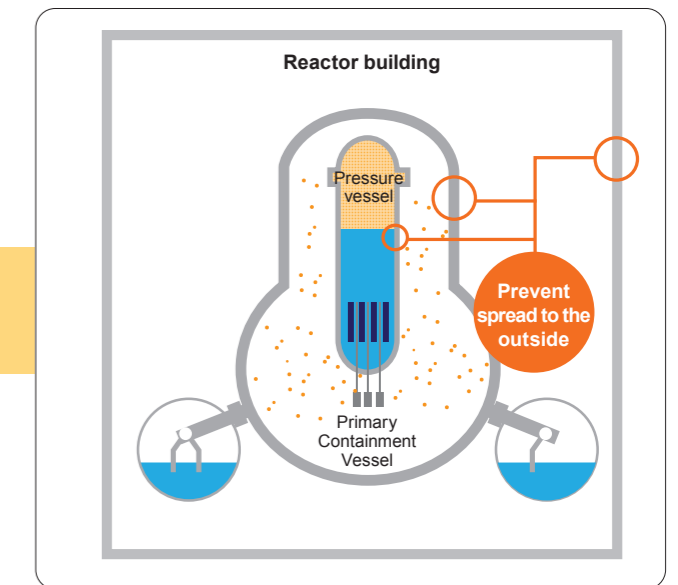

Radioactive materials are confined inside with pressure vessels, primary containment vessels, and the like

Protective walls are installed to confine inside radioactive materials so that they do not get outside even in an accident.

Names of each part of a nuclear power plant and the flow of heat in normal conditions (example of boiling water reactor)

[Flow of heat generated from reactor]

- ① Steam produced by the reactor's heat is sent to the turbines
- ② Turbines are turned by that steam, generating electricity
- ③ Steam that turned the turbines is cooled by the condenser and returned to water (Normal seawater is used for cooling)

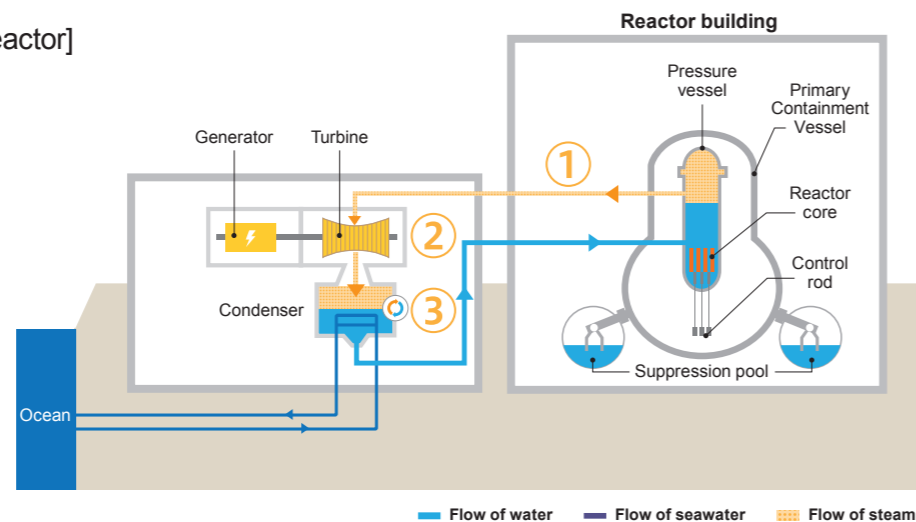

If cooling fails...

Water level in the pressure vessel falls, leading to core damage.

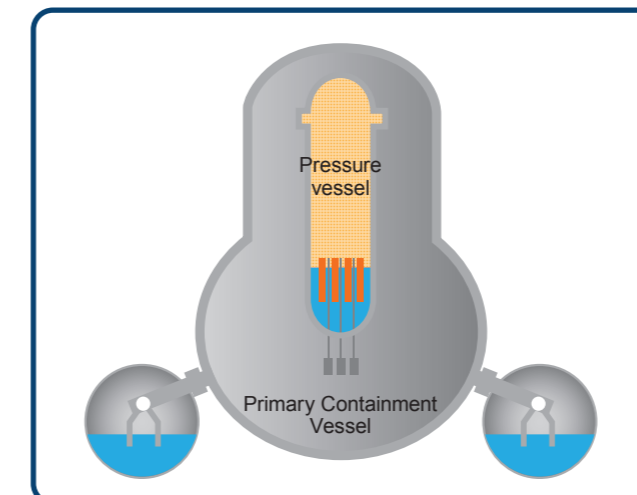

If cooling cannot be performed, it becomes difficult to continue keeping material confined inside. When confining inside fails, it leads to the release of hydrogen and radioactive materials to the outside.

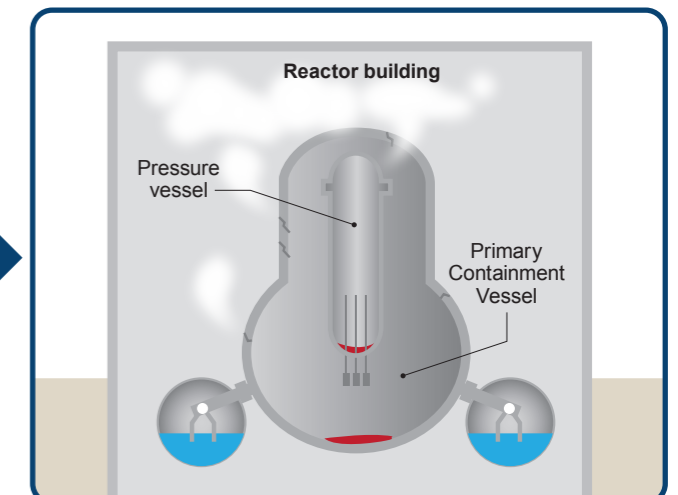

Cooling

(in the case of Fukushima Daiichi Nuclear Power Station Units 2 and 3)

The cause of the accident at Fukushima Daiichi Nuclear Power Station was the failure to "Cooling Down". Here, we explain the "cooling" mechanism of a nuclear power station.

What does it mean to "cool" a nuclear reactor?

The objective of "cooling" a reactor is to achieve a state wherein the reactor is stabilized at "cold shutdown" (a condition in which the temperature of the water within the reactor is below 100°C). To do this requires the removal of what is known as the "decay heat" that the fuel in the reactor continues to produce. The operations that this in turn requires are coolant injection, depressurization, and heat removal. Toward these ends, nuclear power stations are fitted with the equipment shown below.

The difference between "injecting coolant" and "removing heat"

Both "injecting coolant" and "removing heat" are methods for "cooling down." "Injecting coolant" is a method for getting cold water into a pressure vessel to cool the reactor core, while "removing heat" is method for transferring the heat of the reactor to water to release it outside. In an emergency, coolant—which is quite readily available—is injected. However, since the heat from the reactor core can end up being retained within the primary containment vessel when just injecting coolant, it is necessary to eventually perform "heat removal."

High-pressure coolant injection

Water is put into the high-pressure reactor pressure vessel to cool the reactor core and maintain water levels.

Equipment name	High-pressure coolant injection system (HPCI) Reactor core isolation cooling system (RCIC)
Driving source	Reactor steam
Power source	DC power (for control use)

Depressurization

Lower the pressure of the pressure vessel to enable low-pressure coolant injection and heat removal.

Equipment name	Safety relief valve
Driving source	Nitrogen gas under high pressure
Power source	DC power (for control use)

Low-pressure coolant injection

Introduce water to cool the reactor core and maintain water levels

Equipment name	Core spray system Make-up water condensate system Fire protection system
Driving source	AC power Diesel engine
Power source	AC and DC power (for control use) DC power (for control use*) <small>*Dedicated battery</small>

Heat removal

Transfer the heat coming from the reactor core to water to release it outside

Equipment name	Residual heat removal system Primary containment vessel vent
Driving source	AC power Compressed air (for vent operations)
Power source	AC and DC power (for control use) AC power (for control use)

Shutting down (emergency trip by insertion of control rods)

When it is possible to use emergency power sources (AC, DC)

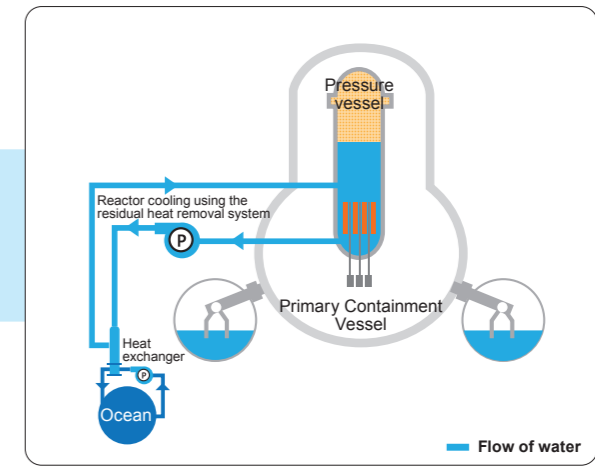
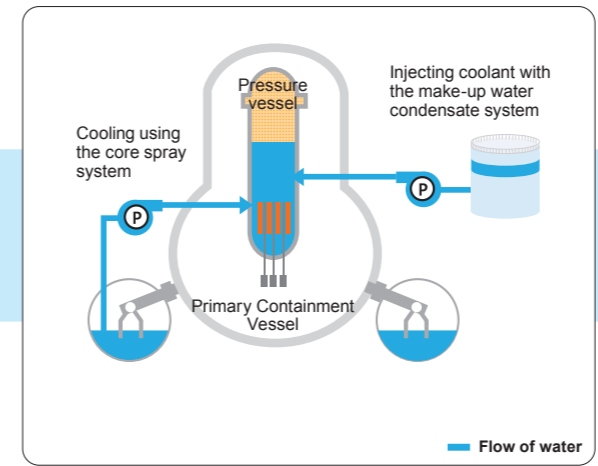
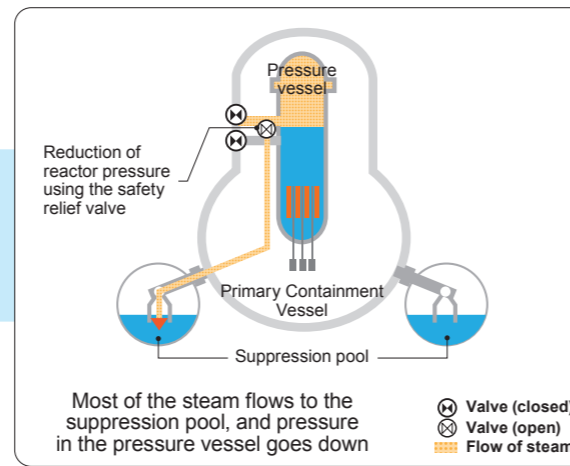
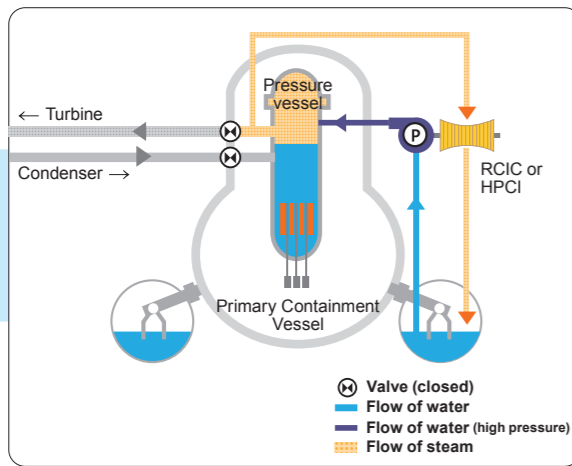

In the event of station blackout

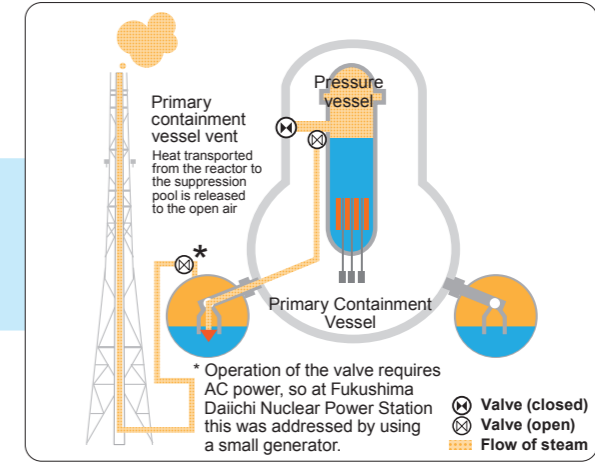
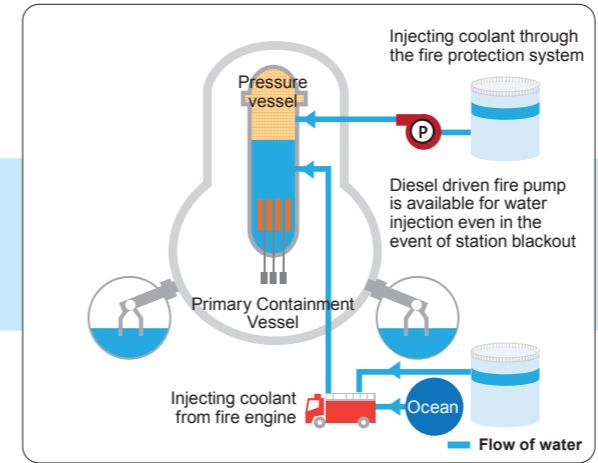
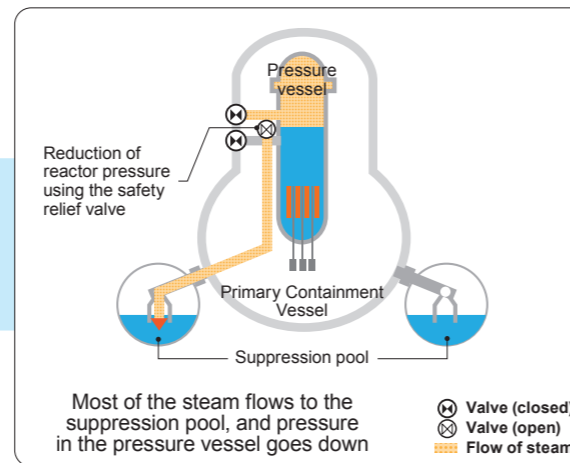
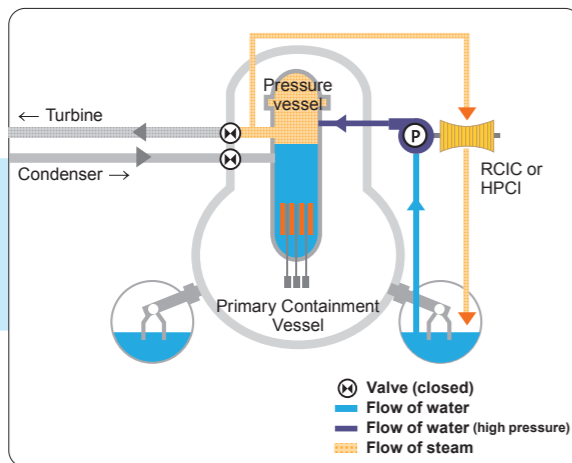

What happens when cooling is performed?

(in the case of Fukushima Daini Nuclear Power Station Unit 2)

What happens inside the reactor and primary containment vessels when "cooling down" functions operate? We will explain this in connection with the parameter changes at Fukushima Daini Nuclear Power Station Unit 2, where it is relatively easy to see how the changes unfolded.

Change the internal reactor parameters through "cooling" functions (as illustrated by Fukushima Daini Reactor 2)

"Cooling down" process

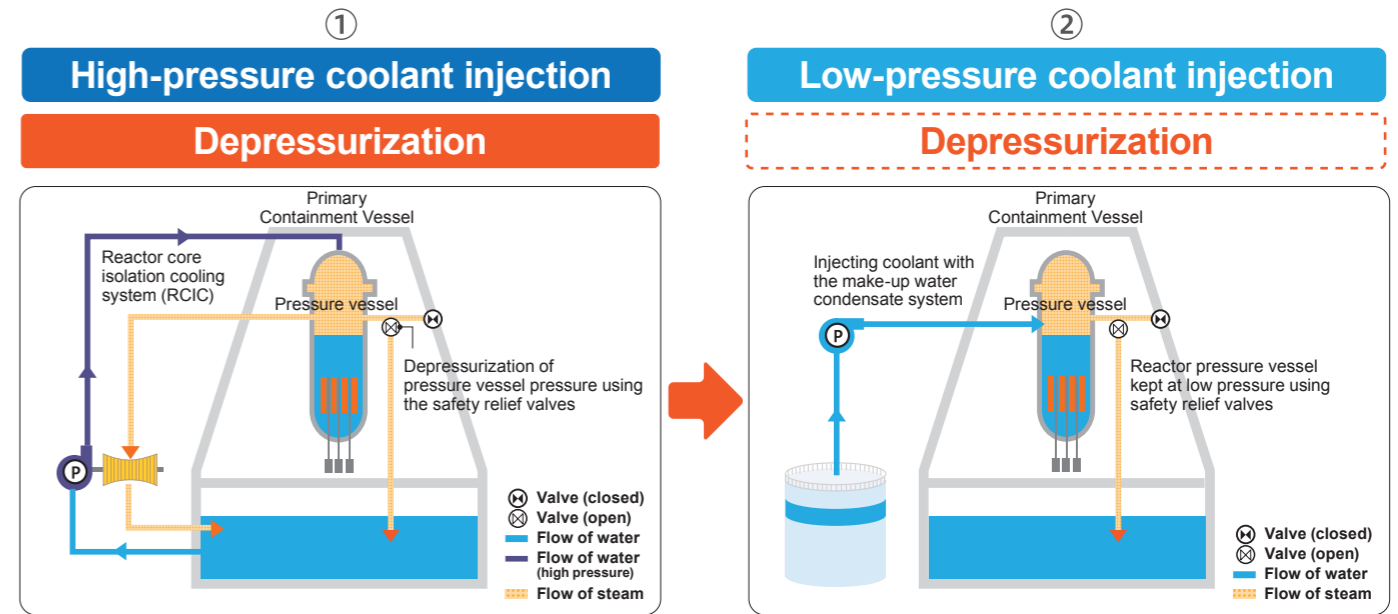
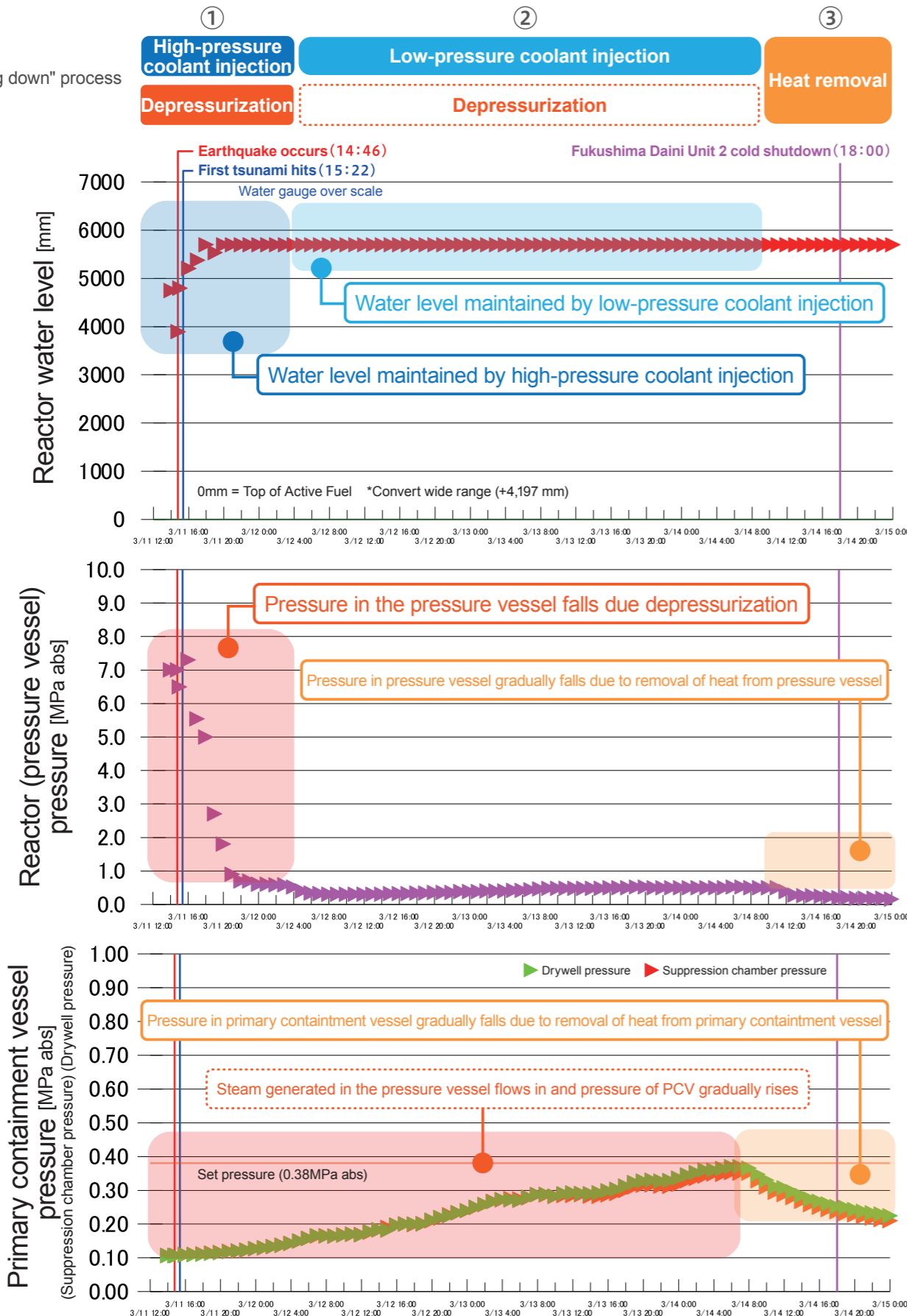

Water level is maintained by the HPCI system (or RCIC system), and pressure in the pressure vessel is lowered using the safety relief valve.

Water level is maintained through low-pressure coolant injection (make-up water condensate system), and pressure in the primary containment vessel is raised by transferring steam from the pressure vessel to the primary containment vessel.

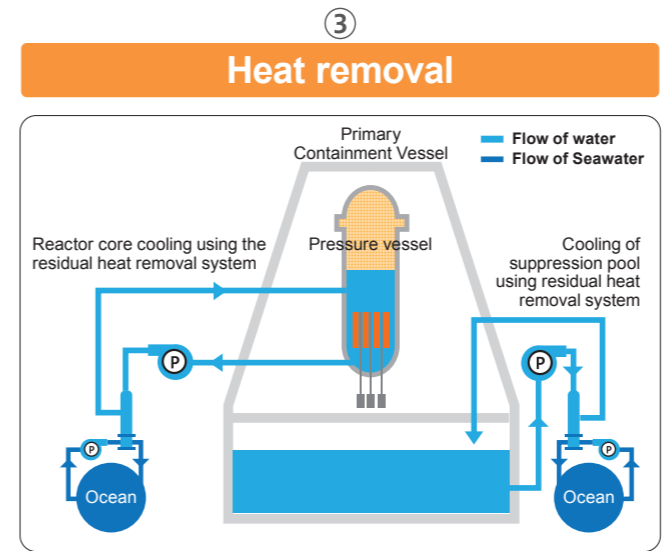

By starting heat removal, the flow of steam from the pressure vessel is halted while the primary containment vessel cools and its pressure gradually falls.

Differences in primary containment vessel shape
The shapes of the primary containment vessels at Fukushima Daiichi Units 1-5 (left) differ from those at Fukushima Daiichi Unit 6 and Fukushima Daini Units 1-4 (right), but they all play the same role.

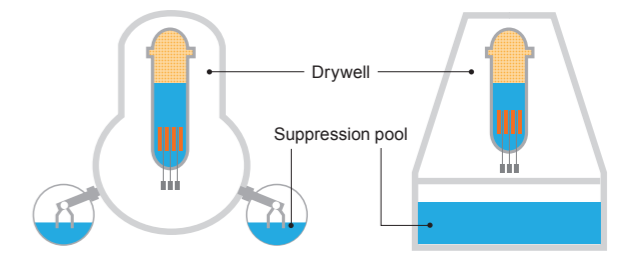

How much heat is generated?

- Volume of water circulating during normal operation:**
 - Generator, Turbine, Steam, Feed-water pump, Water, Ocean, Condenser.
 - Volume of water circulated approx. 6,400 t/h. About 16x amount of retained water normally circulates.
 - Retained water in the pressure vessel: approx. 400 tons.
- Decay heat progress after emergency reactor shutting down:**
 - Thermal output vs. Elapsed time (hours) curve.
 - During rated operation (approx. 3,300MW).
 - Reduce calorie volume by 7% simultaneously at the time of shut down.
 - Even 5 hours after emergency trip, residual heat have generated equivalent to 1% of nominal thermal power.
 - Energy to vaporize 1 ton of water in a few minutes.
 - Heat continues to be generated in large amounts even after reactor shutting down, so it is necessary to continue cooling with large volumes of water.

*Figures are based on Fukushima Daini Unit 2

Why did Fukushima Daiichi Nuclear Power Station end up experiencing a severe accident?

Outline of the development of the accident at Fukushima Daiichi Units 1, 2, and 3

Units 1, 2, and 3 at Fukushima Daiichi Nuclear Power Station ended up experiencing severe accidents. These accidents had their origin in a loss of "cooling down" function. The general development of what happened thereafter was the same for Units 1, 2, and 3. The biggest reason for the loss of "cooling down" functions was the loss of the power sources used to operate and control those functions.

Outline of the development of the accident at Fukushima Daiichi Units 1, 2, and 3

Fukushima Daiichi Nuclear Power Station Units 1, 2, and 3—which had been operating at the time—experienced severe accidents in which there was a failure to keep the reactor cores cool after they had been shut down, resulting in damage to the cores.

The accident developed in the same way at each Unit: injecting coolant into the pressure vessels became impossible after reactor shutdown, the water in the pressure vessels ran out, fuel temperature rose, hydrogen was generated in large quantities, the fuel melted, the pressure vessels were damaged, the primary containment vessels were damaged, and eventually both hydrogen and radioactive materials were released into the reactor buildings. The greatest underlying cause of the inability to perform cooling was that it became no longer possible to operate and control the "cooling down" systems due to a loss of power. The timing at which power and "cooling down" function were lost differed from unit to unit, but the general outline of how the accident developed was the same at Units 1, 2, and 3.

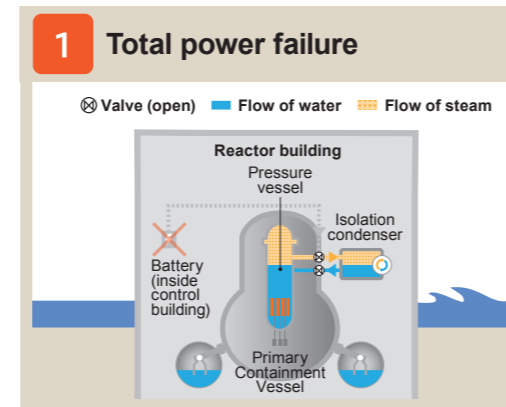

1 Total power failure
Transmission of offsite (AC) power failed primarily due to the earthquake, while the emergency diesel generators (AC) and batteries (DC) failed due to flooding from the tsunami.

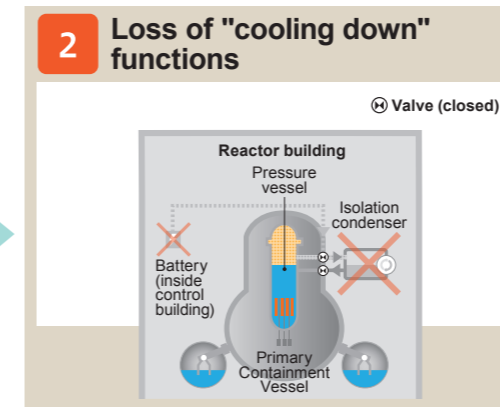

2 Loss of "cooling down" functions
None of the cooling functions could be used due to the losses of power.

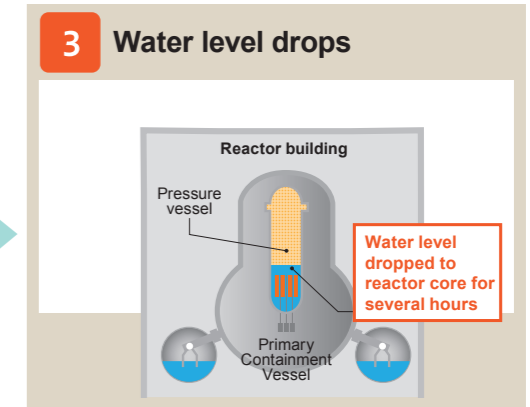

3 Water level drops
Due to decay heat, the water in the pressure vessel turned to steam and the water level dropped.

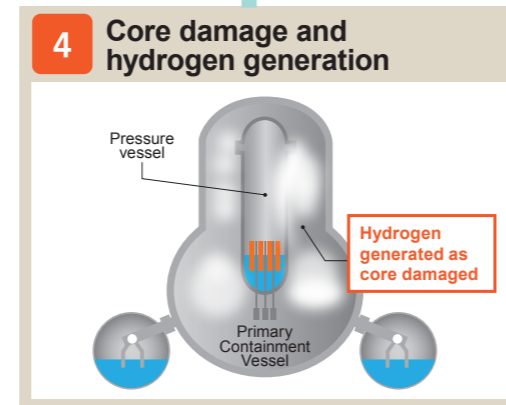

4 Core damage and hydrogen generation
With the drop in water level, the fuel became exposed and its temperature rose. The high temperature fuel reacted with water vapor to generate hydrogen, and the fuel itself became damaged due to the high temperature.

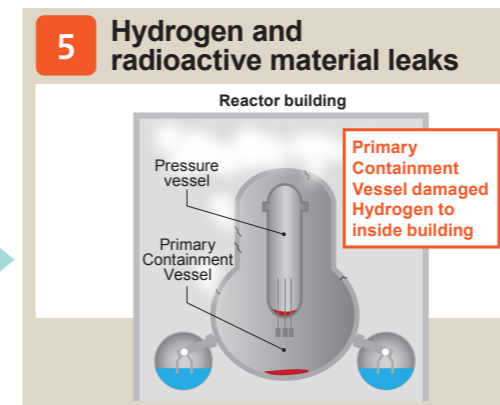

5 Hydrogen and radioactive material leaks
The pressure and primary containment vessels were damaged, and hydrogen and radioactive materials leaked inside the reactor building. (Hydrogen explosions occurred at Units 1 and 3, where hydrogen had built up inside the reactor buildings.)



Fukushima Daiichi Nuclear Power Station, after the accident (from left to right, Units 1, 2, 3, and 4; photographed March 16, 2011)

We will explain in detail about developments at each unit from page 13.

Summary of developments at each unit

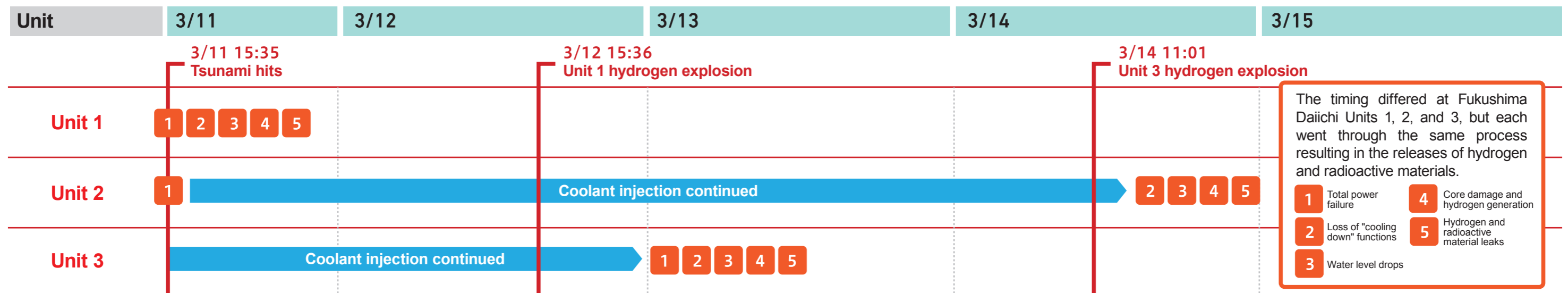

Scale of the Earthquake and Tsunami that struck Fukushima Daiichi Nuclear Power Station and Flooding Situation

A tremendous tsunami struck the nuclear power station that had been brought to an emergency trip by the earthquake. Flood waters reached buildings, and power supply equipment and other important facilities could no longer be used.

Maintain functionality of key safety facilities following an earthquake

No damage from the earthquake to key safety facilities has been confirmed.

A magnitude 9.0 earthquake occurred at 2:46 p.m. on March 11, 2011 (Friday), with an epicenter on the ocean floor off the coast of Sanriku. The Fukushima Daiichi Nuclear Power Station was among those hit by strong shaking. However, Units 1, 2, and 3—operating at the time of the earthquake—all made emergency trips. Additionally, their emergency diesel generators started up and cooling of their reactor cores began.

The earthquake caused damage to some routine equipment, such as power transmission and receiving facilities, but no damage to key safety facilities, such as emergency diesel generators and coolant injection and heat removal equipment, has been confirmed.

Occurred at 2:46 p.m. on March 11, 2011
Magnitude 9.0

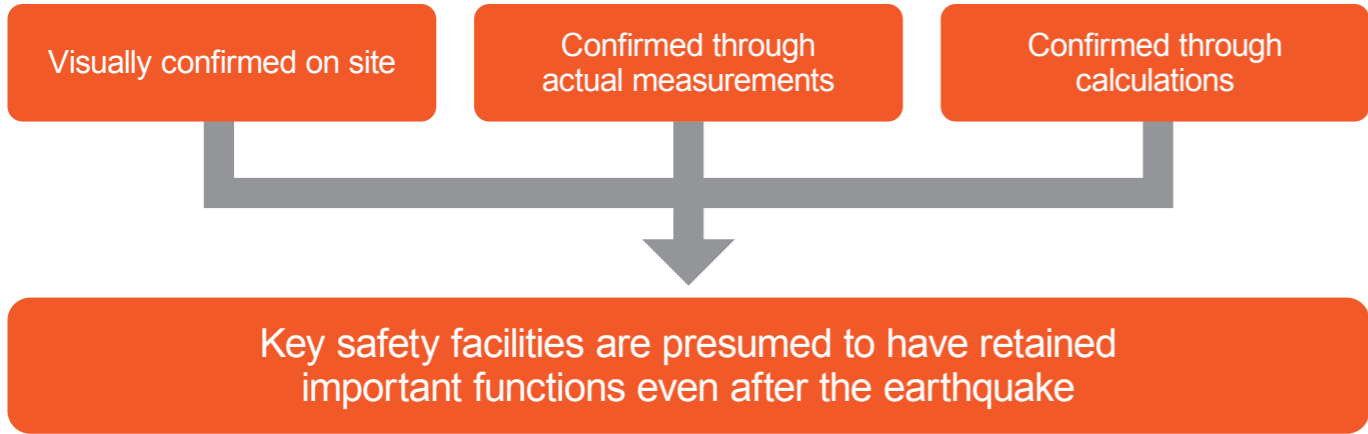

Almost all power, as well as coolant injection and heat removal function, was lost due to the tsunami

There was damage at Fukushima Daiichi Nuclear Power Station, including damage to outdoor equipment and flooding of important facilities.

Fukushima Daiichi Nuclear Power Station took a direct hit from an enormous tsunami about 50 minutes after the earthquake happened. Pumps and other outdoor equipment installed on the seaside for releasing heat from the reactor to the sea were damaged, and almost the entire site on which the reactors were built was flooded as a result of the tsunami. Also, water flooded into the turbine building and other structures and power-supply facilities became unusable. As a result, various key safety functions, such as the injection of coolant into reactors and the ability to monitor status, were lost. Furthermore, a variety of damage was inflicted, such as the spread of debris by the tsunami that prevented people from moving around the site.

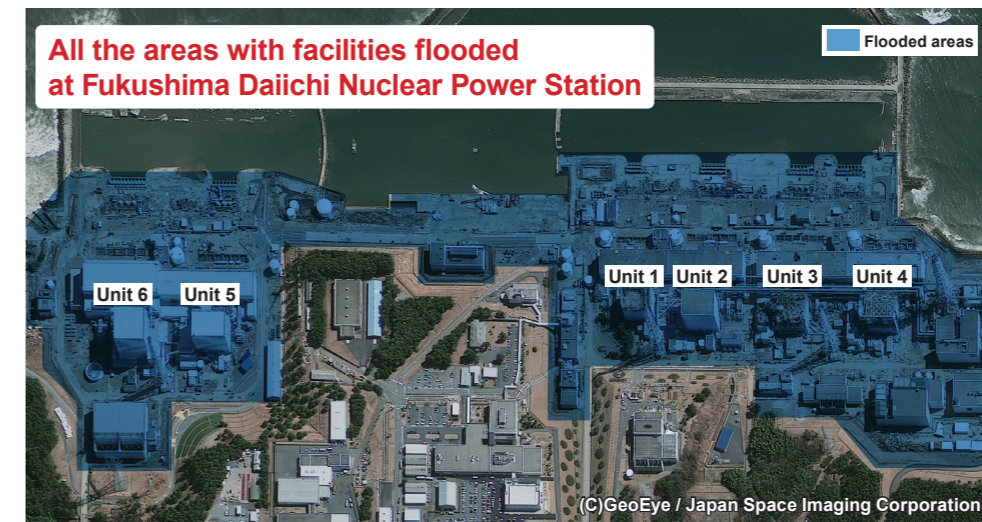

Fukushima Daiichi Nuclear Power Station after having been damaged by the tsunami (overall view); photo taken March 19, 2011



Flooded power room (Fukushima Daiichi Nuclear Power Station Unit 2)

Height of Fukushima Daiichi Nuclear Power Station grounds and tsunami (illustration)

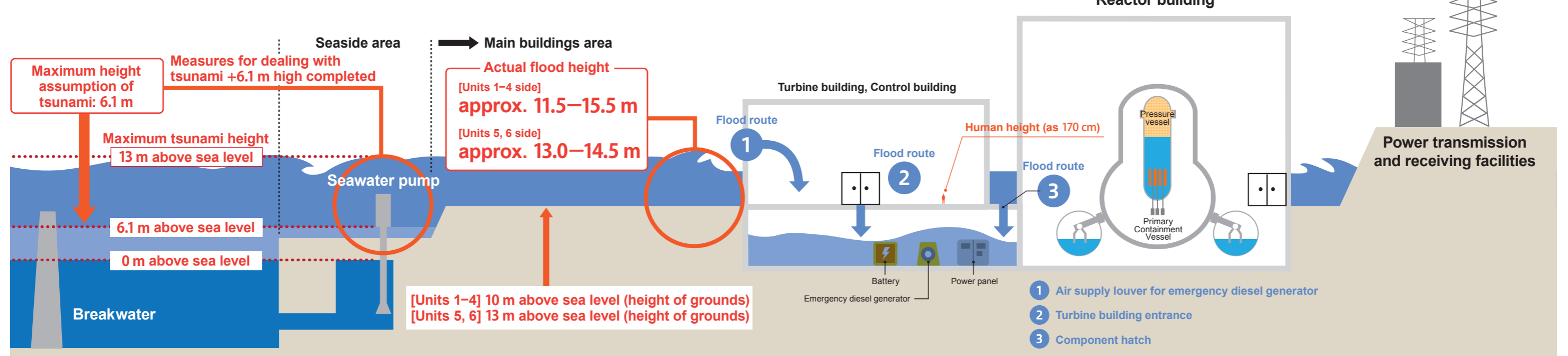

Why did Fukushima Daiichi Nuclear Power Station end up experiencing a severe accident?

Why did Unit 1 experience a severe accident?

The accident at Unit 1

When the earthquake occurred, the control rods were immediately inserted at Unit 1 and, as designed, the reactor automatically tripped. The situation at Unit 1 was such that it had lost all offsite power due to the earthquake and condensers and other equipment had become unusable. However, the emergency diesel generators automatically started and cooling of the reactor by the isolation condenser^{*1} had begun.

But the tsunami that struck about 50 minutes after the earthquake and the flood waters that came with it caused the loss of the emergency diesel generators, batteries (DC power sources), and all sources for the power panels^{*2} and so forth. With the loss of all power sources, the isolation condensers tripped functioning, and the HPCI systems could not be activated. Additionally, owing to the loss of monitoring and measurement function, it became impossible to confirm the status of the reactor and other equipment. After this, the water in the pressure vessel continued to evaporate. About four hours later, the fuel was exposed above the water's surface and core damage began.

Because the surface temperature of the exposed fuel rods rose due to decay heat, the surface of the fuel rods reacted with the water vapor in the pressure vessel and large amounts of hydrogen were generated. The hydrogen that leaked from the damaged parts (thought to be leaked from the top flanges of reactor pressure vessel head and such produced by the temperature rise) of the primary containment vessel gathered in the upper parts of the reactor building. It ignited for some reason and at 3:36 p.m. on March 12—about 24 hours after the tsunami struck—exploded. Also, the melted reactor core penetrated the bottom of the pressure vessel and eroded the concrete on the surface of the primary containment vessel.

The scattering of debris in the surrounding area due to the hydrogen explosion was a major impediment to work, and was also a reason why responses to Units 2 and 3 were delayed.

*1 Isolation condenser: a device that cools the reactor core by cooling the steam in the pressure vessel to return it to water and then sends it back into the pressure vessel.

*2 Power panel: equipment for receiving and distributing electricity. Electricity cannot be sent to any of the equipment within a building if the power panels cannot be used, even if generators and batteries are available.

Conditions in a flooded power room



Unit 1 reactor building immediately after the hydrogen explosion



Damage to an isolation condenser



Offsite power was lost due to the earthquake at Unit 1, but the emergency diesel generator started and function was preserved with respect to maintaining safety. However, owing to the tsunami, all power, both AC and DC, was lost and the Unit's "cooling down" function became unusable. Due to this, the water level in the reactor continued to drop, the reactor core was damaged, and the hydrogen generated as a result leaked inside the reactor building, leading to a hydrogen explosion.

Changes at Unit 1 when the earthquake happened and the tsunami struck

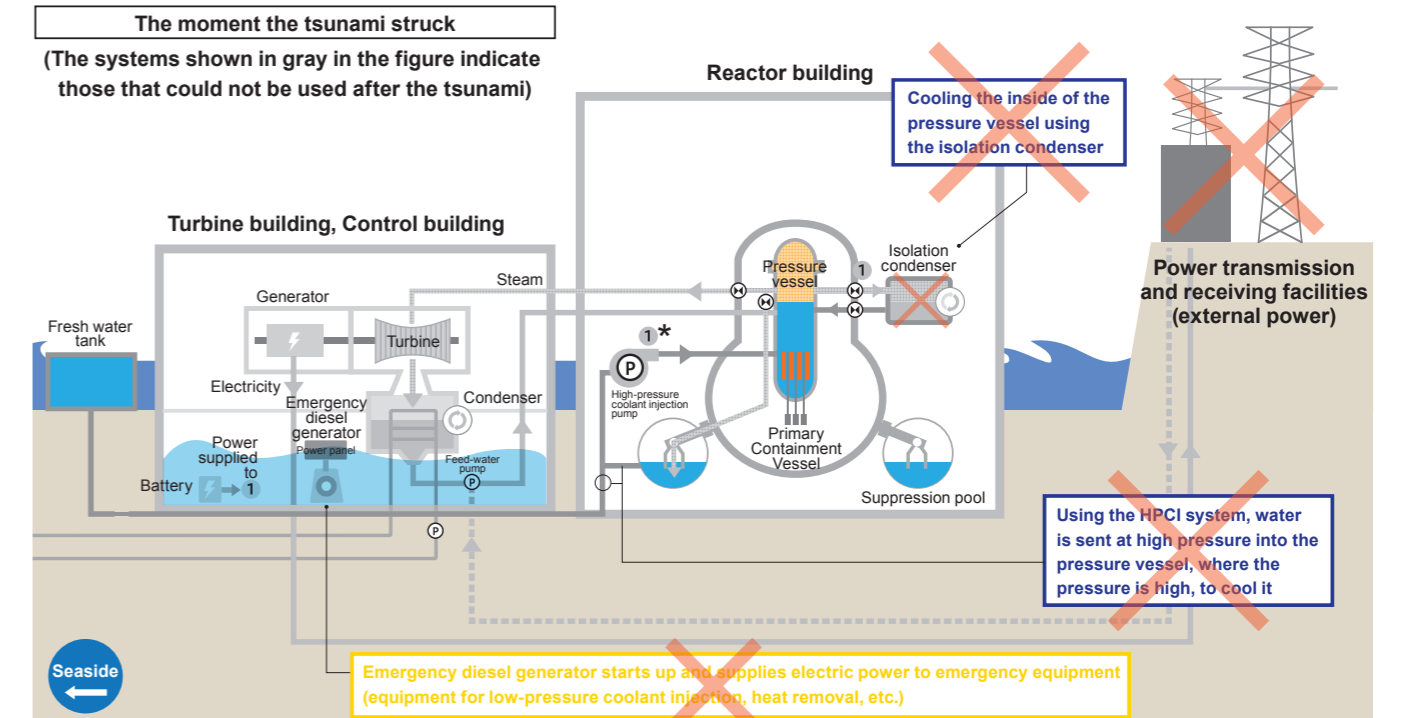
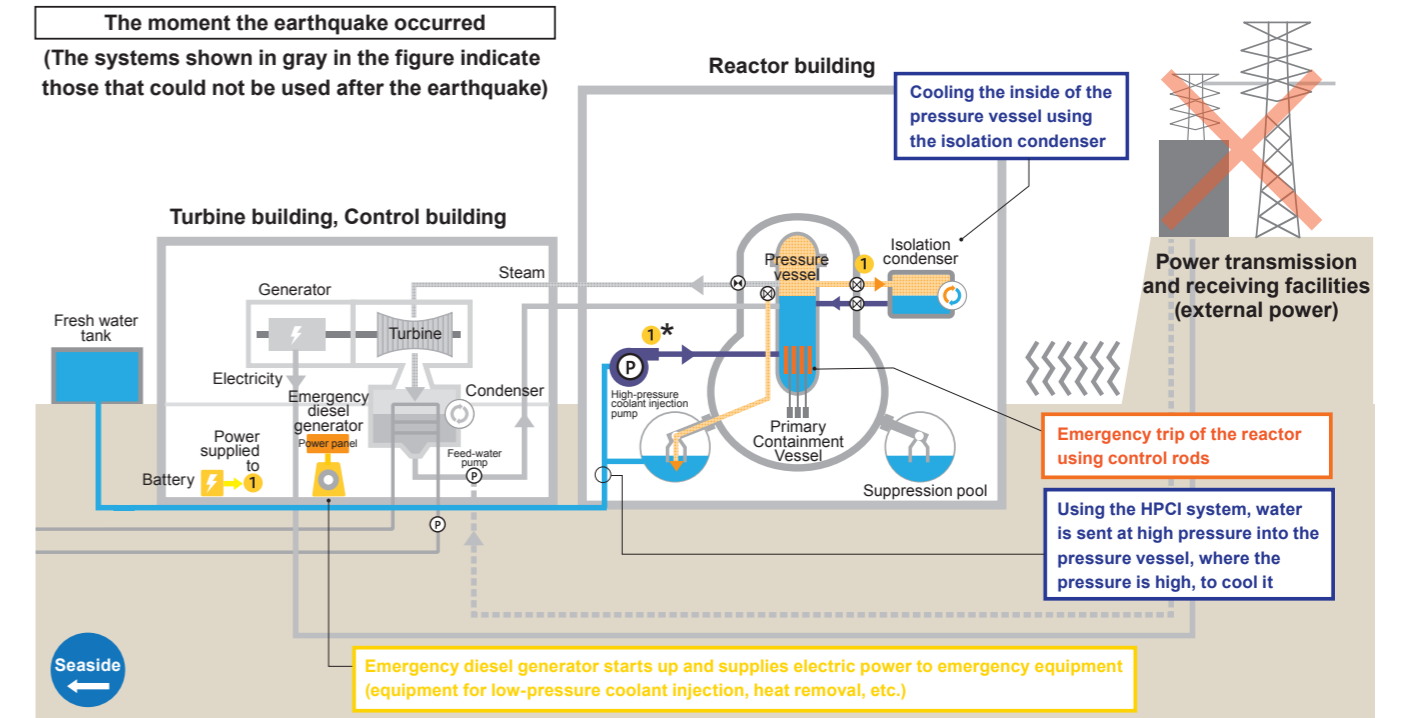

Accident issues of note (Unit 1)

Lessons from the accident	Problem(s) that arose
1: Protection from tsunami	<ul style="list-style-type: none"> The buildings and areas outside were flooded due to the tsunami.
2: Guaranteeing power sources/means of injecting coolant	<ul style="list-style-type: none"> All coolant injection and heat removal function was lost due to the loss of all AC and DC power. Owing to the inability to inject coolant or remove heat, the water level inside the pressure vessel dropped and, approximately 4 hours after the tsunami, the core was damaged.
3: Impact mitigation after core damage	<ul style="list-style-type: none"> The hydrogen generated due to the core damage leaked from the pressure and primary containment vessels to the inside of the reactor building and a hydrogen explosion occurred. The melted reactor core penetrated the pressure vessel and eroded the concrete of the primary containment vessel.
4: Assessing the situation at the plant	<ul style="list-style-type: none"> Due to all power having been lost, the means for illumination, communication, monitoring, and measuring were lost. In addition, all units had simultaneously fallen into a crisis situation. This all produced confusion in the initial response and inadequacies in the sharing of information.
5: Improvements to the recovery work environment	<ul style="list-style-type: none"> Due to concerns about major aftershocks and attendant tsunami as well as the scattering of debris, accessibility to the site and the capacity to do work there were reduced.

Why did Fukushima Daiichi Nuclear Power Station end up experiencing a severe accident? The development of the accident at Unit 1

The development of the accident at Unit 1

The nuclear reactor underwent an emergency trip after the earthquake. Offsite power had been lost, but the emergency diesel generator started automatically. The isolation condenser was used and cooling of the reactor core proceeded. However, with the loss of all electrical power due to the tsunami, the cooling functions provided by the isolation condenser and the HPCI system were lost. With the means for cooling having been lost, the water level inside the pressure vessel dropped. Core damage proceeded, the hydrogen that was generated leaked into the reactor building, and a hydrogen explosion occurred.

14:46 Earthquake occurred

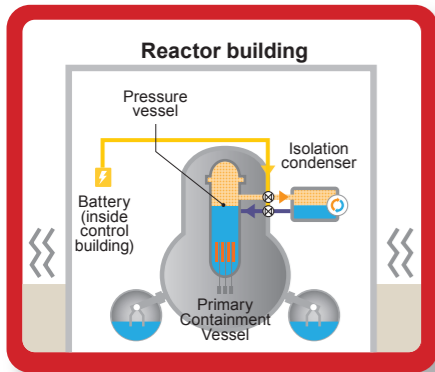

15:35 Tsunami hits

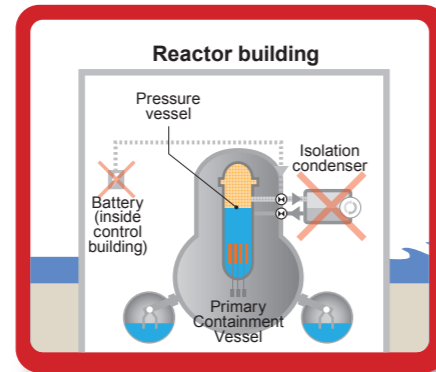

Isolation condenser became unusable due to the tsunami

The isolation condenser can perform cooling just by opening and closing a valve. The valve on the isolation condenser was opened and closed to slowly cool the reactor core after the earthquake. However, this valve was closed when all power was lost due to the tsunami. It could not be reopened for that reason, and the isolation condenser lost its cooling function.

With the loss of power due to the tsunami, cooling of the reactor core became problematic

Hydrogen leaks into building

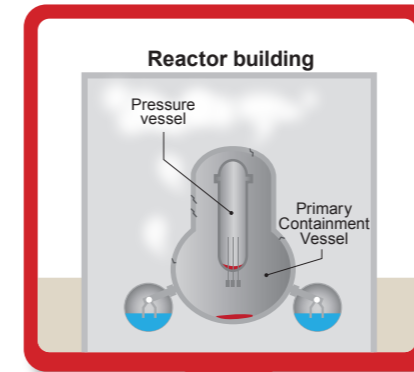

15:36 Hydrogen explosion in the Unit 1 reactor building



3/11

Cold shutdown process in normal conditions

Cold shutdown process in an emergency

Responses and events after the tsunami occurred

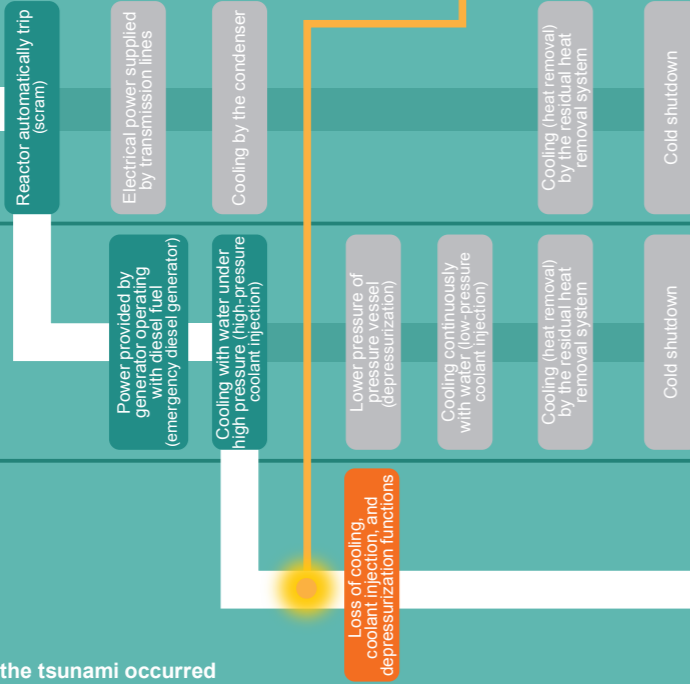

Water vapor reacted chemically with zirconium on the exterior of the fuel rods and hydrogen was generated in a large massive amounts

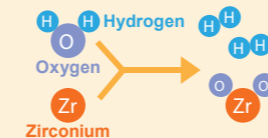

3/12

Around 4:00 a.m.

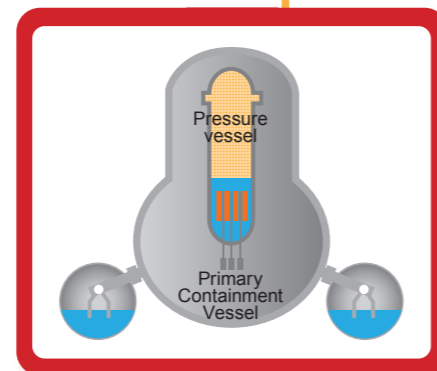

Water level inside the pressure vessel dropped

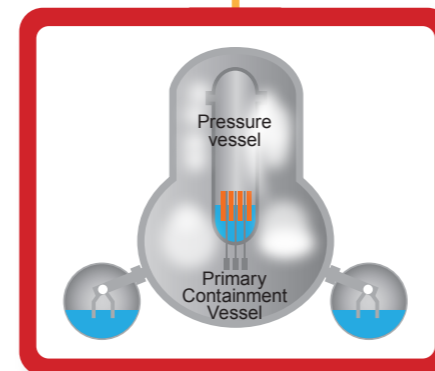

Hydrogen generation occurred

It is possible that the sequence with respect to the drop in water level, core damage, and hydrogen generation occurred in a different order due to uncertainties over the amount of coolant injected.

Why did Fukushima Daiichi Nuclear Power Station end up experiencing a severe accident?

Why did Unit 2 experience a severe accident?

The accident at Unit 2

When the earthquake occurred, the control rods were immediately inserted at Unit 2 and, as designed, the reactor automatically tripped. The situation at Unit 2 was such that it had lost all offsite power due to the earthquake and condensers and other equipment had become unusable. However, the emergency diesel generator started automatically and the reactor core isolation cooling system (RCIC) was also able to operate. After this, the emergency diesel generators, batteries, power panels, and all sources of power were lost due to the tsunami and the flood waters that came with it, with the result that the monitoring, measuring, and operational functions of meters and gauges could not be used, along with light sources.

The situation followed almost the same course as at Unit 1 up to this point. However, in the case of Unit 2 the RCIC had been operating prior to the tsunami striking. Even after all power was lost it continued to operate, and so it was able to continue coolant injection for about three days. During that period, a power-supply car was connected to the power panels that escaped being submerged and should have been able to perform coolant injection with other cooling systems. Work to maintain power was moving forward, but because of cables being damaged by a hydrogen explosion that occurred at 3:36 p.m. on the 12th at Unit 1, the power-supply car became unusable. Furthermore, a hydrogen explosion occurred at Unit 3 at 11:01 a.m. on the 14th. The fire engine and hoses that had been completely readied were damaged and became unusable. At 1:25 p.m. that same day, the RCIC tripped. Time was required after this had been confirmed for pressure to be reduced. The water level fell, the reactor core was damaged, and at the same time hydrogen was generated.

It is presumed that hydrogen leaked into the reactor building with the damage to the pressure and primary containment vessels following the core damage, but at Unit 2, a panel on the side of the upper part of the reactor building opened due to the impact of the hydrogen explosion at Unit 1. It is surmised that for this reason, hydrogen escaped to the outside and an explosion of the reactor building was avoided.

On the other hand, we surmise that the most radioactive material to be released from any of the three buildings came from Unit 2. We presume that this is because at Units 1 and 3 the "venting"—an operation that entails the removal of a certain amount of radioactive materials via the water in the suppression pool and releasing the gas to outside the primary containment vessel—was successful. We presume that at Unit 2, in contrast, the vent line could not be thrown open, venting failed, and gas that included radioactive materials direct from the primary containment vessel leaked out.

Work being done after the loss of power (main control room for Units 1 and 2)



Connecting collected batteries to meters and gauges (main control room for Units 1 and 2)



Panel on the side of the upper part of the reactor building opened with the hydrogen explosion at Unit 1



Even after all power had been lost in the tsunami the RCIC continued to operate at Unit 2. However, depressurization took time after the RCIC tripped and conditions leading to core damage developed. As a result, while a hydrogen explosion did not occur, a large amount of radioactive material eventually was released.

Changes at Unit 2 when the earthquake happened and the tsunami struck

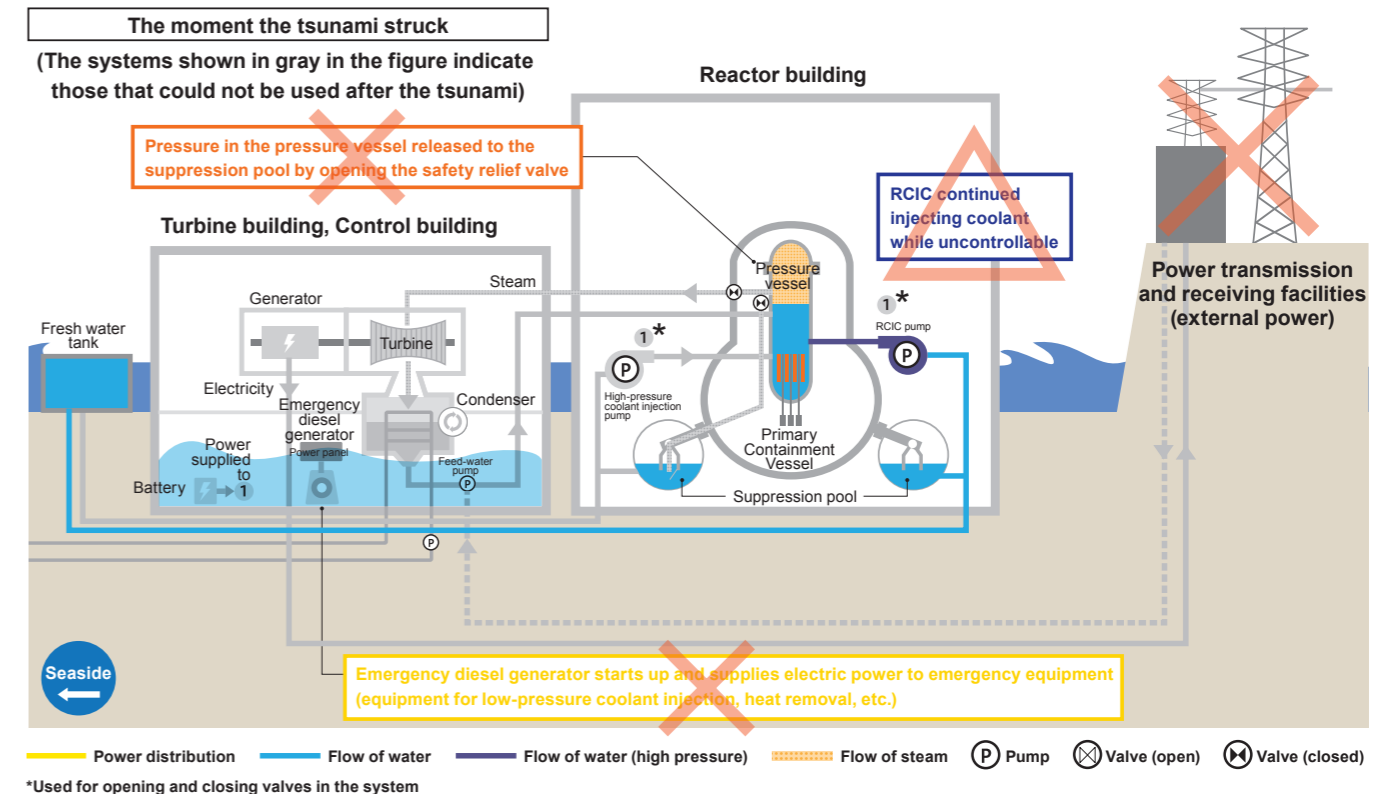
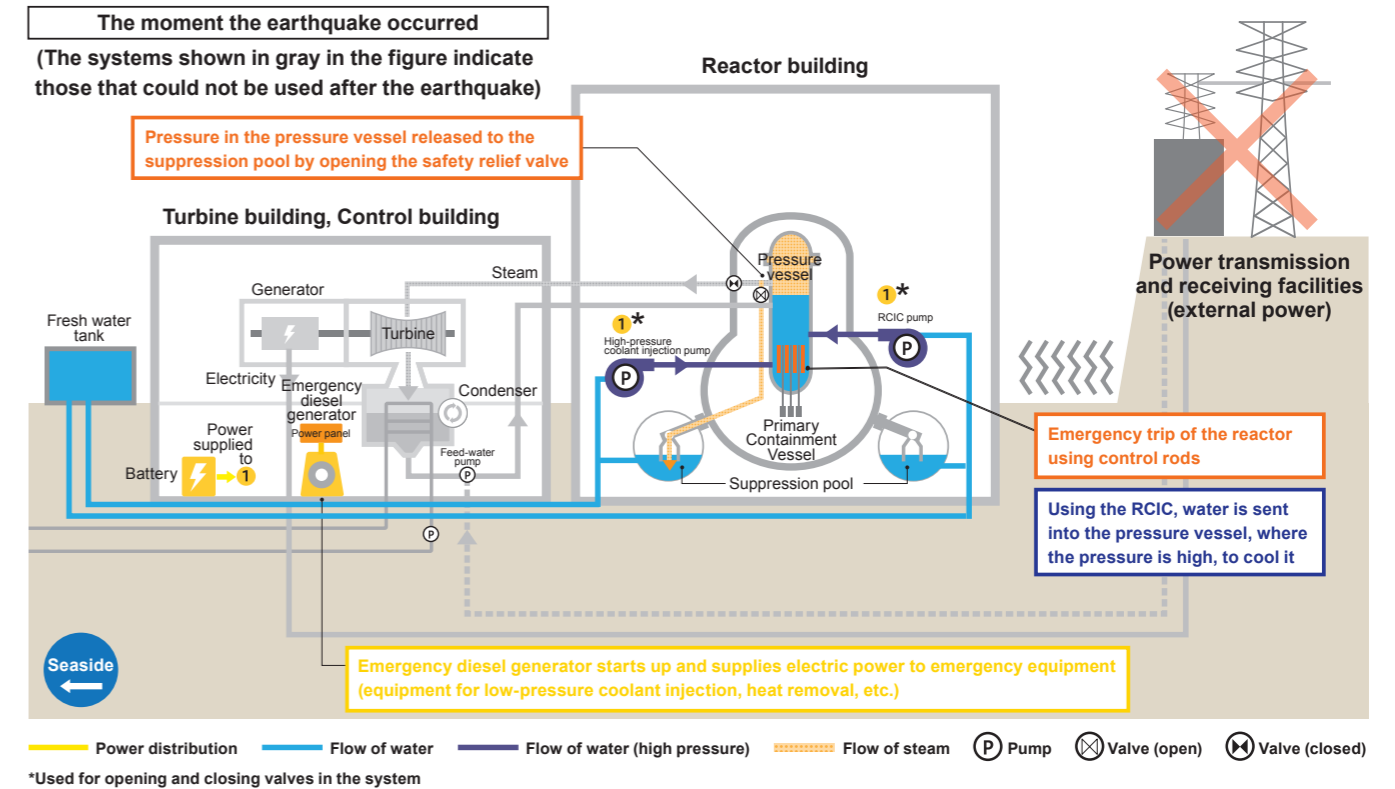

Accident issues of note (Unit 2)

Lessons from the accident	Problem(s) that arose
1: Protection from tsunami	<ul style="list-style-type: none"> The buildings and areas outside were flooded due to the tsunami.
2: Guaranteeing power sources/means of injecting coolant	<ul style="list-style-type: none"> Due to the loss of all AC and DC power, all coolant injection and heat removal functions were lost except the RCIC. At the same time, the RCIC became uncontrollable. It operated for several days, but subsequently tripped. After the RCIC tripped, time was needed to reduce the pressure of the pressure vessel. The water level fell and core damage eventually occurred.
3: Impact mitigation after core damage	<ul style="list-style-type: none"> After the core was damaged, the primary containment vessel was also damaged and both hydrogen and radioactive material were leaked to the outside.
4: Assessing the situation at the plant	<ul style="list-style-type: none"> Due to all power having been lost, the means for illumination, communication, monitoring, and measuring were lost. In addition, all units had simultaneously fallen into a crisis situation. This all produced confusion in the initial response and inadequacies in the sharing of information.
5: Improvements to the recovery work environment	<ul style="list-style-type: none"> Owing to concerns about major aftershocks and attendant tsunamis, as well as the scattering of debris due to the tsunami and the hydrogen explosions at Units 1 and 3, accessibility to the site and the capacity to do work there were reduced. The power-supply car and fire engines that had been prepared were damaged by the hydrogen explosions at Units 1 and 3. The work environment worsened strikingly owing to a lack of resources for dealing with an increase in radiation doses and for managing radiation, as well as the accident response extending to last many days.

Why did Fukushima Daiichi Nuclear Power Station end up experiencing a severe accident? The development of the accident at Unit 2

The development of the accident at Unit 2

The nuclear reactor underwent an emergency trip after the earthquake. Offsite power had been lost, but the emergency diesel generator started automatically. The RCIC was used and cooling of the reactor core proceeded. The RCIC continued to operate for about three days even after all power had been lost due to the tsunami, but on March 14, it tripped. An attempt was made to shift to low-pressure coolant injection by depressurization, but due to the impact of hydrogen explosions at adjacent plants and difficulties in moving ahead with the work, the water level in the pressure vessel dropped during the interim, the core was damaged, and conditions developed to the point of hydrogen being generated. As a result, while a hydrogen explosion did not occur, a large amount of radioactive material eventually was released.

14:46 Earthquake occurred

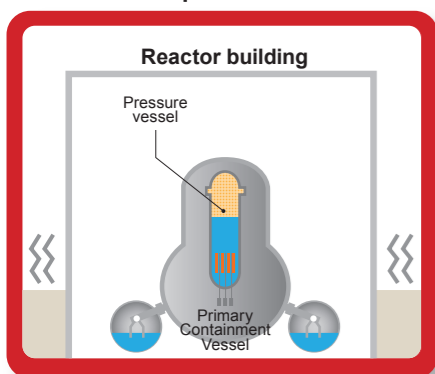

15:35 Tsunami hits

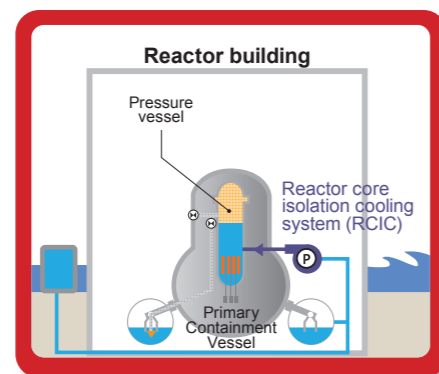

13:25 RCIC determined to have tripped

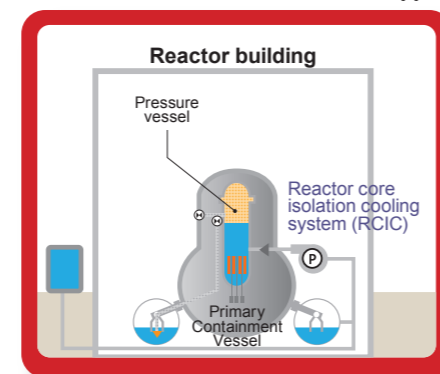

19:54 Start coolant injection

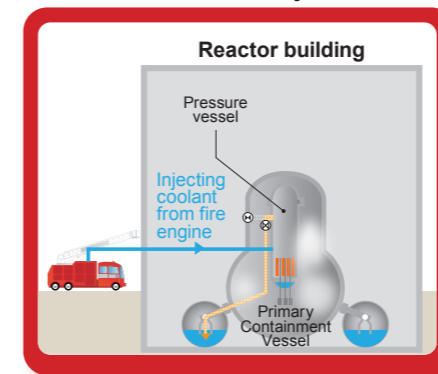

A.M. Release of radioactive materials outside reactor building

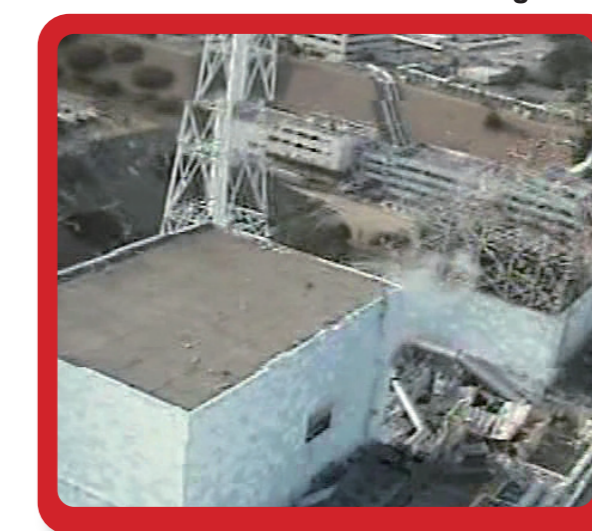

3/11

Cold shutdown process in normal conditions

Cold shutdown process in an emergency

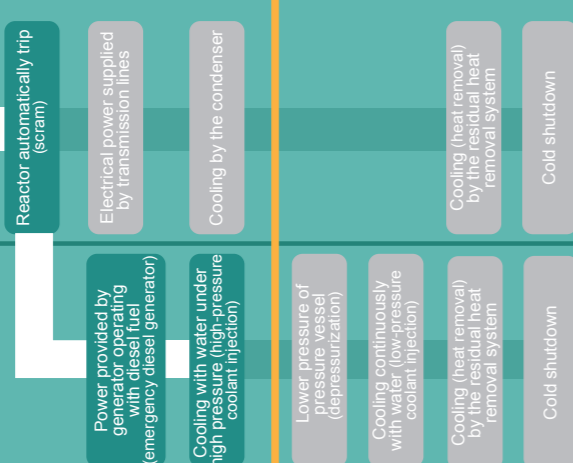

3/12

3/14

3/15

Responses and events after the tsunami occurred

Cause of core damage was failure to reduce pressure

At Unit 2 and Unit 3, after the reactor cores stopped, water levels in the reactors were maintained (the reactors cooled) owing to the operation of HPCI systems that can inject coolant into pressure vessels experiencing high pressure. However, after a certain amount of time the HPCI systems tripped and the situation was such that they could not be restarted. In such a case, it was necessary to lower the pressure in the pressure vessels, inject coolant into those vessels using the low-pressure coolant injection system, and cool the reactor cores. However, because it was not possible either to quickly open the "safety relief valve" in order to reduce pressure, or to inject coolant, water levels in the pressure vessels dropped and the reactor cores were damaged.



15:36 Hydrogen explosion in the Unit 1 reactor building (panel opened on the side of the upper part of Unit 2 reactor building)



11:01 Hydrogen explosion in the Unit 3 reactor building

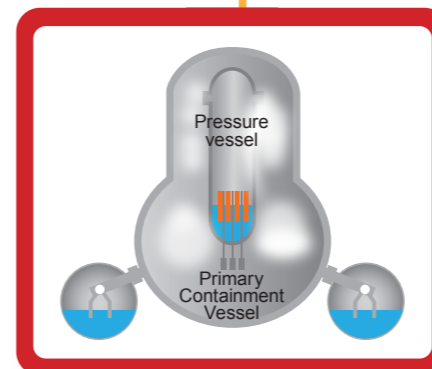

Hydrogen generation occurred

It is possible that the sequence with respect to the drop in water level, core damage, and hydrogen generation occurred in a different order due to uncertainties over the amount of coolant injected.

Why did Fukushima Daiichi Nuclear Power Station end up experiencing a severe accident?

Why did Unit 3 experience a severe accident?

The accident at Unit 3

When the earthquake occurred, the control rods were immediately inserted at Unit 3 and, as designed, the reactor automatically tripped. The situation at Unit 3 was such that it had lost all offsite power due to the earthquake and condensers and other equipment had become unusable. However, the emergency diesel generator started automatically and the reactor core isolation cooling system (RCIC) was also able to operate. All AC power was lost after this due to the tsunami striking and the attendant flooding. The DC power equipment for Unit 3 differed from Unit 1 and 2, however, in that it was installed at a slightly higher spot and so escaped flooding. For that reason, operation and control of the RCIC and HPCI could be maintained; it was also possible to continue monitoring reactor status using meters and gauges.

Coolant injection continued for approximately a day and a half, after which the HPCI system was tripped to change over to injecting coolant at low pressure (with a diesel driven fire pump). However, depressurization after this took time, the water level dropped, and the result was the generation of hydrogen and damage to the core.

Coolant injection from fire engines began after the fall in pressure had been confirmed, but owing to the hydrogen that had leaked from the primary containment vessel a hydrogen explosion occurred at 11:01 a.m. on March 14.

Seawater system pump that lost availability in the tsunami



Unit 3 reactor building after the hydrogen explosion



Accident issues of note (Unit 3)

Lessons from the accident	Problem(s) that arose
1: Protection from tsunami	<ul style="list-style-type: none"> The buildings and areas outside were flooded due to the tsunami.
2: Guaranteeing power sources/means of injecting coolant	<ul style="list-style-type: none"> The loss of all AC power caused the loss of AC-powered coolant injection and heat removal function. Once the HPCI system had tripped, depressurization in the pressure vessel took time, the water level dropped, and the result was core damage.
3: Impact mitigation after core damage	<ul style="list-style-type: none"> The hydrogen generated due to the core damage leaked from the pressure and primary containment vessels to the inside of the reactor building and a hydrogen explosion occurred.
4: Assessing the situation at the plant	<ul style="list-style-type: none"> The loss of AC power produced chaos in the initial response due to the fact that the means of lighting and communications were limited and all the units fell into a crisis situation simultaneously.
5: Improvements to the recovery work environment	<ul style="list-style-type: none"> Due to concerns about major aftershocks and attendant tsunami, as well as the scattering of debris, accessibility to the site and the capacity to do work there were reduced. The work environment worsened strikingly owing to a lack of resources for dealing with an increase in radiation doses and for managing radiation, as well as the accident response extending to last many days.

Injecting coolant continued at Unit 3 using the HPCI system even after the tsunami. However, depressurization took time after the HPCI system tripped and conditions that led to core damage developed. The hydrogen generated attendant with the core damage leaked into the reactor building and a hydrogen explosion occurred in that building.

Changes at Unit 3 when the earthquake happened and the tsunami struck

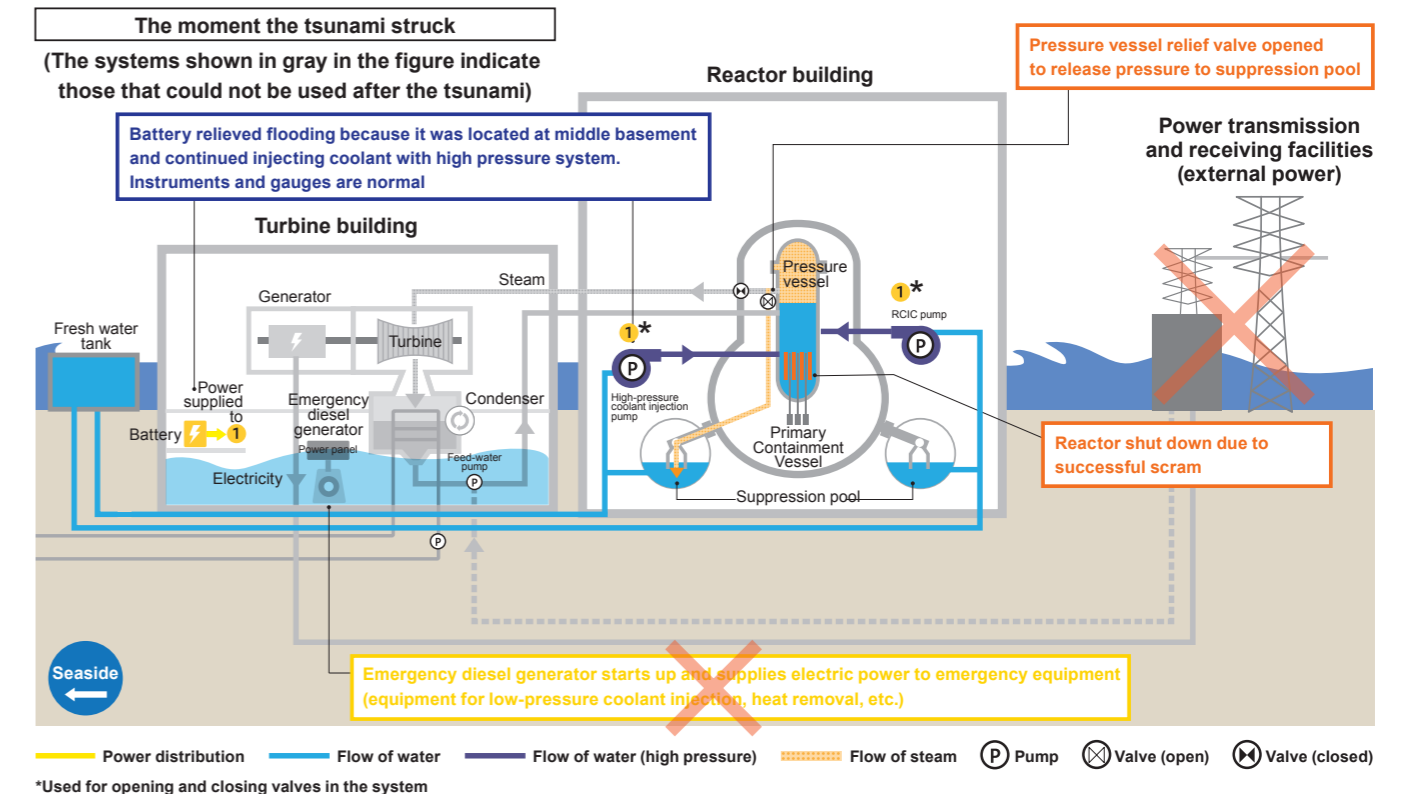
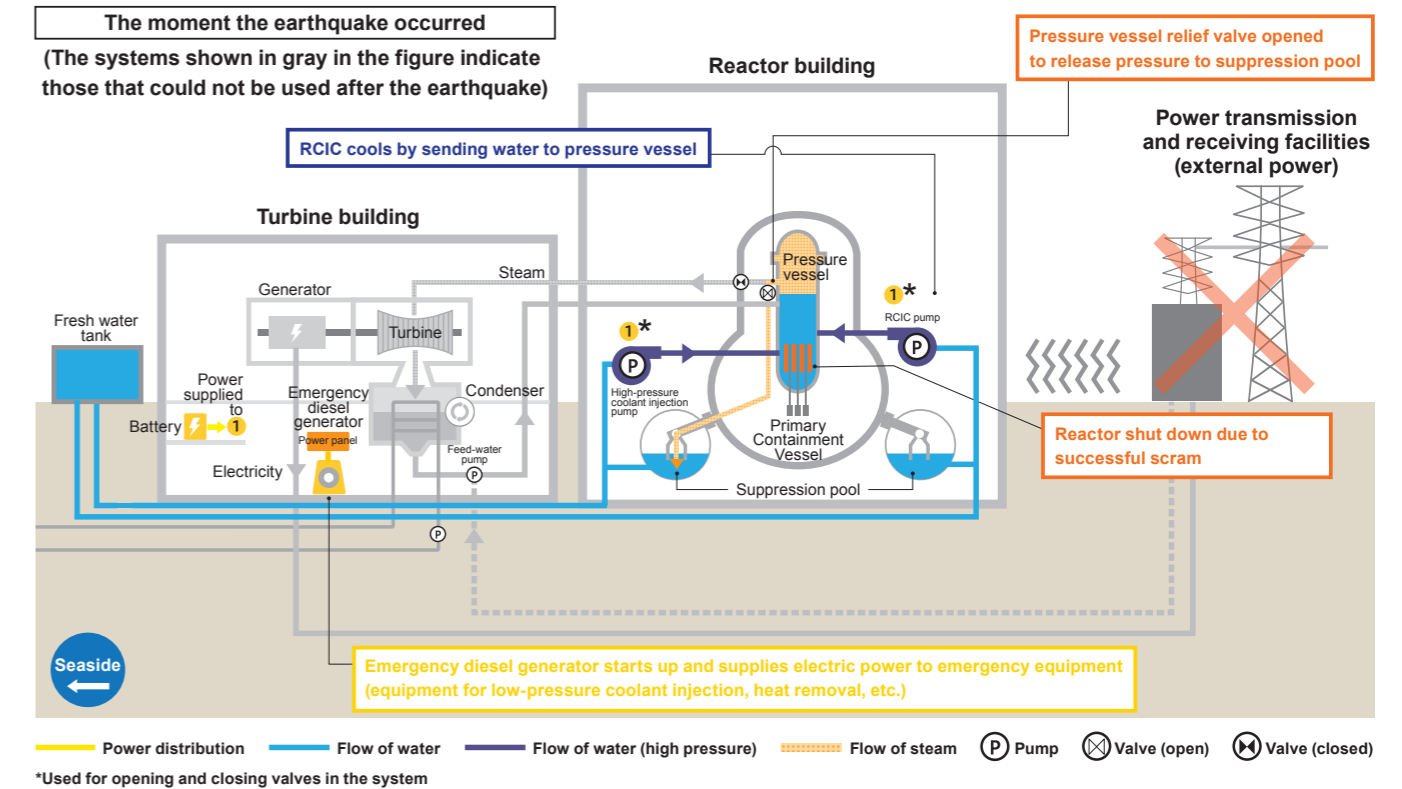

The development of the accident at Unit 3

The nuclear reactor underwent an emergency trip after the earthquake. Offsite power had been lost, but the emergency diesel generator started automatically. The RCIC was used and cooling of the reactor core proceeded. The emergency diesel generator tripped due to the tsunami. However, the batteries (DC power) relieved damage and so it was possible to control the RCIC and HPCI and continue cooling. A shift to low-pressure coolant injection was attempted in parallel with tripping the HPCI system, but depressurization in the pressure vessel did not go well and moving ahead with the work became difficult. During this time, the water level in the pressure vessel dropped, the reactor core was damaged, conditions developed to the point of hydrogen being generated, and at 11:01 a.m. on March 14 a hydrogen explosion occurred in the reactor building.

14:46 Earthquake occurred

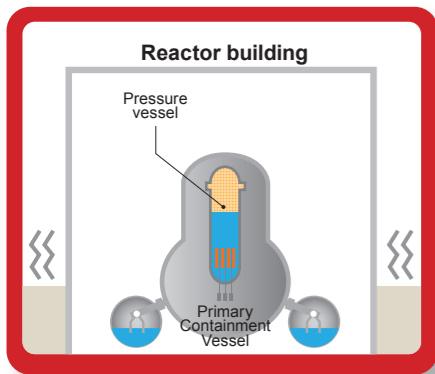

15:35 Tsunami hits

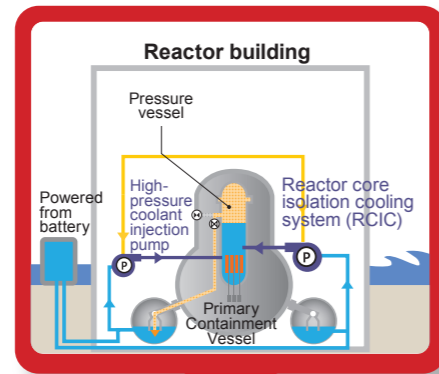

Water level inside the pressure vessel dropped

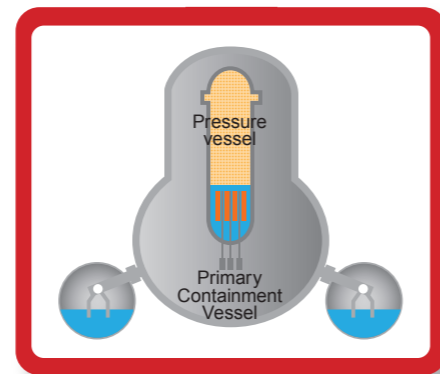

About 9:25 Start coolant injection

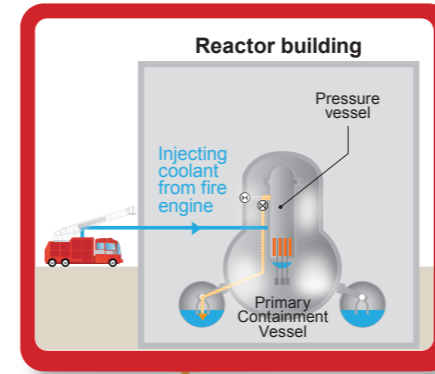

11:01 Hydrogen explosion in the Unit 3 reactor building



3/11

Reactor automatically trips (scram)

Electrical power supplied by transmission lines

Cooling by the condenser

3/12

3/13

3/14

Cold shutdown process in normal conditions

Cold shutdown process in an emergency

Power provided by generator operating with diesel fuel (emergency diesel generator)

Cooling with water under high pressure (high-pressure coolant injection)

Lower pressure of pressure vessel (depressurization)

Cooling continuously with water (low-pressure coolant injection)

Cooling (heat removal) by the residual heat removal system

Cold shutdown

HPCI continued (use battery)

Switch to HPCI system from RCIC system

Loss of cooling, coolant injection and depressurization functions (battery runs out)

Fuel exposure and damage (heating while empty conditions)

Pressure vessel damage

Container vessel damage

Hydrogen leaks into building

Responses and events after the tsunami occurred

It is possible that the sequence with respect to the drop in water level, core damage, and hydrogen generation occurred in a different order due to uncertainties over the amount of coolant injected.

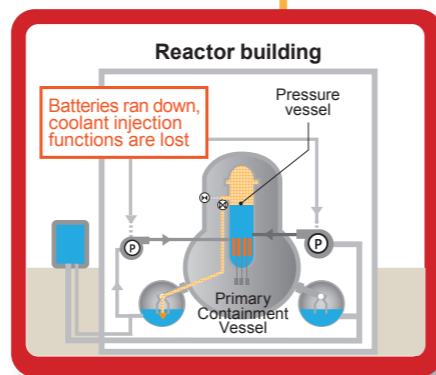

2:42 Trip the HPCI system

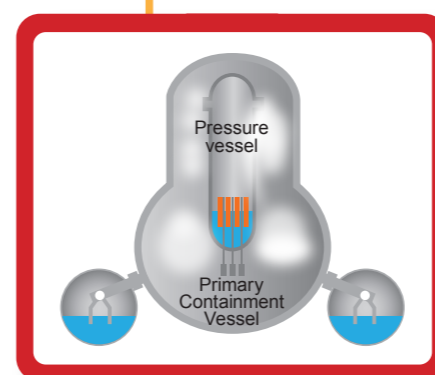

Hydrogen generation occurred

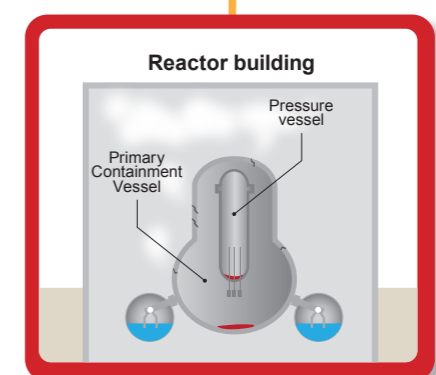

Hydrogen leaked into the building

Valve (closed) Valve (open) Pump
Flow of water Flow of water (high pressure) Flow of steam

Why was there a hydrogen explosion at Unit 4?

The accident at Unit 4

Unit 4 was undergoing regular inspection and operation had been stopped when the earthquake occurred, with all the fuel for the reactors having been moved to the spent fuel pool. The tsunami resulted in a total power failure. Both heat removal and coolant injection functions for the spent fuel pool were lost, and the drop in water levels at the spent fuel pool due to evaporation produced concerns. As of 4:08 a.m. on March 14 the water temperature of the spent fuel pool was confirmed to be 84°C, and the water level was forecast to drop to the upper tips of the fuel in late March.

For that reason, it was recognized that there was some leeway time-wise, but then, at 6:14 a.m. on March 15, a hydrogen explosion occurred in the reactor building of Unit 4. It is presumed that this is the reason why, attendant with the venting of the Unit 3 primary containment vessel, vented gases including hydrogen flowed into Unit 4 through the exhaust pipes.

Unit 4 reactor building after the hydrogen explosion



Conditions at the Unit 4 spent fuel pool, photographed June 29, 2011



Unit 4 was not in operation because planned outages were being conducted, but a hydrogen explosion occurred in the reactor building in the early morning on March 15. The cause is presumed to have been hydrogen generated at Unit 3 that flowed into Unit 4 through the exhaust pipes.

Changes at Unit 4 when the tsunami struck

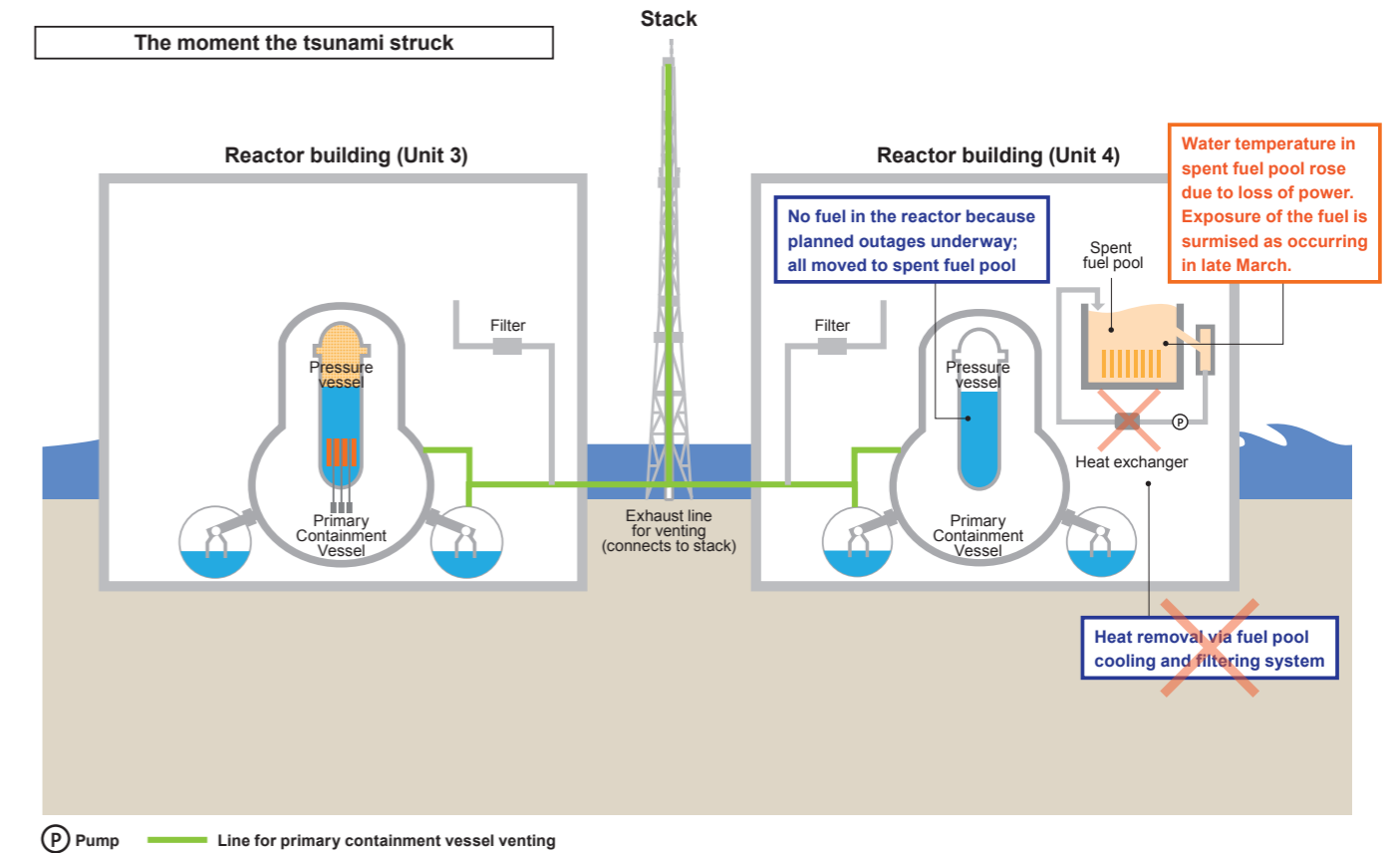

Accident issues of note (Unit 4)

- **Guaranteeing power sources/means of injecting coolant:** all power was lost due to the earthquake and tsunami, and the means for injecting coolant and cooling the spent fuel pool were lost. Furthermore, dealing with the spent fuel pool had to be done in parallel with dealing with the reactors for the other units.
- **Impact mitigation after the accident:** hydrogen explosion occurred due to an inflow of hydrogen from Unit 3.

Reinforcement of Unit 4 spent fuel pool

The spent fuel pool was made with steel-reinforced concrete measuring 140 to 185 cm thick. For that reason, although the exterior walls were damaged at Fukushima Daiichi Unit 4, it has been confirmed that there has been no change from before the earthquake in the spent fuel pool's seismic resistance ability. Even if another earthquake of the same strength as the Great East Japan Earthquake occurred (strong 6 on the Japanese scale) no problems in safety terms would arise.

However, to further improve safety construction, the bottom of the pool was reinforced with steel posts and concrete walls, improving seismic tolerance by 20% (Completed in July 2011).

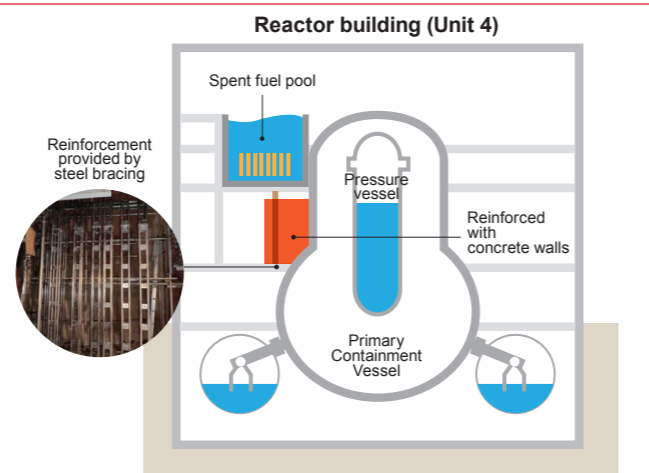

Inflow route of hydrogen into Unit 4

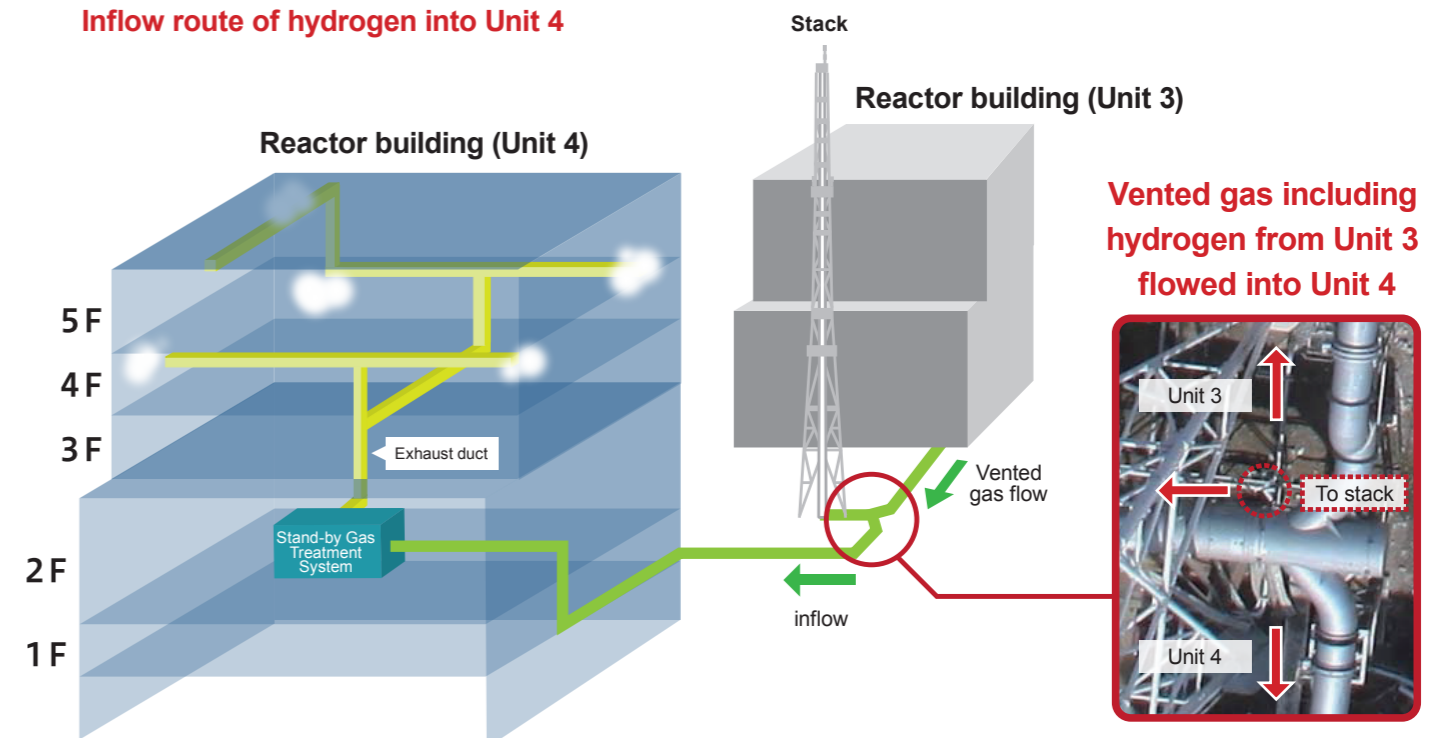

Changes in the reactor building (Unit 4)

Offsite power was also lost due to the earthquake at Unit 4, which was not in operation because planned outages were underway. After the tsunami struck, it was no longer possible to use the emergency diesel generator and all power was lost. Due to the loss of cooling and resupply functions attendant with the loss of power, there were worries about the drop in water level caused by the evaporation of water in the spent fuel pool, where the fuel was being stored. However, it was forecast that the fuel would not become exposed above the water's surface until late March. For that reason, it was recognized that there was some leeway time-wise for responding, but then a hydrogen explosion occurred in the reactor building due to an inflow of hydrogen into the Unit 4 reactor building through the vent lines attendant with the venting at Unit 3.

14:46 Earthquake occurred

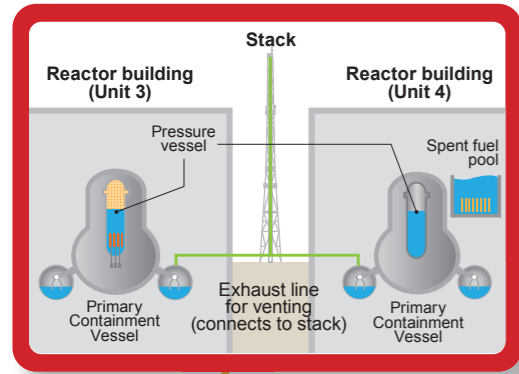

15:35 Tsunami hits

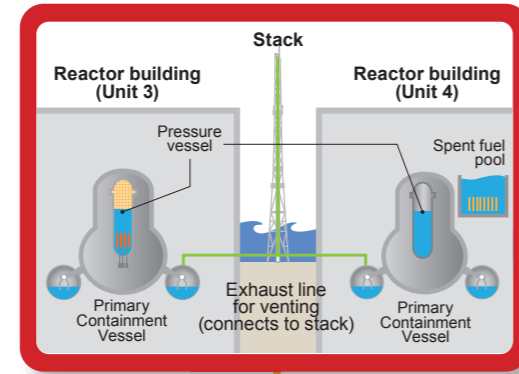

Power lost due to tsunami
Coolant functions and ability to resupply water lost

Rise of water temperature in spent fuel pool

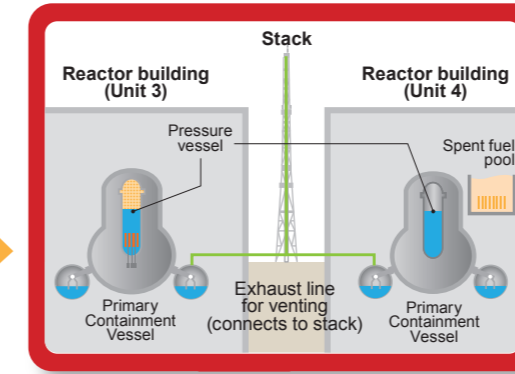

The water temperature of the spent fuel pool confirmed to be 84°C; fuel forecast to be exposed above the water's surface in late March.

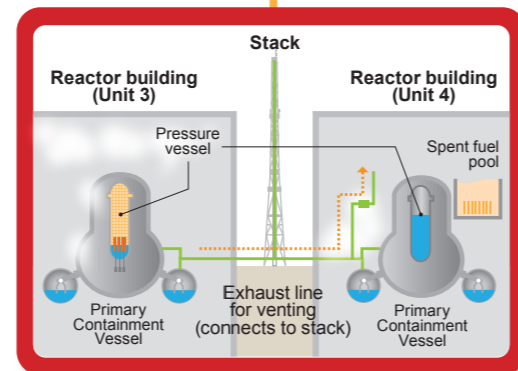
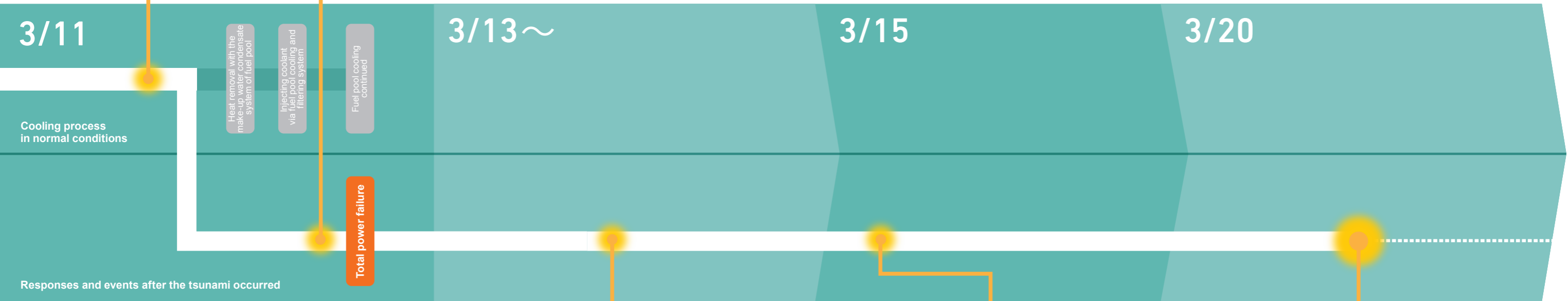

Hydrogen inflow from Unit 3



Around 6:14 a.m. Hydrogen explosion in the Unit 4 reactor building

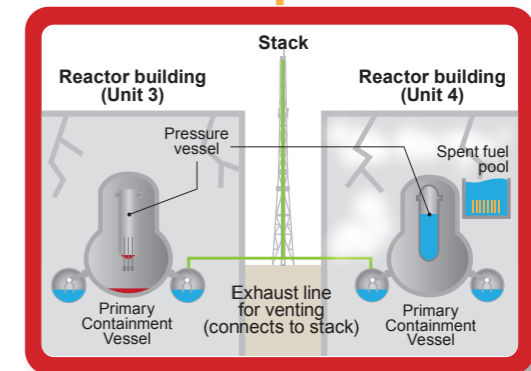

8:21 Begin injecting coolant into spent fuel pool

Why did Fukushima Daiichi Nuclear Power Station end up experiencing a severe accident?

The magnification of damage due to simultaneous accidents at Units 1 to 4

In the Fukushima nuclear accident, multiple reactors experienced disasters simultaneously, leading to the accident. This created a situation in which responses had to be pursued in parallel. In addition, the progression of the accident at one unit hindered the responses at the other ones.

Simultaneous problems at four units

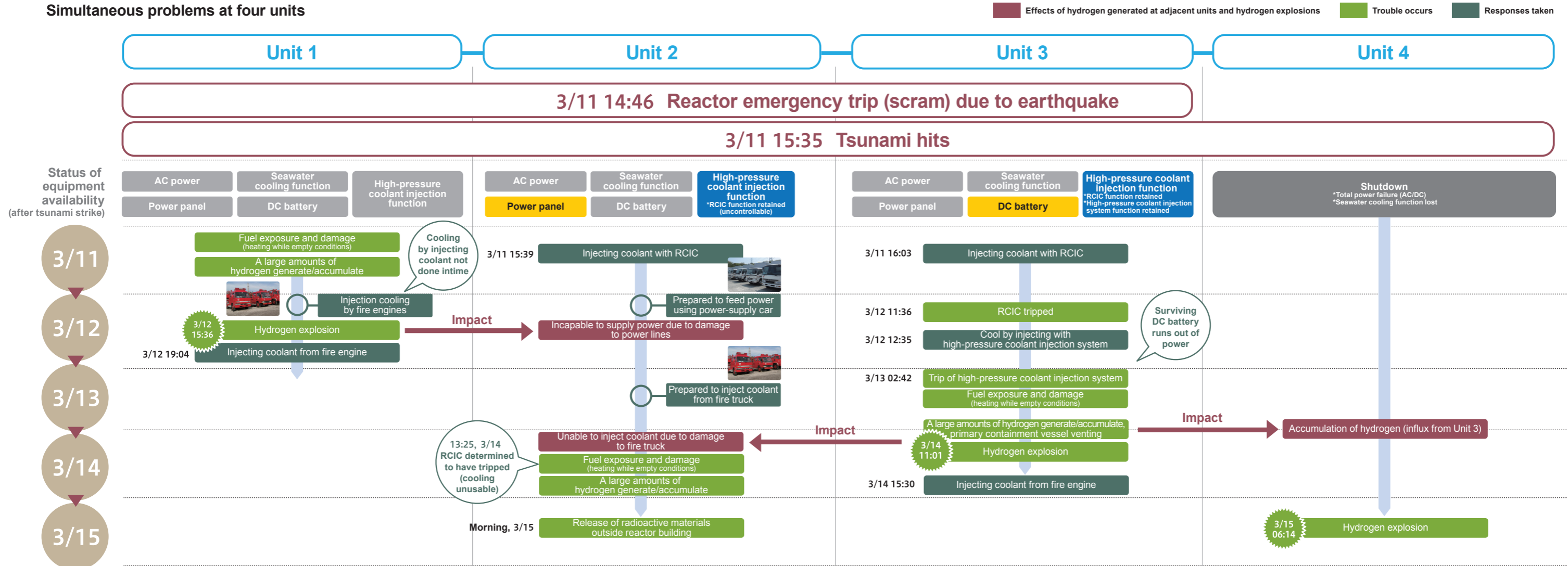

Accident at adjacent reactor produces expansion of damage

The situation after the tsunami was most urgent at Unit 1, where both coolant injection and heat removal had been interrupted. Preparations were being made to inject coolant into Unit 1 using fire protection lines and fire engines, but coolant injection did not happen in time. The water level in the reactor dropped, leading to the generation of hydrogen and eventually core damage. Also, the hydrogen that was generated leaked into the reactor building and, approximately one day after the tsunami at 3:36 p.m. on March 12, a hydrogen explosion occurred. The hydrogen explosion at Unit 1 damaged the power lines that had been laid down at Unit 2 as well as the power lines being readied at Unit 3. This had a big impact on the work being done to restore power at both Units 2 and 3.

Depressurization required more time at Unit 3 after the HPCI system tripped. The water level fell, leading to the generation of hydrogen and eventually core damage. Also, the hydrogen that was generated leaked into the reactor building and, approximately 67 hours after the tsunami at 11:01 a.m. on March 14, a hydrogen explosion occurred.

The fire engines and hoses being readied at Unit 2 were damaged by the hydrogen explosion at Unit 3 and could no longer be used. Additionally, the RCIC system tripped about two hours after the hydrogen explosion at Unit 3. Depressurization took more time following this, the water level dropped, and this eventually led to core damage.

At Unit 4, hydrogen discharged with the venting of the primary containment vessel at Unit 3 flowed into the reactor building and brought about a hydrogen explosion. In this way, one of the lessons learned from the events is that the progression of the accident at one unit had a big impact on restoration work at the other units.

The damage at Fukushima Daiichi Nuclear Power Station Units 1-4, photographed March 19, 2011

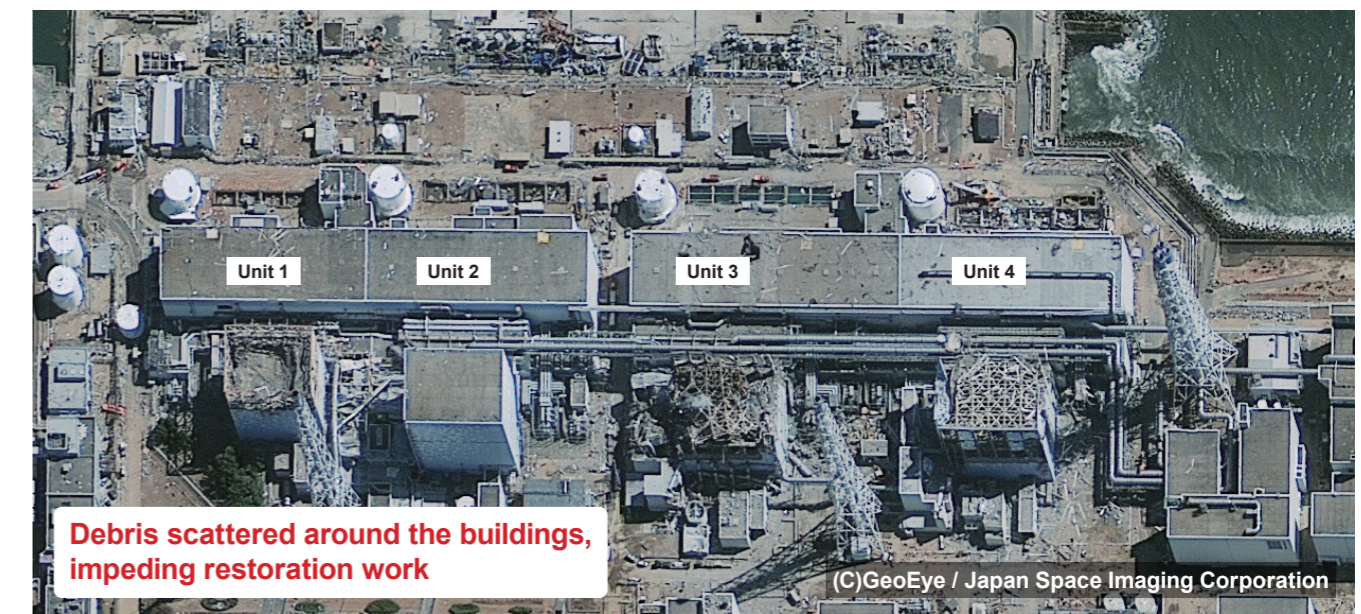

Why did Fukushima Daiichi Nuclear Power Station end up experiencing a severe accident?

Why did Fukushima Daini Nuclear Power Station escape a severe accident?

Course of responses at Fukushima Daini Nuclear Power Station

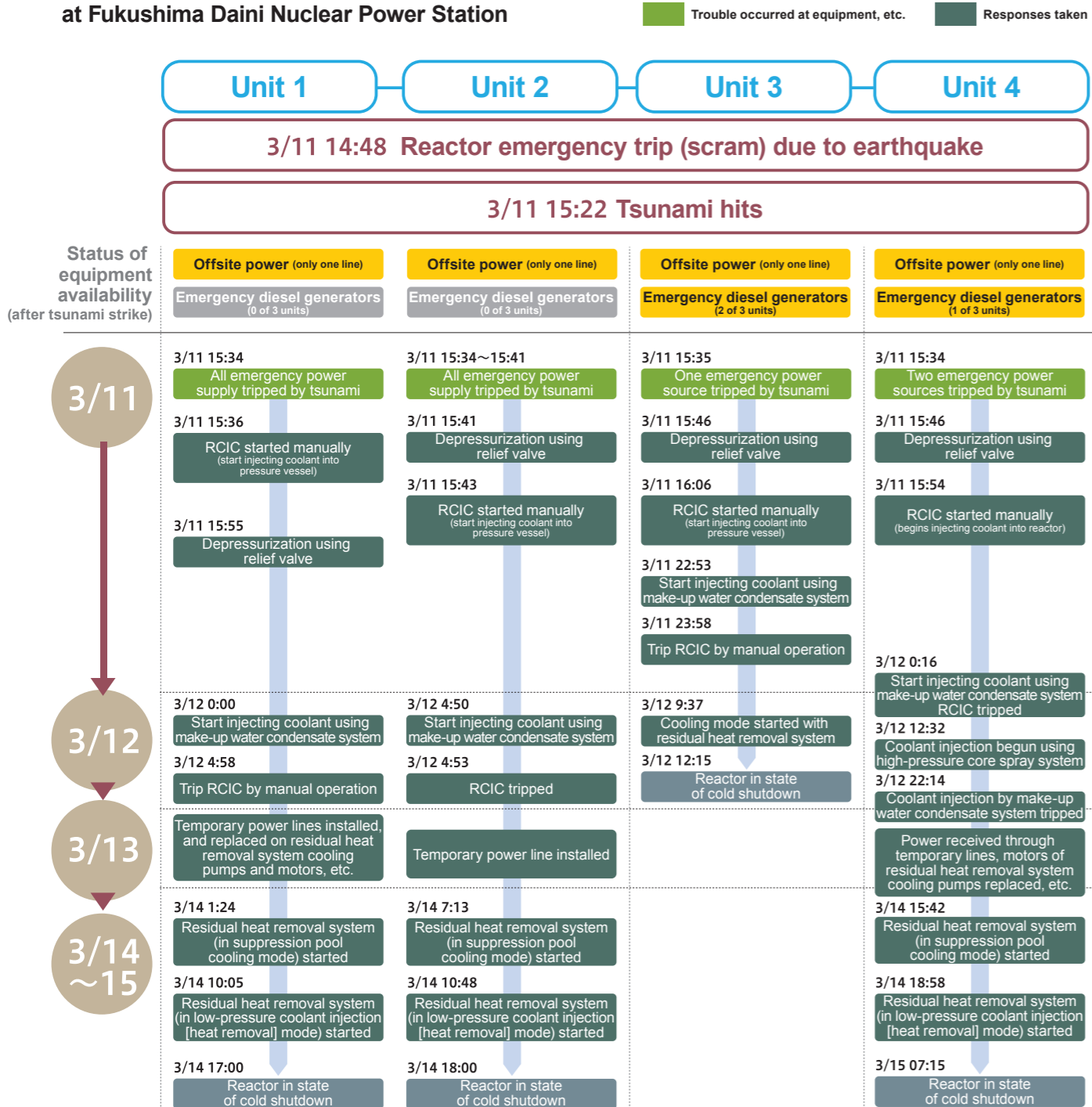

Venting preparations moved forward

At Fukushima Daini Nuclear Power Station, heat removal functions were lost at Units 1, 2, and 4 due to the tsunami. Coolant was injected and the reactor cores were cooled, but there was no place for the steam (heat) generated by this to escape and the pressure in the primary containment vessels gradually rose. For that reason, preparations were made to vent the primary containment vessels at each unit. However, thanks to the success of the efforts to restore heat removal function that were taking place in parallel, workers were able to achieve cold shutdowns without having to perform venting.

Fukushima Daini Nuclear Power Station Units 1, 2, 3, and 4 were all able to receive AC power of some sort even after the tsunami. Also, it was possible to put all of the units into cold shutdown by changing the motors of seawater pumps that had been damaged and laying down temporary cables to the motors while coolant was being injected.

Responses at Fukushima Daini Nuclear Power Station

Like Fukushima Daiichi Nuclear Power Station, Fukushima Daini Nuclear Power Station was damaged by the earthquake and tsunami. However, the situation did not reach the point at which the cores were damaged, and all units achieved cold shutdown. The reason that can be offered as to why this was the case is that even after the earthquake and tsunami, offsite power sources and AC-power equipment could still be used and the reactors could be cooled.

On the other hand, it was not possible to remove heat from the reactors because the seawater pumps were damaged by the tsunami.

For that reason, cooling of the pressure and primary containment vessels was carried out as the occasion demanded by, for example, making use of systems that did not require the support of the seawater pumps, such as the RCIC and the make-up water condensate system. By restoring power to the seawater pumps, achieved by replacing damaged seawater pump motors and laying temporary cables during that period, it became possible to remove heat and workers were able to bring all units into cold shutdown.

Much flooding occurred at Units 1 and 2 due to their being upstream, where the tsunami waters concentrated

Luckily, the area where the main buildings are located at Fukushima Daini Nuclear Power Station stands 12 meters above sea level, and also, the tsunami that hit was lower compared to that at Fukushima Daiichi Nuclear Power Station, so the tsunami damage was lighter at Daini than it was at Daiichi. Unit 1 suffered the greatest damage of the four units lined up at Fukushima Daini.

This was because a road runs along the south side of the area where the main buildings are located at Unit 1, and the tsunami waters traveled up along this road in a concentrated fashion.

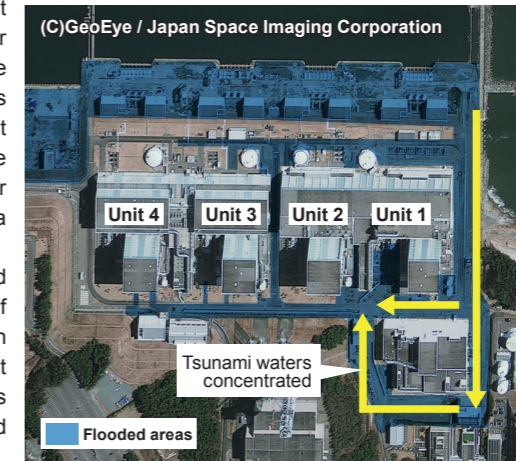

After tsunami caused damage (overall view) Fukushima Daini Nuclear Power Station, photographed March 18, 2011

Conditions upstream of where tsunami concentrated



Door wrecked by water pressure



Work being done to replace seawater system pump motors (photographed following day)



Issues of note in escaping any accident (Fukushima Daini Nuclear Power Station)

- The earthquake and tsunami caused a great deal of damage. However, offsite power sources and AC-powered equipment could still be used and it was possible to provide electricity to some equipment.
- Most of the emergency coolant injection equipment needed for cooling could not be used owing to damage to the seawater pumps and so forth, but normal coolant injection equipment not needed for heat removal was put to use as the occasion demanded and cooling of the reactors continued.
- The seawater pumps and so forth were successfully restored during the time it took for steam (heat) to accumulate in the primary containment vessels. For that reason, it was possible to remove heat to the sea before gas was released into the open air by venting the primary containment vessels.

Why did Fukushima Daiichi Nuclear Power Station end up experiencing a severe accident? Comparison of units with core damage and units in cold shutdown

Despite the fact that they were damaged by the earthquake and tsunami like Fukushima Daiichi Nuclear Power Station Units 1-4, Units 5 and 6 at that station, as well as Fukushima Daini Nuclear Power Station, escaped a severe accident. What were the differences in these cases?

Comparative view of equipment damage situation after the tsunami struck
(Fukushima Daiichi: Units 1-6, Fukushima Daini: Units 1-4)

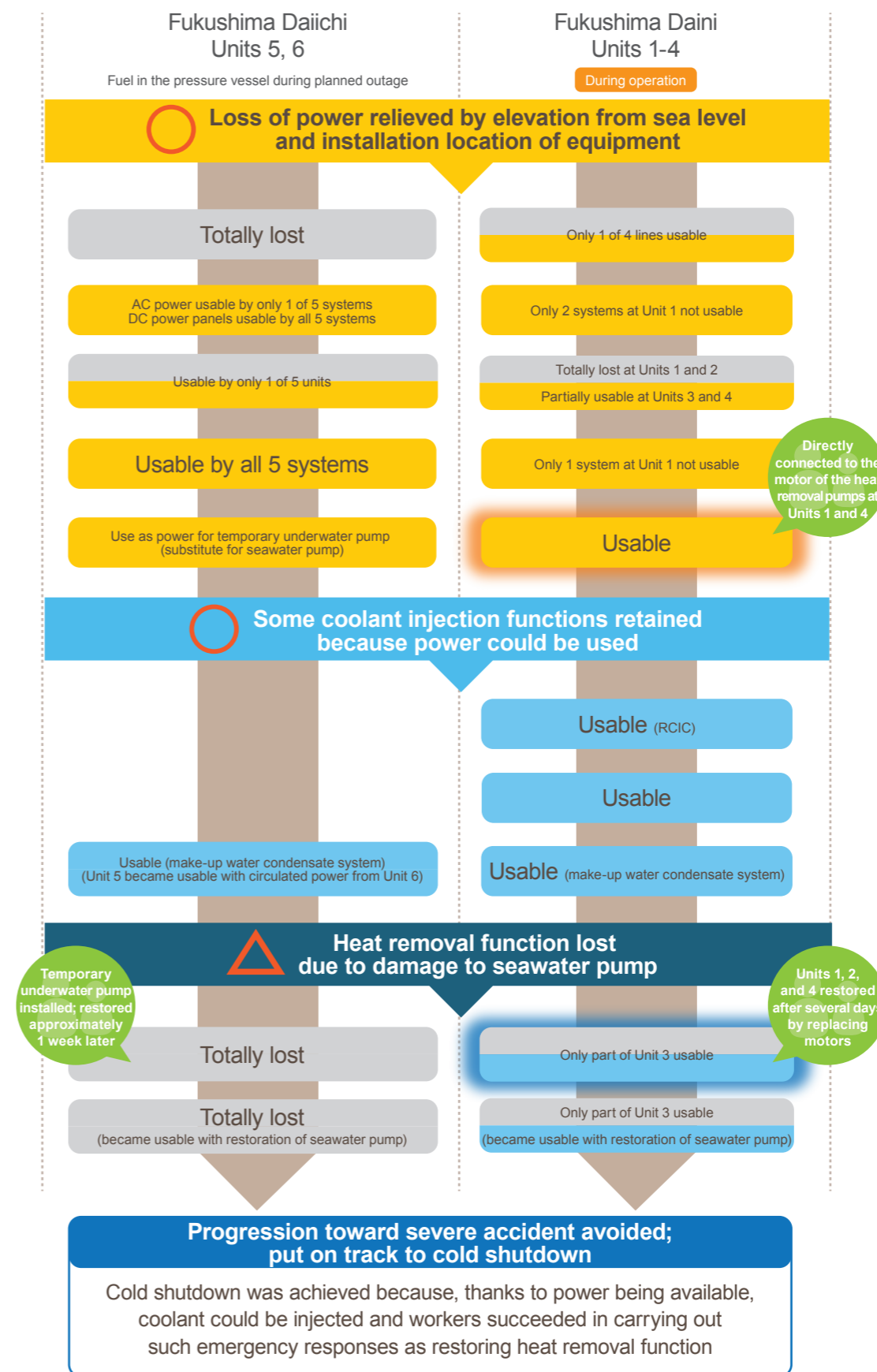
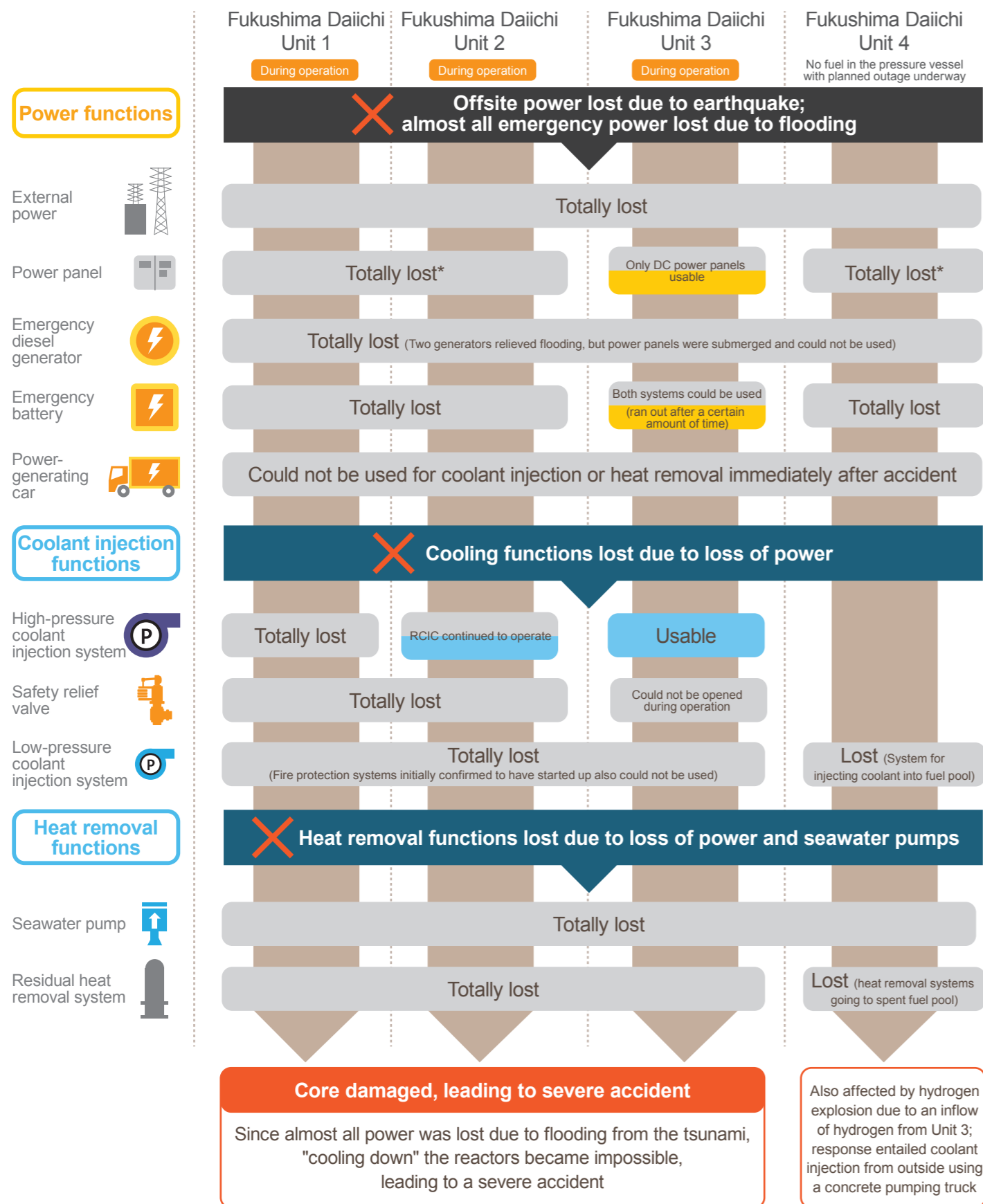

Lessons learned

Importance of power functions

Importance of cooling and heat removal functions

Lessons obtained from the accident and future responses

Work is being done to apply the lessons from the accident at Fukushima Daiichi Nuclear Power Station in order to fortify and promote safety measures based on the philosophy of defense in depth so that, no matter what kind of situation may arise, conditions do not once again reach the point of becoming a severe accident.

Defense in depth is a philosophy in which one prepares countermeasures corresponding to the various stages of a situation.

[Using an automobile accident by way of example...]

(1) Maintain brakes and tires so that trouble does not occur

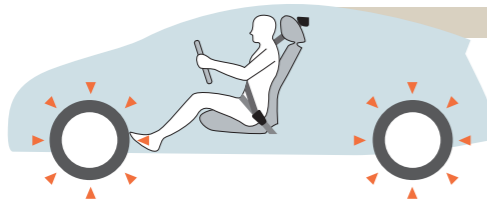

(2) Emergency brakes and automatic braking systems to prevent accidents



(3) Seatbelts and airbags that prevent injuries after an accident

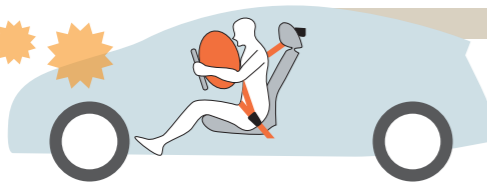

(4) Flares and rescue activities to reduce impact (secondary disasters, etc.) after an accident

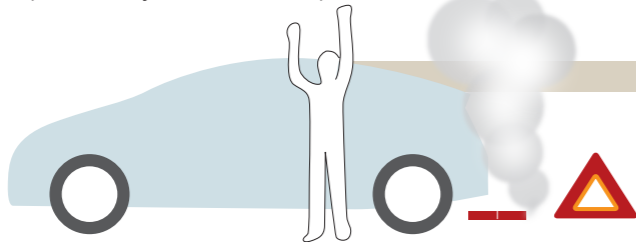

Countermeasures employed based on the defense in depth philosophy and lessons learned from the accident.

Lesson Defenses against tsunami were weak.
Countermeasures Thoroughgoing tsunami countermeasures will be implemented, such as working to make buildings watertight and constructing flood barriers and seawalls to reduce flooding on station grounds and the impact on facilities, even if a tsunami more powerful than that conceived at the design stage strikes.

This corresponds to the ability to stop nuclear reactors using control rods. There were no problems when it came to making emergency trips at either Fukushima Daiichi or Fukushima Daini.

Lesson The means for injecting coolant in the event of total power loss had not been sufficiently prepared.
Countermeasures

- A variety of power sources have been prepared and power supply capabilities beefed up, such as by stationing power-supply cars on high ground unlikely to be affected by tsunami and making it possible to use DC power (batteries) for a long period of time.
- Sources of water required for coolant injection in an accident have been increased by, for example, constructing reservoirs.
- New procedures and means for injecting coolant will be prepared and the means for injecting coolant at high pressure bolstered.
- The means for reducing the pressure of pressure vessels will be strengthened by making it possible to securely operate safety relief valves.
- The means for injecting coolant at low pressure will be bolstered by, for example, stationing fire engines on high ground unlikely to be affected by a tsunami.
- The means for removing heat will be strengthened by, for example, stationing mobile heat exchanger trucks on high ground unlikely to be affected by a tsunami.

Lesson The means for mitigating the impact after core damage had not been sufficiently prepared.
Countermeasures The means for mitigating the impact after core damage occurs will be strengthened by, for example, outfitting the interior of primary containment vessels with the means to cool them and installing venting equipment with filters in order to reduce the release of radioactive materials after an accident.

Plus
Lesson The means for handling responses—limited lighting and means of communication, the loss of means for monitoring and measuring, and a worsening working environment—had not been sufficiently prepared.
Countermeasures Measures to improve the working environment will be implemented, such as guaranteeing power for monitoring and measuring equipment in use, securing access roads to the scene after an accident occurs, and reinforcing the means of communication so that restoration work can be speedily carried out.

What is defense in depth at a nuclear power station?

Defense in depth is a philosophy in which one groups safeguards and provisions into various stages. At a nuclear power station, defense in depth provides the foundation for maintaining safety. As the above illustration shows, measures have been devised as stage 1 for preventing trouble from occurring. Measures are also put in place for subsequent stages based on the idea that the measures for the previous stage may fail. This is to prevent any trouble that may occur from developing into an accident, and to prevent damage to a reactor core even if an accident should develop.

Initiatives aimed at maintaining safety at Fukushima Daiichi Nuclear Power Station

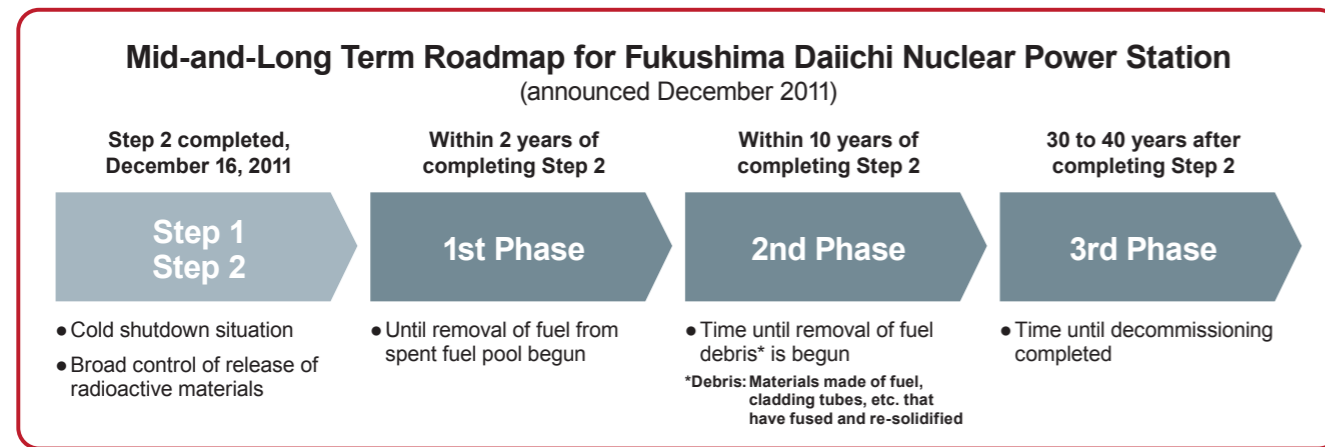

To guarantee safety for the mid-to-long term at Fukushima Daiichi Nuclear Power Station Units 1-4, TEPCO has put together a roadmap comprising objectives and schedules for work including decommissioning. The roadmap was approved by the Government-TEPCO Mid-to-Long Term Response Council in December 2011. The Roadmap is based on the principles of guaranteeing safety and transparency, and continuous reassessment of the roadmap itself. It also lays out as clearly as possible the timeline for carrying out various operations and countermeasures over the three-year period following cold shutdown. At present, work is being done to keep the reactors cooled, to continue to stably process standing water, to prevent the spread of ocean contamination, and to reduce the radiation dosages from the radioactive waste produced after the accident.

• **Mid-and-Long Term Roadmap for Decommissioning Fukushima Daiichi Nuclear Power Station Units 1-4**
<http://www.tepco.co.jp/nu/fukushima-np/roadmap/conference-j.html>

TEPCO's efforts toward maintaining safety in the future

Up to this point, we have discussed the development of the accident that occurred at Fukushima Daiichi Nuclear Power Station and the issues and lessons from that accident. Currently at TEPCO, we are reflecting on the Fukushima nuclear accident. We have also established a new structure in the company with the president at the top, and are engaged in reforms related to a variety of issues in the Nuclear Power Division, such as safety culture, safety measures, disaster prevention, risk and crisis management, the public release of information, and risk communications. We are making steady progress on these nuclear reforms, and are seeking to achieve safety standards that match the highest in the world.

• **Efforts toward nuclear reform**
http://www.tepco.co.jp/nu_reform/index-j.html



Currently, safety measures of all kinds are being implemented at our nuclear power stations based on the lessons learned from the accident.

These measures are discussed in the 'Equipment Countermeasures Section' of the "Safety Measures at Kashiwazaki-Kariwa Nuclear Power Station".

Regarding the release of information

Information related to the accident at Fukushima Daiichi Nuclear Power Station has been made available at our website, including the current status of each unit at the Fukushima Daiichi and Daini power stations, video reports on the status of the accident, accident investigation reports, and the Mid-and-Long Term Roadmap toward the Decommissioning of Fukushima Daiichi Nuclear Power Station Units 1-4.

The screenshot shows the TEPCO website header with the company logo and navigation links. The main content area features a large image of workers in protective suits at the Fukushima Daiichi Nuclear Power Station. Below the image is a caption: "We are committed to dealing with the accident at Fukushima Daiichi Nuclear Power Station and tackling the various issues in its aftermath, applying technologies and know-how gained from inside and outside Japan, in order to realize the plant's decommissioning."

• **Decommissioning Plan of Fukushima Daiichi Nuclear Power**
<http://www.tepco.co.jp/en/decommision/index-e.html>

*The URLs shown are current as of July 2014. They may change in the future.