

Relocation behavior of molten fuel to below the core

1. Introduction

Figure 1.1 shows the structures in the core region and below the core of a BWR plant. The core region and the region below the core are partitioned by a core plate. Surrounding the core plate are complex structures, as seen in the figure, with the presence of structural parts including the pipes for control rod insertion.

Versions of MAAP (up to version 4) (hereafter MAAP4) used a conventional relocation model of molten fuel in which the molten fuel accumulated on the core plate and started to relocate to below the core by melting the core plate [2, 3, 4]. The MAAP4 analysis of the accident at Unit-1 of the Fukushima Daiichi Nuclear Power Station (FDNPS) showed a sharp spike of reactor pressure at around 22:00 on March 11th. This sharp pressure increase was caused by the conventional relocation model predicting that a large amount of steam was generated upon instant relocation of molten fuel to below the core after having accumulated on the core plate. Such results were obtained by the MAAP4 because the relocation model in the code had been developed based on the TMI (PWR) accident.

On the other hand, the BWR core plate has various components surrounding it, such as fuel supports, control rod drive guide tubes (CRGT) and the shroud in the outer shell (Figure 1.1). Therefore, there could be several alternative paths for molten fuel to relocate to below the core even with no damage of the core plate. Consequently, the molten fuel could have relocated to below the core via more than a single path. Instant relocation of molten fuel to below the core after having accumulated on the core plate that was seen in the MAAP4 analysis can be considered less possible. But it has not been clarified yet which paths the molten fuel took to relocate.

This document examined the molten fuel relocation behavior to below the core for Units-1, -2 and -3 of the FDNPS, in order to facilitate clarification of the accident progression and estimation of the conditions of the core and PCV for each unit. For the examination, surveys were made of previous test studies relevant to the molten fuel relocation behavior to below the core as well as the latest research upgrading analysis codes.

The examination of the issue of molten fuel relocation to below the core is identified as Common/Issue-6 in Attachment 2.

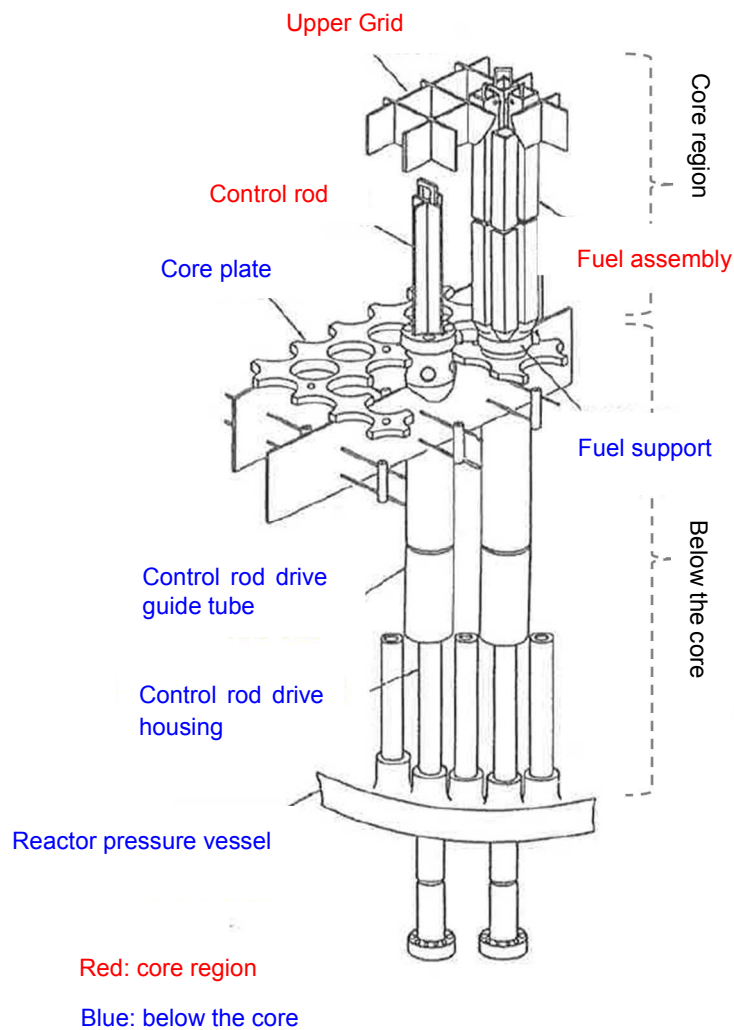

Figure 1.1 Illustration of a BWR core and lower core structure [1]

2. Relocation paths of molten fuel to below the core reviewed in relevant previous tests and the latest research

Five relocation paths of molten fuel to below the core can be considered feasible. Figure 2.1 shows four of them, which were considered relevant, from previous test studies [5, 6] and the latest research¹. In the fifth possible path the molten fuel relocates in the radial direction,

¹ Various investigations were carried out under the sponsorship of the Agency of Natural Resources and Energy of the Ministry of Economy, Trade and Industry, in the project "Investigation of in-reactor conditions by the use of severe accident analysis code, Preparatory measures for reactor decommissioning and contaminated water", JFY2013.

flows out to the bypass area in the outer periphery of the core region, and damages the shroud when it makes contact. In the fifth path, the molten fuel further damages the jet pumps and relocates below to the lower core region.

To sum up, the following five relocation paths to below the core are considered from the relevant previous tests and the latest research.

- ① Inlet orifices of fuel supports (red)
- ② Control rod drive guide tube (CRGT) (blue)
- ③ Broken piping for core instrumentation lines (green)
- ④ Broken core plate (pink)
- ⑤ Broken shroud (violet)

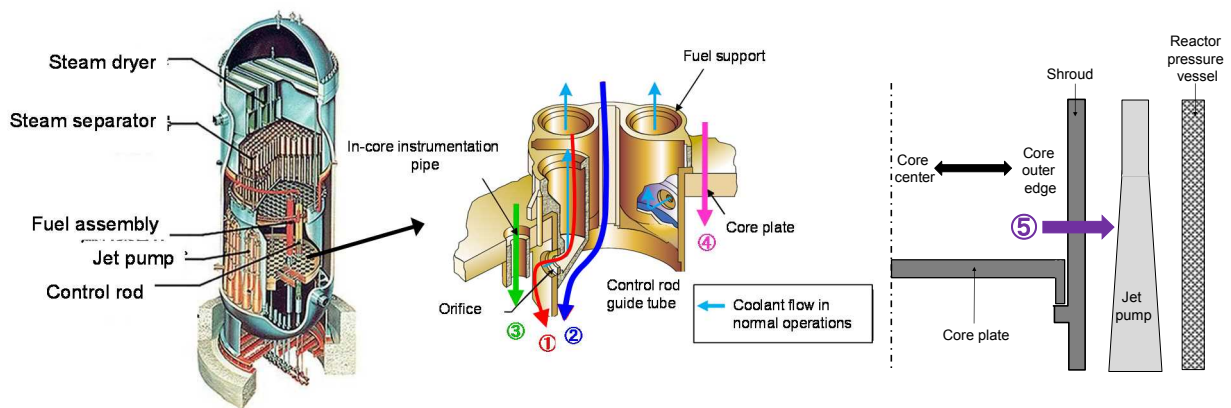

Figure 2.1 BWR lower core structures and molten fuel relocation paths considered in relevant previous tests [5, 6] and the latest research

3. Examination based on the relevant previous test results

Previous tests were surveyed in this section concerning the molten fuel relocation behavior from the core region to below the core in BRWs, and the probable paths were confirmed from among feasible relocation paths of molten fuel identified in Section 2. Based on the results, the relocation paths of molten objects at Unit-1 to Unit-3 of FDNPS have been estimated.

The following tests were surveyed.

- (i) Test XR2-1 [5] done at the US Sandia National Laboratory
- (ii) Control blade degradation tests done at the Japan Atomic Energy Agency [6, 7]

Item (ii) tests cover the research results obtained within the Project for Advancing Technological Bases for Safety Measures of Nuclear Power Generating Facilities, JFY2014,

directed by the Agency of Natural Resources and Energy of the Ministry of Economy, Trade and Industry.

3.1. Examination based on the test results of XR2-1 done at the Sandia National Laboratory

3.1.1. Outline of the test and the results

<Outline of the XR2-1 test>

Figure 3.1 illustrates the test facility. Part of four fuel assemblies and two control blades in the core region were simulated in the facility. Out of four test fuel assemblies, one simulated half of an actual fuel assembly (including 28 fuel rods), two simulated part of an actual fuel assembly (including 16 fuel rods) and the fourth test fuel assembly simulated part of the corner portion of an actual fuel assembly (including 4 fuel rods). Between the test fuel assemblies, there was a space for control blades and one test piece had 22 B₄C rods and the other had 3 B₄C rods. The lower core structures were composed of nose pieces, part of two fuel supports, the core plate and the control rod velocity limiters.

Figure 3.2 shows a schematic for the whole test facility to simulate molten fuel relocation behavior. The relocation behavior was simulated in the following way. A metal wire was inserted from above the top of core to below at a preset constant speed; the wire was melted by induction heating; and the molten object was dropped from the top of core into the core region. Two kinds of metal wire were prepared, one was the fuel cladding material Zr and the other was the control blade material steel/B₄C. These wires were arranged so that their molten objects would drop to the position in the core where such materials (Zr or steel/B₄C) were to be present.

In the tests, the isolation gate was closed first between the core region and the induction heating space, and then the metal wires were heated by induction heating to 2650K. Finally, by opening the isolation gate, only the steel/B₄C was dropped first and then only the Zr was dropped.

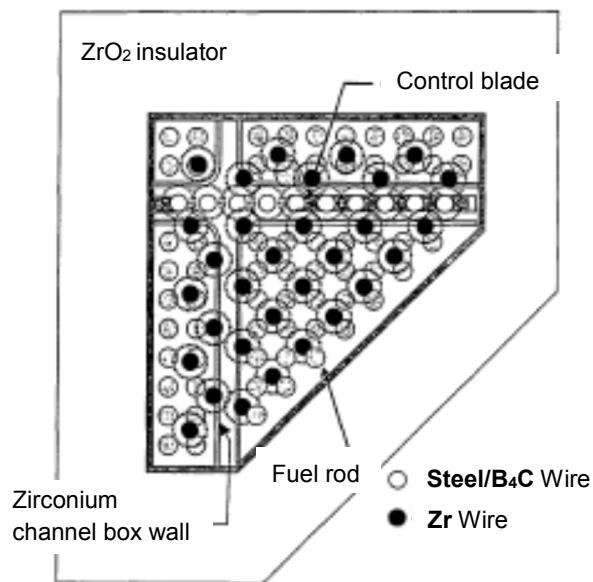
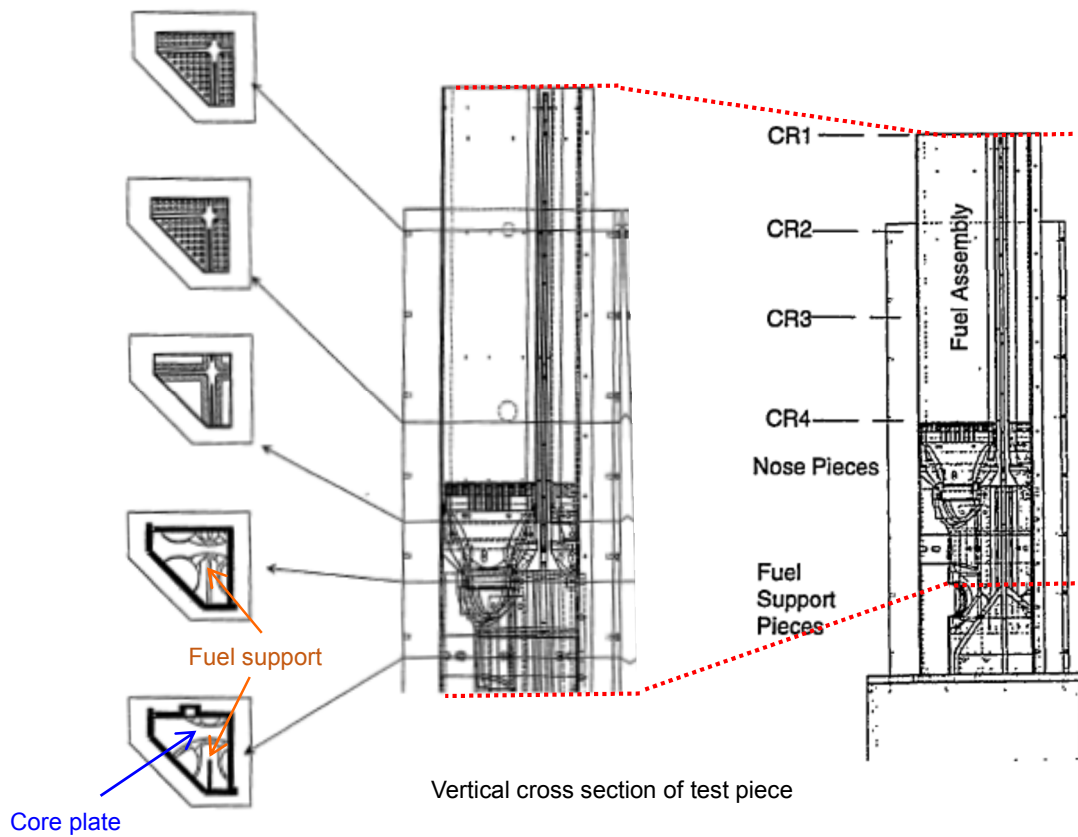

Figure 3.1 XR2-1 test facility [5]

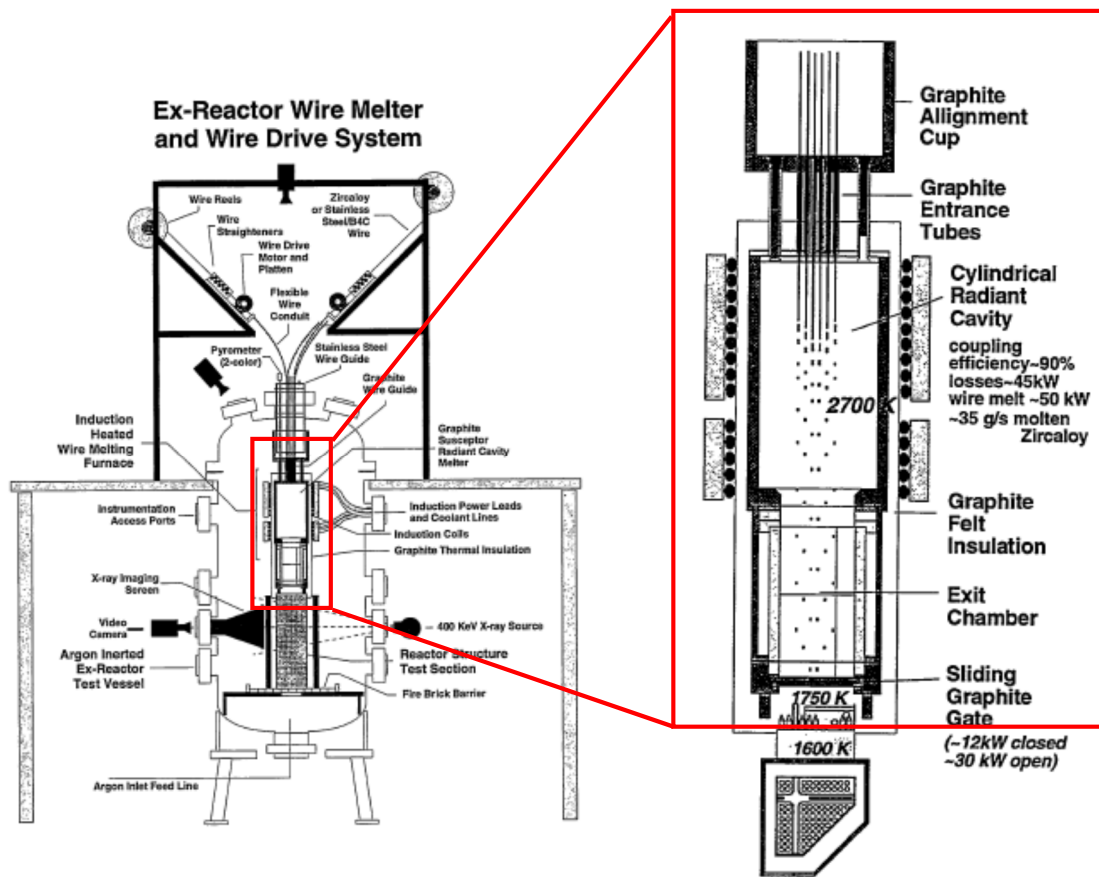

Figure 3.2 Schematic view of the test facility for simulating molten object relocation behavior

<Test results>

Figure 3.3 shows X-ray photos of the test section taken after the test and they show the molten objects in the test section. Structures were photographed in black. Most of the core region was photographed in white, indicating that most structures there had been melted and fallen down. The region below the core, on the other hand, was photographed in black, showing that the molten objects had solidified there. More of the solidified objects was located at the inlet nozzle and on the control rod velocity limiter than at other locations. The core plate was not broken in the test.

Table 3.1 presents the relocation results of molten objects after the test. About 81 % of the molten objects, i.e. the molten metal wires and the fuel and structures melted by them (molten

metal wires), relocated to below the core plate; the rest were left in the core region. Out of the relocated molten objects below the core plate, about 33 % flowed out to below the fuel supports (catcher box), 37 % were on the control rod velocity limiter and the rest, about 11 %, solidified at the inlet nozzle of the fuel supports. About 7 % of all the molten objects remained stacked on the core plate.

Table 3.1 Location and volumes of relocated molten objects [5]

Molten Material Identified at Post Test		Molten Material Available for Relocation During Test	
Location	Volume (liter)	Molten material available	Volume (liter)
Material found below the core plate	7.06	Introduced as wire feed	8.6
Catcher box	2.9	SS/B ₄ C composite wire	2.7
On velocity limiter	3.2	Zircaloy wire	5.9
Inlet nozzle	0.96	Test section structural material (excluding UO ₂)	1.5
Material above core plate	1.7	Active control blade	0.19
Above core plate	.62	Fuel rod cladding	1.0
In nosepieces	.77	Fuel canister walls	0.31
Control blade gap	.31		
Volume accounted for:	8.76	Total volume available:	8.6 - 10.1
Volume unaccounted for:	-0.16 + 1.34		

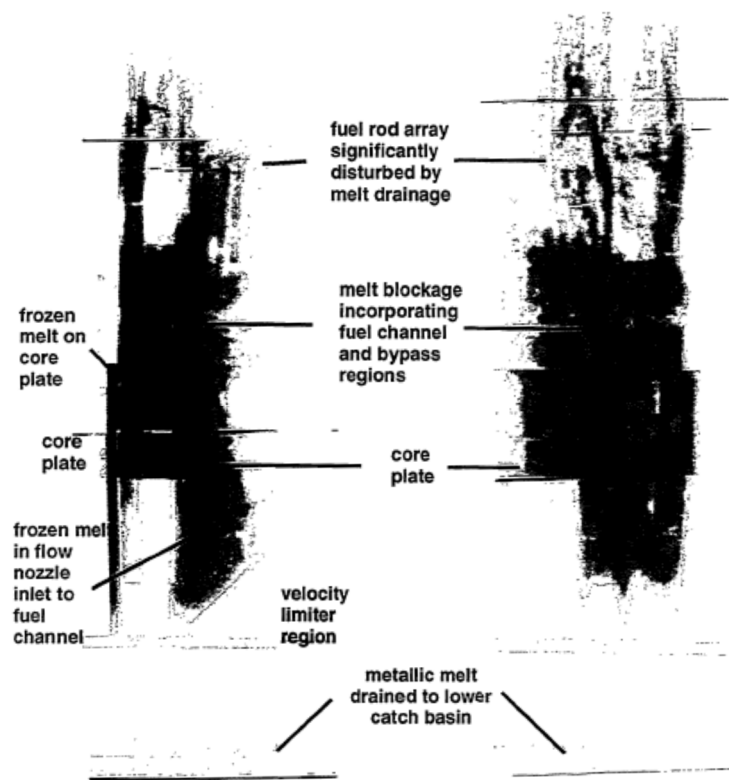

Figure 3.3 X-ray projections of test sections after tests [5]

3.1.2. Examination of relocation paths of molten objects based on the test results

From the test results described above, it is seen that, from among four feasible relocation paths from the core region to below the core mentioned in Section 2, the molten objects are more likely to take two paths: Path ① via inlet orifices of fuel supports and Path ② via CRGT. Concerning Path ④ via the broken core plate, the molten objects remained on the core plate in the test, but the core plate was not broken. It is still difficult to conclude that the core plate would not be broken in the actual system, because in the test molten objects consisting of metallic components of control blade materials, channel boxes and the like could have relocated, but the melting of core fuel at elevated temperatures and its relocation could not have been tested. If such molten fuel at elevated temperatures had fallen and accumulated on the core plate, the support plate would be susceptible to breaking. This indicates, therefore, there can be large uncertainties in molten fuel relocation behavior in the accident phase of high temperature core fuel melting.

3.2. Examination based on the results of the control blade degradation test done by the Japan Atomic Energy Agency

3.2.1. Outline of the test and the results

< Outline of the test >

Figure 3.4 shows the test piece used. It measured approximately 70mm x 70mm in width and 1,200mm in height, and was composed of a control blade and channel boxes. The control blade contained B₄C rods compacted to about 70% theoretical density (same level as the real one). Also for the channel boxes the actual Zircaloy-4 was used and for the fuel claddings the actual Zircaloy-2 was used. Furthermore, Inconel-made spacers were used to fix the fuel rods as in the actual system.

The test was conducted in an argon atmosphere with temperature as the parameter. The atmosphere was dry with no steam contents.

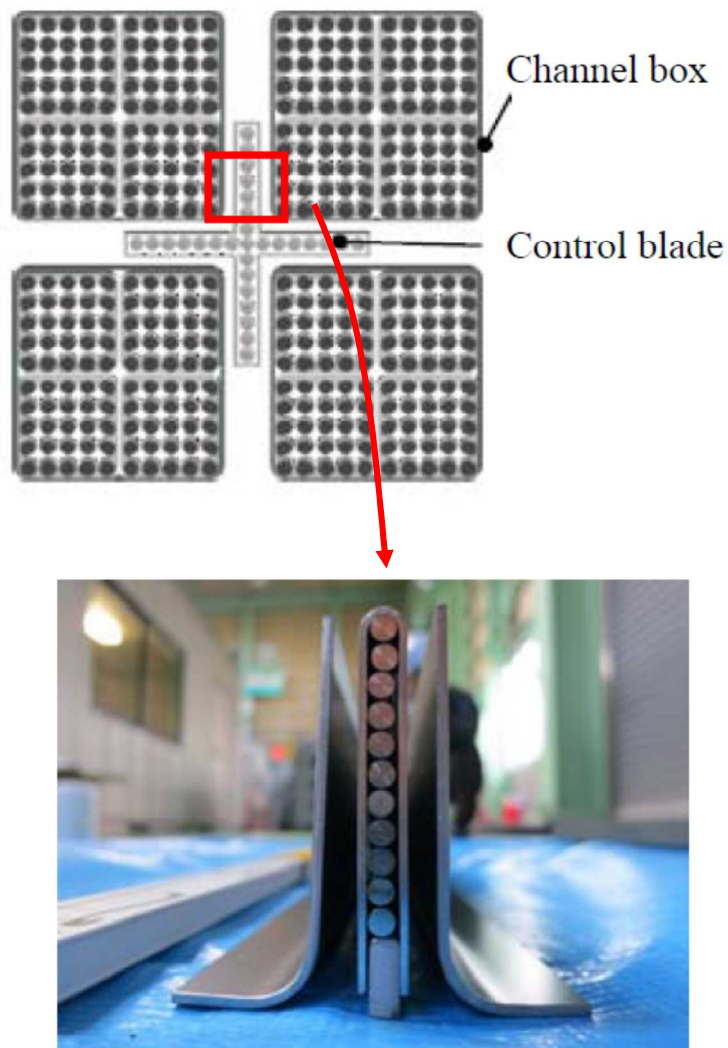

Figure 3.4 Test piece [6]

<Test results>

Figure 3.5 reproduces photos of the test piece after the test. The test confirmed that the molten reaction products of the control blade and channel boxes flowed down between them. It can be interpreted that Zr-Fe eutectic reactions occurred between SUS316L-made control blade sheaths and the Zircaloy-4 channel boxes when they physically contacted and the

molten reaction products flowed down. The test confirmed the molten reaction products flowed down to the bottom of the test piece.

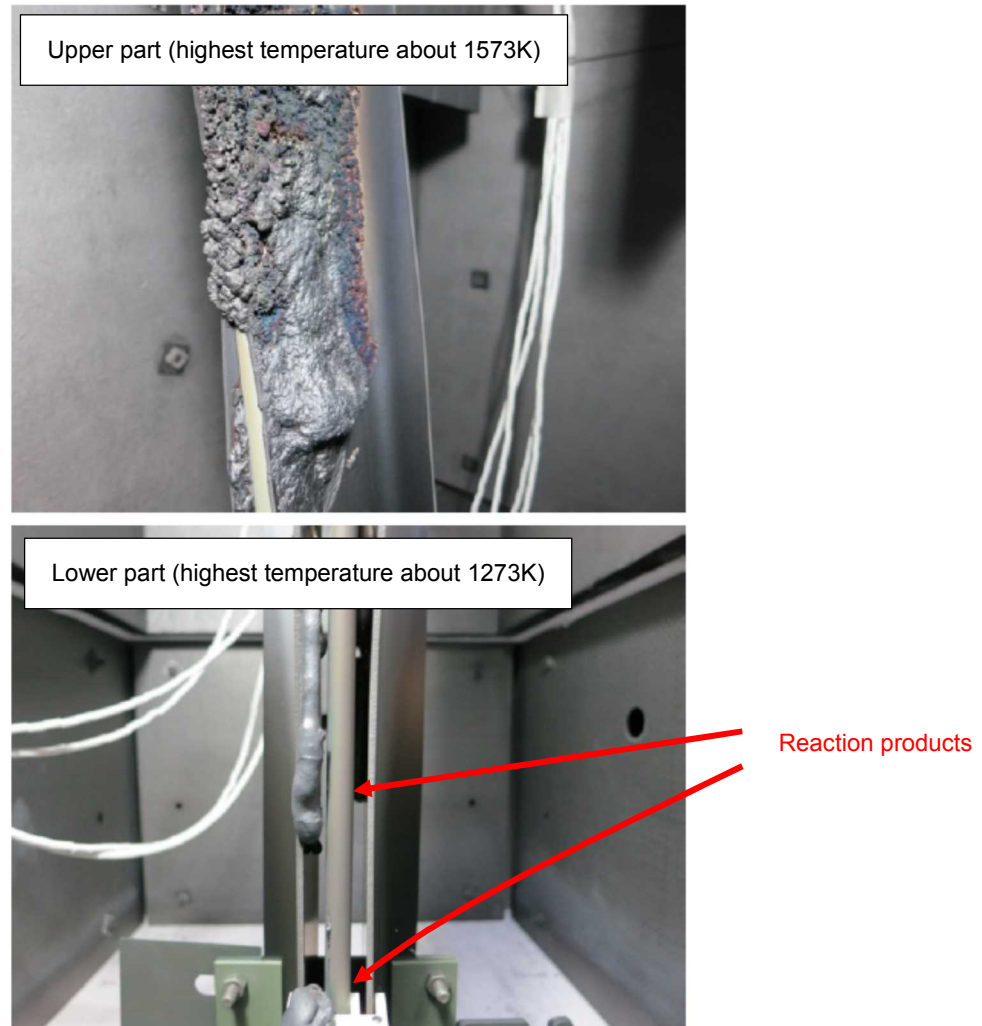

Figure 3.5 Photos of the test piece after the test [7]

3.2.2. Examination of transfer paths of molten objects based on the test results

The test results above indicate a good possibility that reaction products were formed between the control blade and channel boxes upon their mechanical contacts, and the molten objects of control blades themselves would drop right into the bottom along the gap (flow path) next to them in their normal arrangement. That means the reaction products would likely flow down directly to the CRGT. But if the reaction products blocked the flow path by

solidifying while they were flowing down, the reaction products flowing down from the upper part of the core would likely flow into the radial direction. As a matter of fact, some test XR2-1 results showed signs that a meaningful amount of molten objects had flowed out to the Path ①, inlet orifices of fuel supports mentioned in Section 2.

From the deliberations above among the feasible relocation paths mentioned in Section 2, reaction products formed between the control blade and channel boxes upon their mechanical contacts, and the molten objects of control blades themselves can be considered to go through mainly Path ②, via CRGT and Path ①, via inlet orifices of fuel supports.

4. Examination based on the results obtained by the latest severe accident analysis codes

This section examined the molten fuel relocation behavior to below the core at Unit-1 to Unit -3 of the FDNPS, based on the results of accident progression analysis at each unit using the latest analysis codes. Here, the results of accident progression analysis using the latest analysis codes refer to the results obtained in the program “Investigation of in-reactor conditions by the use of severe accident analysis codes,” undertaken under the “Preparatory measures for reactor decommissioning and contaminated water,” sponsored by the Agency of Natural Resources and Energy of the Ministry of Economy, Trade and Industry in JFY2013. The following analysis codes were used in the project.

- (i) MAAP: Version 5.03 (hereafter MAAP5.03)
- (ii) SIMPSON: Version 1.4.3 (hereafter SIMPSON1.4.3)

The results are given below in detail.

4.1. Analysis by MAAP5.03

The MAAP5.03 has been upgraded to take multiple relocation paths of molten fuel and the thermal interactions of molten fuel with reactor structures during relocation into consideration; these were not considered in the conventional version of MAAP. All five feasible relocation paths mentioned in Section 2 can be considered in MAAP5.03. MAP5.03 also considers that molten fuel may solidify during relocation by losing heat through thermal interactions with the structures and the solidified fuel may block the flow paths. The analysis results of molten fuel relocation behavior are outlined below for each reactor unit.

4.1.1. Analysis results

The analysis results of damaged core conditions are given for Unit-1 to Unit-3 in Figure 4.1 to Figure 4.3. The following points are observed to be in common at all units in the early stage of core damage as given by the MAAP5.03 accident progression results of each unit.

<Accident progression in common at all units>

At first, molten fuel relocated downward. The molten fuel formed a crust thereafter and blocked the relocation path in the areas of fuel assemblies below the bottom of active fuel (BAF) with no heat generation. Due to this relocation path blockage, a molten fuel pool was formed in the core region.

Molten fuel flowing through the in-core instrumentation pipes was evaluated to have solidified in the penetrations because the tubes were of small diameter. At the early stage of accident progression, some molten objects (control blades and channel boxes) relocated into the CRGT. But the pathway space between the fuel supports and the control rod velocity limiters was narrow and the molten fuel was evaluated as likely to have solidified inside the space, because the heat capacity of the fuel supports was relatively larger than the heat input by the molten fuel. There was a possibility that fresh molten fuel would melt the solidified objects when it flowed in.

After the shared accident progression above, each unit followed different progressions. They are outlined below.

<Unit-1>

After the molten fuel pool was formed, the shroud was damaged. Further, molten fuel relocated to below the core upon the central part of core plate being damaged. Afterward, the molten fuel left in the peripheral area of the core relocated to the paths via the inlet orifice of the fuel supports and control rod velocity limiters. Eventually, the whole core plate was degraded and no more molten fuel was left in the core region.

<Unit-2>

After the molten fuel pool was formed, molten fuel flowed out to below the core via the inlets to fuel assemblies. Molten fuel also relocated to the path via the control rod velocity limiters. The shroud damage seen in Unit-1 did not occur and the core plate had no degradation. The molten fuel was left in crust forms on the lower fuel tie plates, core plate, fuel supports and other parts of the lower core structure.

<Unit-3>

After the molten fuel pool was formed, molten fuel flowed out to below the core via the inlets to fuel assemblies in the central area of the core. The molten fuel that flowed out to below the core melted CRGT and control rod drive housings, damaging the core plate positioned above them and destroying its core support functions. The molten fuel and other molten objects accumulated on the central area of the core plate fell down step by step to

below the core. Eventually, no more molten fuel was left in the core region. The shroud was not damaged.

4.1.2. Examination of transfer paths of molten fuel based on the analysis results

Based on the results of the MAAP5.03 analysis concerning the accident progression of each unit, the molten fuel relocation paths mentioned in Section 2 can be summarized as Table 4.1.

Table 4.1 Summary of the MAAP5.03 analysis results for the relocation paths in Unit-1 to Unit-3

Relocation path of molten fuel from core region to below the core	Unit-1	Unit-2	Unit-3
① Inlet orifices of fuel supports	○	○	○
② CRGT ^(a)	○	○	○
③ Broken piping of core instrumentation lines	×	×	×
④ Broken core plate	○	×	○
⑤ Broken shroud	○	×	×

○: Molten fuel flowed via this path;

×: Molten fuel did not flow via this path;

---: Not assumed as a relocation path

^(a): Molten objects were evaluated as having solidified at an early stage of accident progression on the control rod velocity limiters. There was a possibility that the solidified objects were melted by fresh molten fuel when it flowed in.

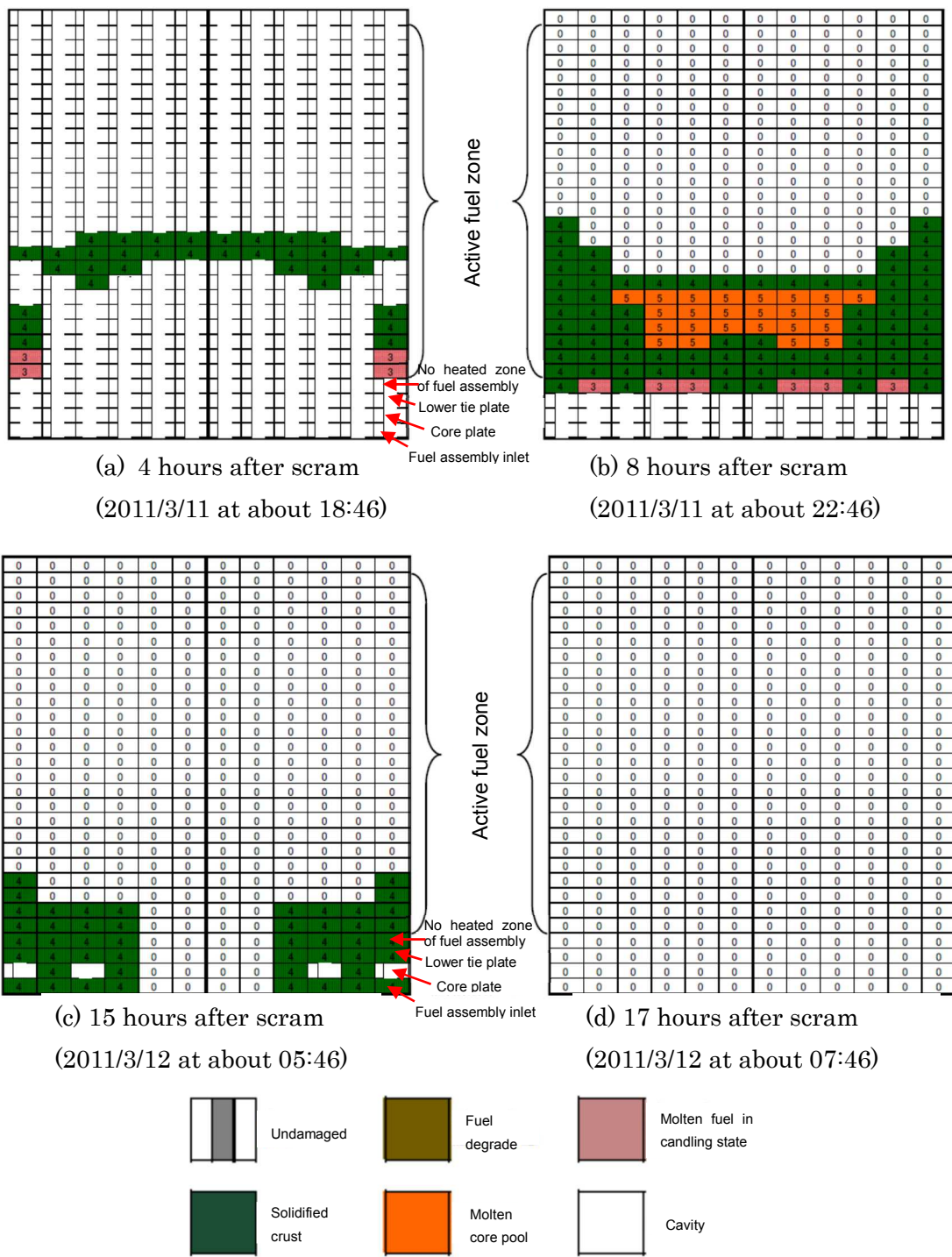

Figure 4.1 Conditions of damaged core (Unit-1)

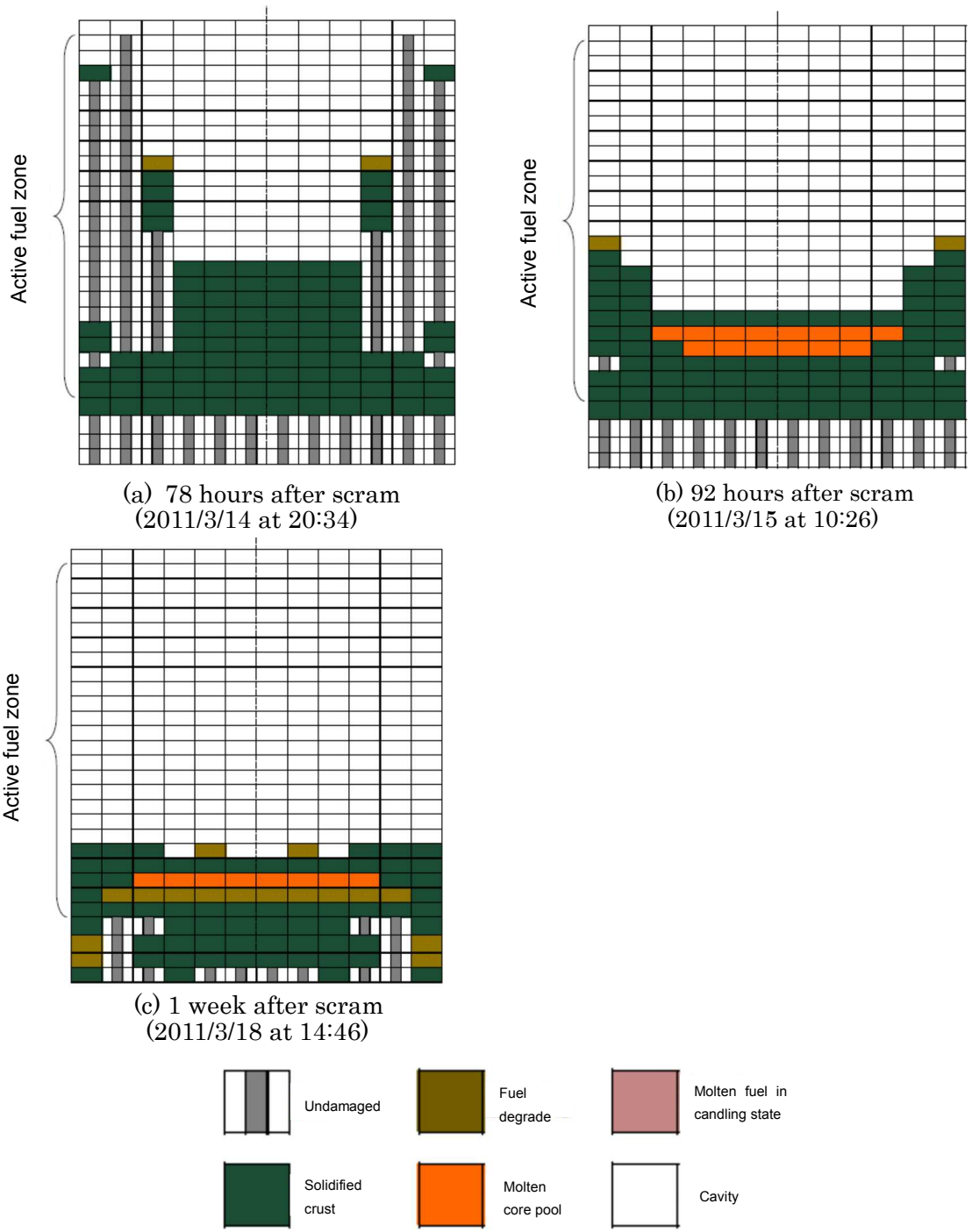

Figure 4.2 Conditions of damaged core (Unit-2)

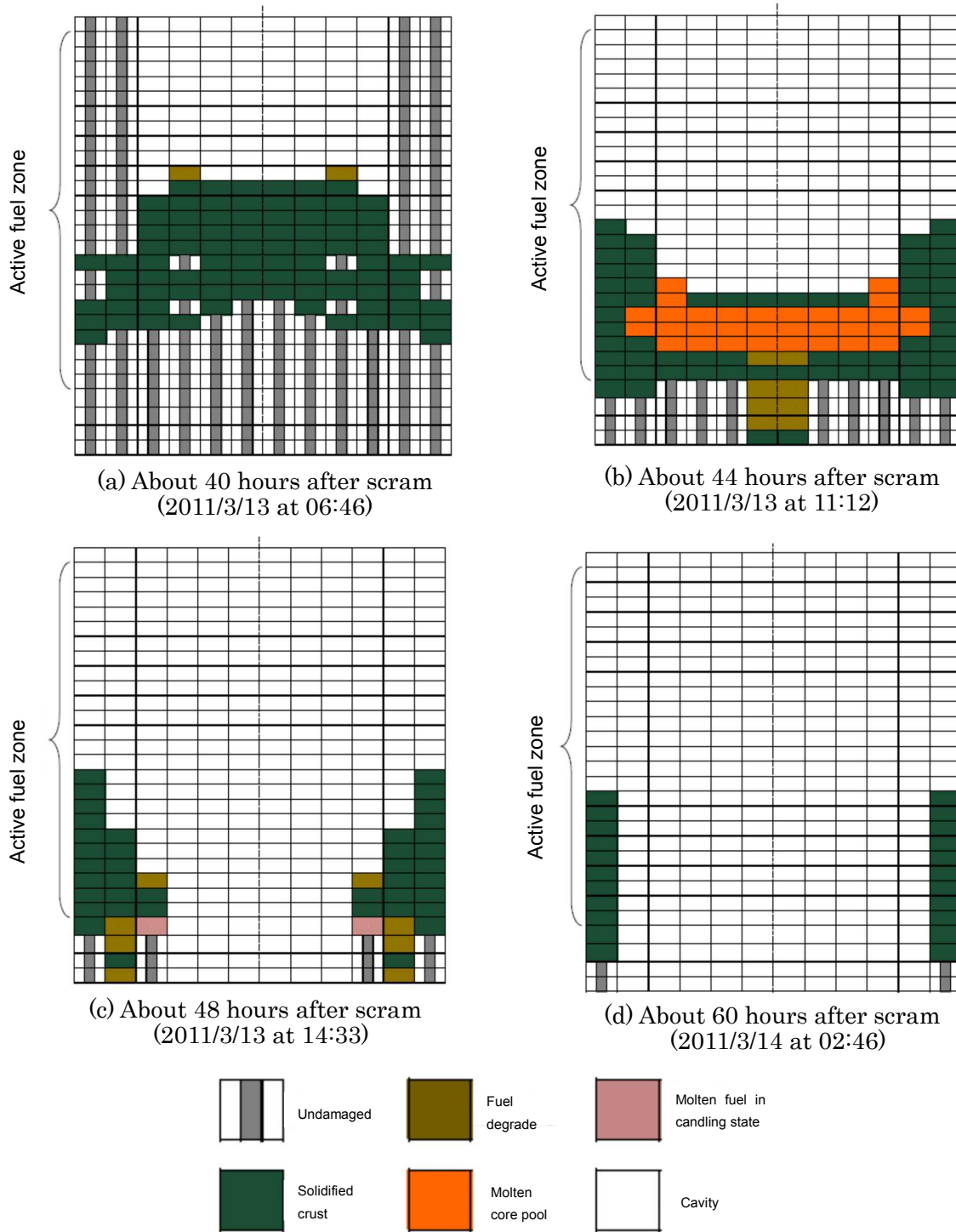

Figure 4.3 Conditions of damaged core (Unit-3)

4.2. Analysis by SAMPSON1.4.3

SAMPSON1.4.3 has been upgraded to divide the region into sub-regions for analysis in order to take into consideration the actual structures of multiple relocation paths of molten fuel; these were not considered in the conventional version of SAMPSON. It was also assumed that all fuel rods above the core plate dropped below once the core plate is melted. As the relocation paths, three Paths ① to ③ mentioned in Section 2 are considered. Concerning Path ④ via the damaged core plate, the volume and material properties of the core plate were considered in the analysis cells, but molten fuel was not assumed to be accumulated on the plate. Concerning Path ⑤ via the damaged shroud, no molten fuel relocation was considered (the shroud damage itself was considered, but no fuel relocation through the damaged portion was considered in the model of analysis.). Thermal interactions of molten fuel with the surrounding structures and the consequent flow path blockage due to heat loss of molten fuel were considered in SAMPSON1.4.3 as in MAP5.03. The molten fuel relocation behavior from the core region to below the core is summarized below based on the analysis results of accident progression at each unit.

It should be noted that the analysis of Unit-3 used actually the version SAMPSON1.3.1, but it was confirmed that analysis results of molten fuel relocation paths did not differ from those of SAMPSON1.4.3.

4.2.1. Analysis results

The analysis results of damaged core conditions are given for Unit-1 to Unit-3 in Figure 4.4 to Figure 4.6. The following points are observed to be in common at all units in the early stage of core damage from the SAMPSON results of accident progression of each unit.

<Accident progression in common at all units>

The molten fuel reformed to crust, but did not block the relocation paths and most of the molten fuel relocated to the inlet orifices of the fuel assemblies or the CRGT.

Each unit followed the accident progressions as below thereafter.

<Unit-1>

The core plate was melted when it contacted with part of the molten fuel and all structures in the core region dropped to below the core. The molten fuel which relocated to the CRGT melted the control rod velocity limiters. Eventually, no molten fuel was left in the core region. The lower part of the shroud was also melted.

<Unit-2>

The core plate and control rod velocity limiters were not completely damaged by the molten fuel. Molten fuel was left in crust forms on the lower structures such as the lower fuel tie-plates, core plate and fuel supports. Part of the upper shroud was damaged.

<Unit-3>

The core plate was melted when it contacted with part of the molten fuel and all structures in the core region dropped to below the core. The molten fuel which relocated to the CRGT melted the control rod velocity limiters. Eventually, almost no molten fuel was left in the core region. The lower part of the shroud was also melted.

4.2.2. Examination of transfer paths of molten fuel based on the analysis results

Based on the analysis results obtained by SAMPSON1.4.3 (SAMPSON1.3.1 for Unit-3) concerning the accident progression of each unit, molten fuel relocation paths mentioned in Section 2 can be summarized as Table 4.2.

Table 4.2 Summary of the SAMPSON analysis results for the relocation paths in Unit-1 to Unit-3

Relocation path of molten fuel from core region to below the core	Unit-1	Unit-2	Unit-3
① Inlet orifices of fuel supports	○	○	○
② CRGT	○ ^(a)	○	○ ^(a)
③ Broken piping of core instrumentation lines	---	---	---
④ Broken core plate ^(b)	○	×	○
⑤ Broken shroud ^(c)	○	×	×

○: Molten fuel flowed via this path;

×: Molten fuel did not flow via this path;

---: Not assumed as a relocation path

^(a): Control rod velocity limiters were evaluated as having melted.

^(b): Molten fuel was not assumed to accumulate on the core plate.

^(c): Damage was considered for the shroud, but molten fuel relocation through the damaged portion was not considered. The mark ○ was obtained from the evaluation of possibility of fuel flowing out.

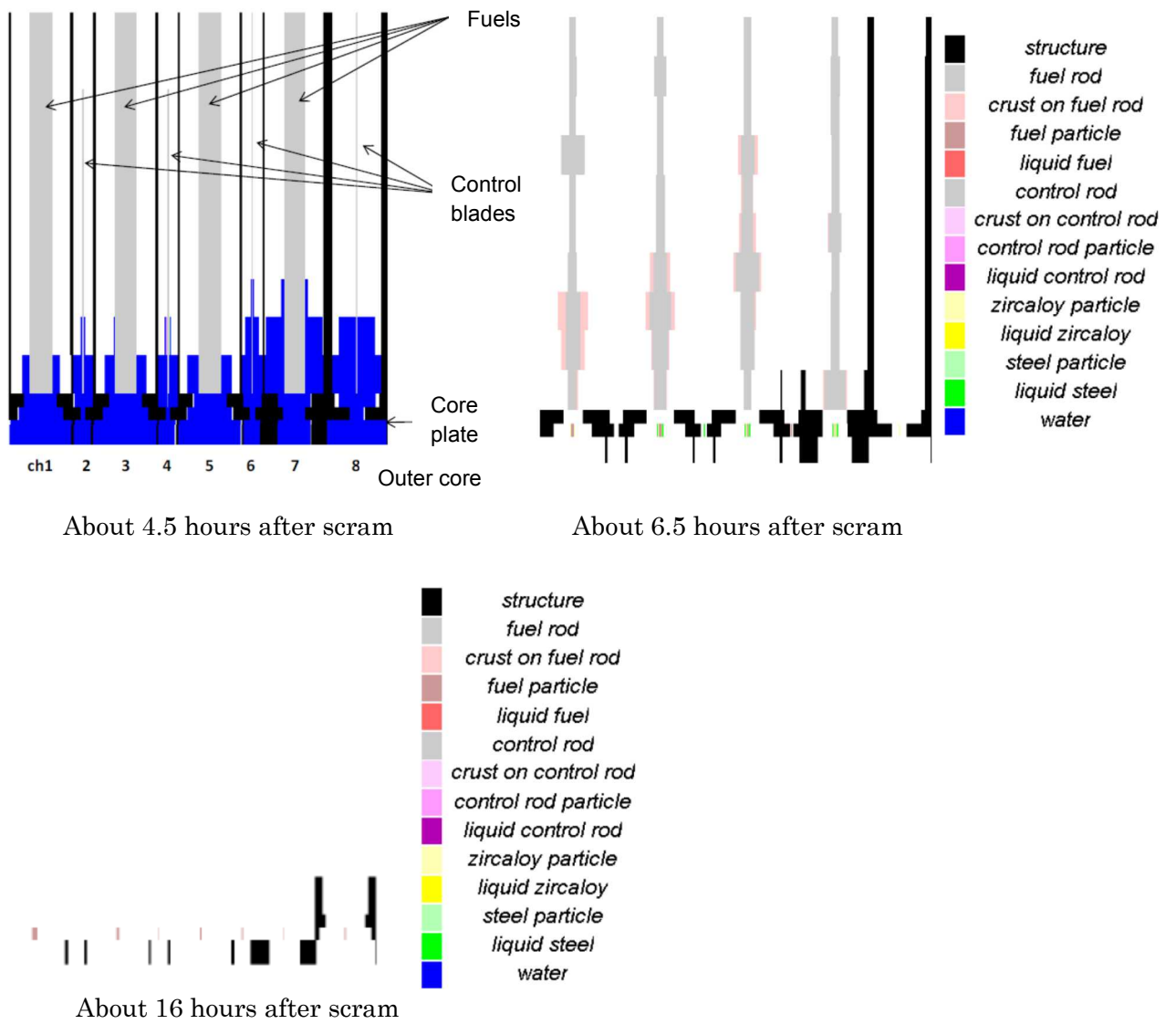

Figure 4.4 Conditions of damaged core of Unit-1 (Volume fractions)

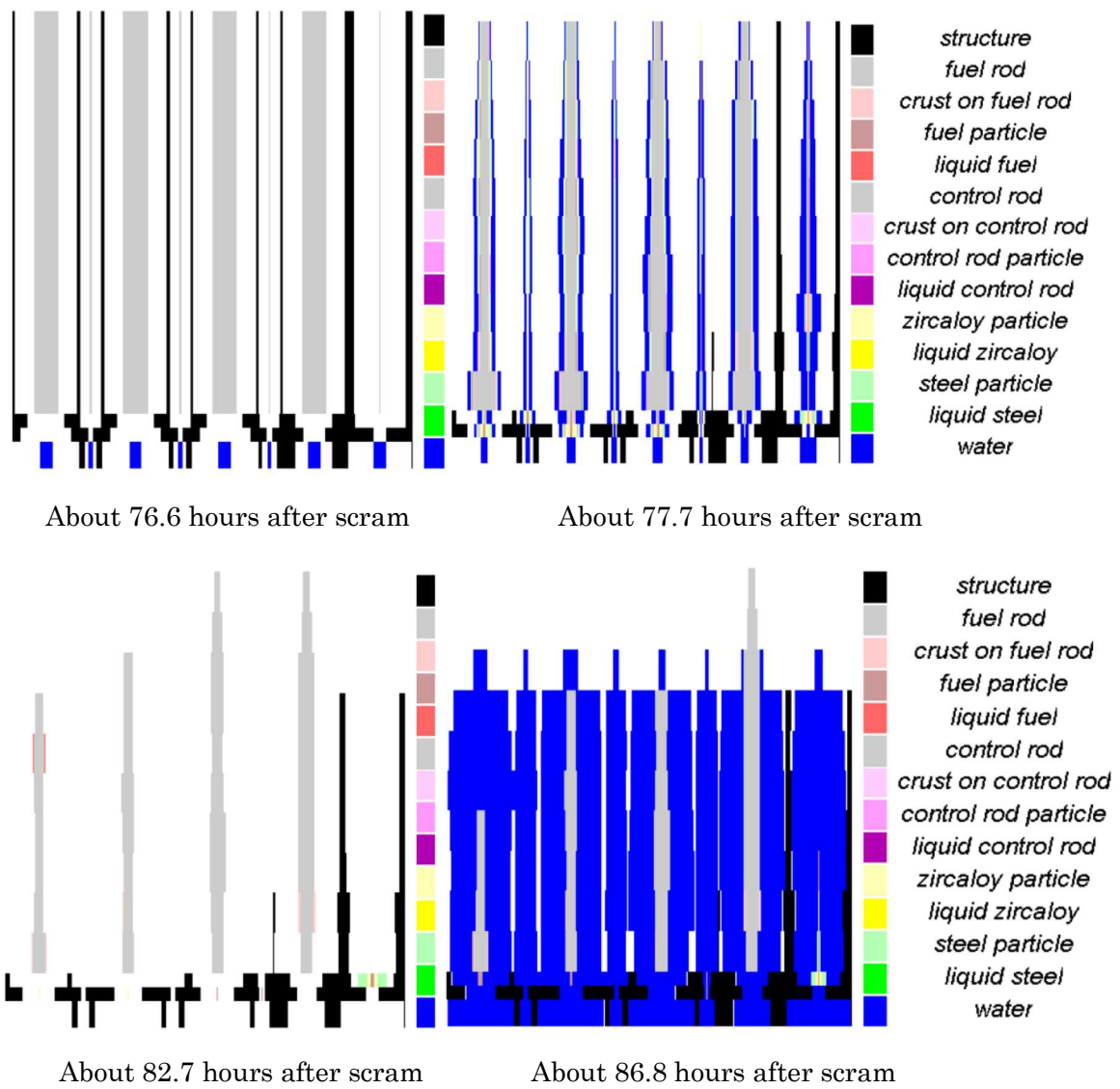

Figure 4.5 Conditions of damaged core of Unit-2 (Volume fractions)

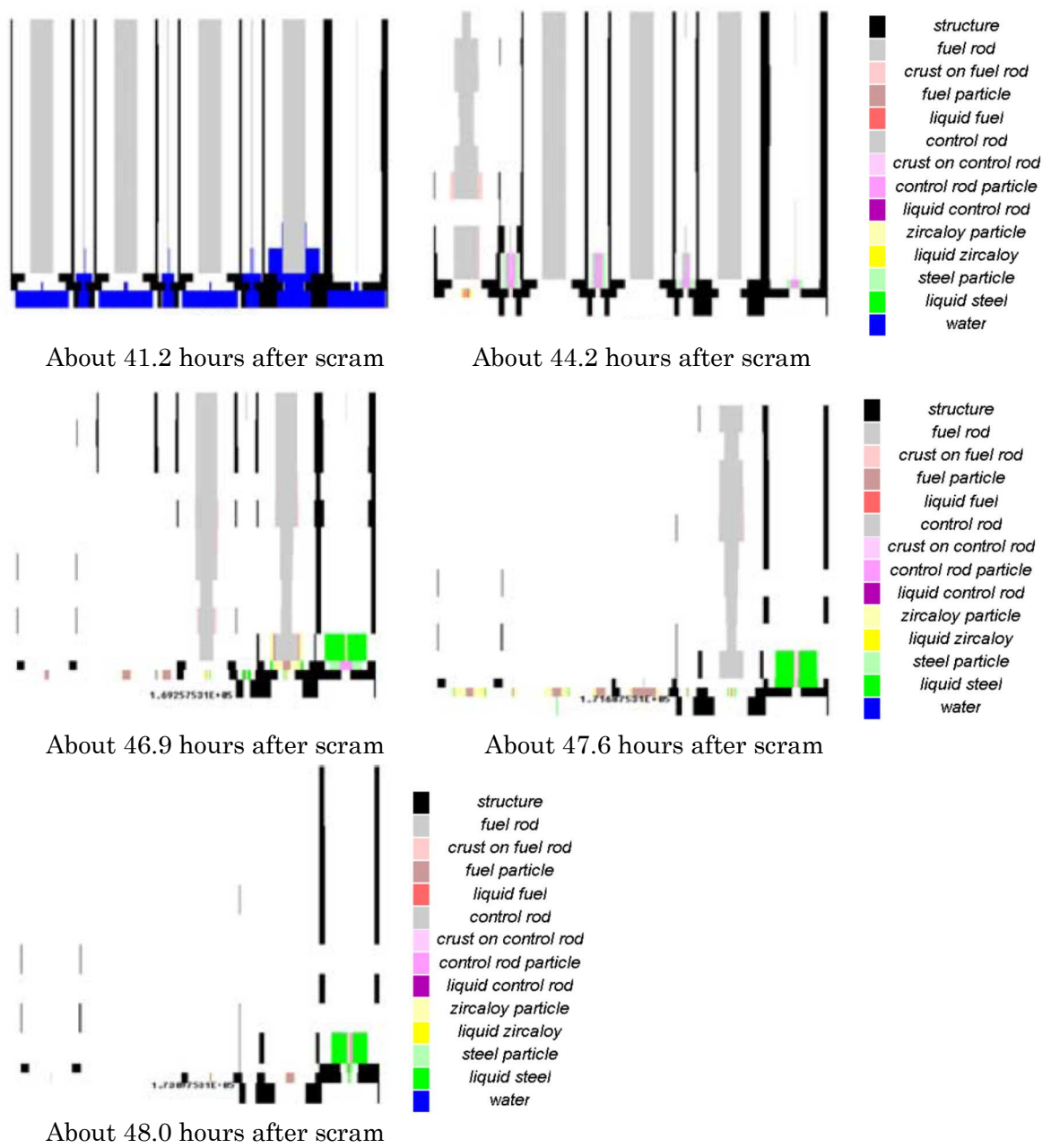

Figure 4.6 Conditions of damaged core of Unit-3 (Volume fractions)

5. Estimation of relocation behavior of molten fuel to below the core in the accident at the FDNPS

Molten fuel relocation paths have been examined in preceding sections based on the results of tests given in the literature and analysis codes. Those results are summarized in Table 5.1 for each relocation path of ① to ⑤ described in Section 2. The estimation results are also presented below concerning the relocation behavior of molten fuel to below the core in Unit-1 to Unit-3 in the accident at the FDNPS.

① Relocation of molten fuel via the inlet orifices of fuel supports.

At all three units, the molten fuel is estimated to have relocated to below the core via this path in the accident.

② Relocation of molten fuel via the CRGT

At all three units, the molten fuel and molten objects (control blades and channel boxes) are estimated to have relocated to the top of the control rod velocity limiters via this path in the accident. In the early stage of the accident, the molten objects relocated first to the top of the control rod velocity limiters. The molten fuel is likely to have solidified in the space between the area enclosed by the inlet orifices to the core and the control rod velocity limiters, because the space was narrow, the heat capacity of fuel supports was relatively larger than the heat input by the molten fuel and there was a possible existence of coolant in the CRGT. There is a possibility that the fresh molten fuel melted the solidified objects when it flowed in.

③ Relocation of molten fuel via the damaged in-core instrumentation pipes

It is highly probable the molten fuel solidified in the in-core instrumentation pipes, because they were of small diameter. Therefore, it is estimated that the molten fuel did not relocate to below the core via this path.

④ Relocation of molten fuel via the damaged core plate

In the analyses, the molten fuel relocated to below the core as a result of the core plate melting and degrading. But in the tests, damage to the core plate was not confirmed.

The core plate damage depends on the amount of molten fuel accumulated on it and further the amount of accumulated molten fuel depends on the flow path blockage due to frozen crust. The amount of accumulated molten fuel on the core plate estimated by analysis has large uncertainties, while in the tests the simulation of the real system might have been insufficient: although the geometry was simulated, the core region simulated was limited and the temperature conditions were different from the real system.

Consequently, at Unit-1 to Unit-3 the molten fuel might have relocated to below the core in the accident via this path, but it is not possible to conclude that now because of the large uncertainties.

⑤ Relocation of molten fuel via the damaged shroud

Two different severe accident analysis codes gave the results independently that the lower part of shroud had been damaged at Unit-1 and Unit-3. Therefore, it is possible that the molten fuel relocated at Unit-1 and Unit-3 via this path to below the core, but again as in ④ above it is too early to conclude this because of the large uncertainties.

Concerning Unit-2, it is estimated that the molten fuel did not relocate via the path through the damaged shroud on the following grounds. It was understood in the “Report on the responses to temperature increases at the bottom of reactor pressure vessel of Unit-2 of the Fukushima Daiichi NPS”[8] that “coolant water, being considered to exist around the subject area of concern from the relationship between the inlet pressures of the reactor recirculation system and the amount of water injection from the feedwater system, cools the subject area and overall the reactor is considered to have been cooled”. The shroud of Unit-2 was not significantly damaged.

Table 5.1 Survey results of molten fuel relocation paths to below the core in (A) previous relevant tests and (B) the latest research for upgrading analysis codes

Molten fuel relocation path from the core region to below the core	Tests		Analysis					
	(A) XR2-1 (SNL)	(B) Control blade degradation tests (JAEA)	(B) MAAP5.03 analysis of actual system			(B) SAMPSON1.4.3 analysis of actual system (SAMPSON1.3.1 for Unit-3)		
			Unit-1	Unit-2	Unit-3	Unit-1	Unit-2	Unit-3
(i) Inlet orifice of fuel supports	○	—	○	○	○	○	○	○
(ii) CRGT	○	○ ^(a)	○ ^(b)	○ ^(b)	○ ^(b)	○ ^(c)	○	○ ^(c)
(iii) Damaged in-core instrumentation pipes	—	—	×	×	×	—	—	—
(iv) Damaged core plate	×	—	○	×	○	○ ^(d)	×	○ ^(d)
(v) Damaged shroud	—	—	○	×	×	○ ^(e)	×	○ ^(e)

○: Molten fuel flowed via this path; ×: Molten fuel did not flow via this path; ---: Not assumed as a relocation path

- (a): Evaluated as ○ because the molten fuel was likely to relocate directly to the CRGT based on the test results.
- (b): Molten objects in the early stage of accident progression were evaluated to solidify on the top of the control rod velocity limiters.
- (c): Control rod velocity limiters were evaluated to have melted.
- (d): No accumulation of molten fuel on the core plate was considered.
- (e): The shroud was damaged, but molten fuel relocation through the damaged portion was not considered in the analysis. The evaluation was judged from the evaluation of possibilities of fuel flowing out.

6. Summary

The molten fuel relocation paths from the core region to below the core have been examined based on the knowledge obtained from the survey of the relevant previous tests and the latest research results on analysis codes. The results are summarized below.

- At all Units-1 to 3, the molten fuel was estimated to have relocated via the inlet orifice of the fuel supports and the CRGT. The molten fuel relocation path via the CRGT was likely to have had solidification in the gap space between the fuel inlet orifices and the control rod velocity limiters.
- At all Units-1 to 3, the molten fuel via in-core instrumentation pipes was estimated to have solidified in the penetrations, because the tubes were small in diameter.
- At all Units-1 to 3, the molten fuel might have relocated in the wake of core plate damage, but this relocation depends on the solidification and accumulation of molten fuel around the lower core structures and has big uncertainties in its behavior. As a result, it is not clear whether the molten fuel really relocated via this path.
- At Unit-1 and Unit-3 molten fuel might have relocated to below the core via the damaged shroud. But this relocation depends on the accumulation and solidification of molten fuel and has big uncertainties in its behavior. It is not possible to conclude now whether the molten fuel actually relocated via this path. Concerning Unit-2, coolant water could be considered to have existed around the shroud area from the relationship between the inlet pressures of reactor recirculation system and the amount of water injected. The shroud was estimated not to have been damaged significantly.

A survey of relevant information from the actual plants and in the national and international projects below will be continued in order to mitigate the uncertainties mentioned above.

- National projects

The project “Upgrading of analytical methods for fuel damage and melting process under severe accidents” is being undertaken as part of the national project on the infrastructure development for strengthening safety measures. In this particular upgrading project, molten fuel relocation tests are now in progress using fuel assemblies and control blades simulating those in the actual plant. Tests in steam atmosphere are foreseen.

Meanwhile, a three-dimensional code for detailed analysis of molten fuel relocation know as JUPITER (JAEA Utility Program with Immersed boundary Technique and Equations of multiphase flow analysis for simulating Relocation behavior of molten debris) is being developed based on a numerical thermo-hydraulic approach to simulate the system and

will be used in analyzing the molten fuel relocation behavior from the core region to below the core [9].

- International projects

An international project “Benchmark Study of the Accident at the Fukushima Daiichi Nuclear Power Station (BSAF)” is being undertaken at the Organization for Economic Cooperation and Development/Nuclear Energy Agency (OECD/NEA). In this project, nuclear reactor severe accident analysis codes world-wide are being used to analyze the accident progression at Unit-1 to 3 of the Fukushima Daiichi Nuclear Power Station [10].

References

- [1] Nuclear Safety Research Association, Overview of Light Water Nuclear Power Stations, September 2008 (English version April 2010)
- [2] TEPCO, Progress Report No. 1, Evaluation of the situation of cores and containment vessels of Fukushima Daiichi Nuclear Power Station Unit-1 to Unit-3 and examination into unsolved issues in the accident progression, December 13, 2013 (English version http://www.tepco.co.jp/en/press/corp-com/release/2013/1233101_5130.html)
- [3] TEPCO, Progress Report No. 2, Evaluation of the situation of cores and containment vessels of Fukushima Daiichi Nuclear Power Station Units-1 to 3 and examination into unsolved issues in the accident progression, August 6, 2014 (English version http://www.tepco.co.jp/en/press/corp-com/release/2014/1240140_5892.html)
- [4] TEPCO, Progress Report No. 3, Evaluation of the situation of cores and containment vessels of Fukushima Daiichi Nuclear Power Station Units-1 to 3 and examination into unsolved issues in the accident progression, May 20, 2015 (English version http://www.tepco.co.jp/en/press/corp-com/release/2015/1250927_6844.html)
- [5] R.O. Gauntt, L.L. Humphries, “Final Result of the XR2-1 BWR Metallic Melt Relocation Experiment”, NUREG/CR-6527 SAND97-1039, 1997
- [6] “Experimental Study on Control Blade Degradation and Its Modeling”, Proceedings of WRFPM, Paper No. 100079, Sendai, Japan, Sept. 14-17, 2014
- [7] Advancement of fuel damage/melt process analysis method under severe accident conditions – Project outline and current status, Nuclear Fuel Session, “Basic research on severe accident at, and decommissioning of, Fukushima Daiichi Nuclear Power Station”, Autumn Meeting of the Atomic Energy Society of Japan September 8 – 10, 2014, Kyoto University
- [8] Report on the responses to temperature increases at the bottom of reactor pressure vessel of Unit-2 of the Fukushima Daiichi NPS, February 15, 2012 (<http://www.meti.go.jp/press/2011/02/20120216002/20120216002.html>)

- [9] S. Yamashita, Simulation of Molten Fuel Relocation, 26th Workshop, Center for Computational Science and e-Systems (CCSE), February 26, 2015
- [10] “Information Portal for the Fukushima Daiichi Accident Analysis and Decommissioning Activities”, URL: <http://fdada.info/index>