

## Examination into water injection by fire engines

### 1. Introduction

Units-1 to 3 at the Fukushima Daiichi Nuclear Power Station lost all their water injection functions, which would have been relied upon in an accident, and as an emergency means, alternative water injection to the reactors was implemented using fire engines. However, there was a possibility that part of the water injected by fire engines was not sent to the reactor but went to other systems and equipment. This became known by confirming bypass lines in the piping & instrumentation drawings or accumulated water in the main condenser.

This document presents an overview of alternative water injection measures and summarizes possible bypass lines for the water injection lines, as a preparatory step to determine the actual amount of water injected to the reactors by fire engines. In addition, also included are the results of reviewing the injection flow rate in more detail than the daily average amount, which has been made public. This was obtained based on the newly known chronological information and relevant plant data. Further, the measures being taken at the Kashiwazaki-Kariwa Nuclear Power Station based on this experience at the Fukushima Daiichi Nuclear Power Station are also presented herein.

### 2. Alternative water injection to the reactor by fire engines

In the early stage of water injection by fire engines, they were connected to the fire protection system and then to the make-up water condensate (MUWC) system, from where water was sent through the core spray (CS) system (Unit-1) or the residual heat removal (LPCI lines of the RHR system) (Unit-2 and Unit-3) to the reactor (Figure 1).

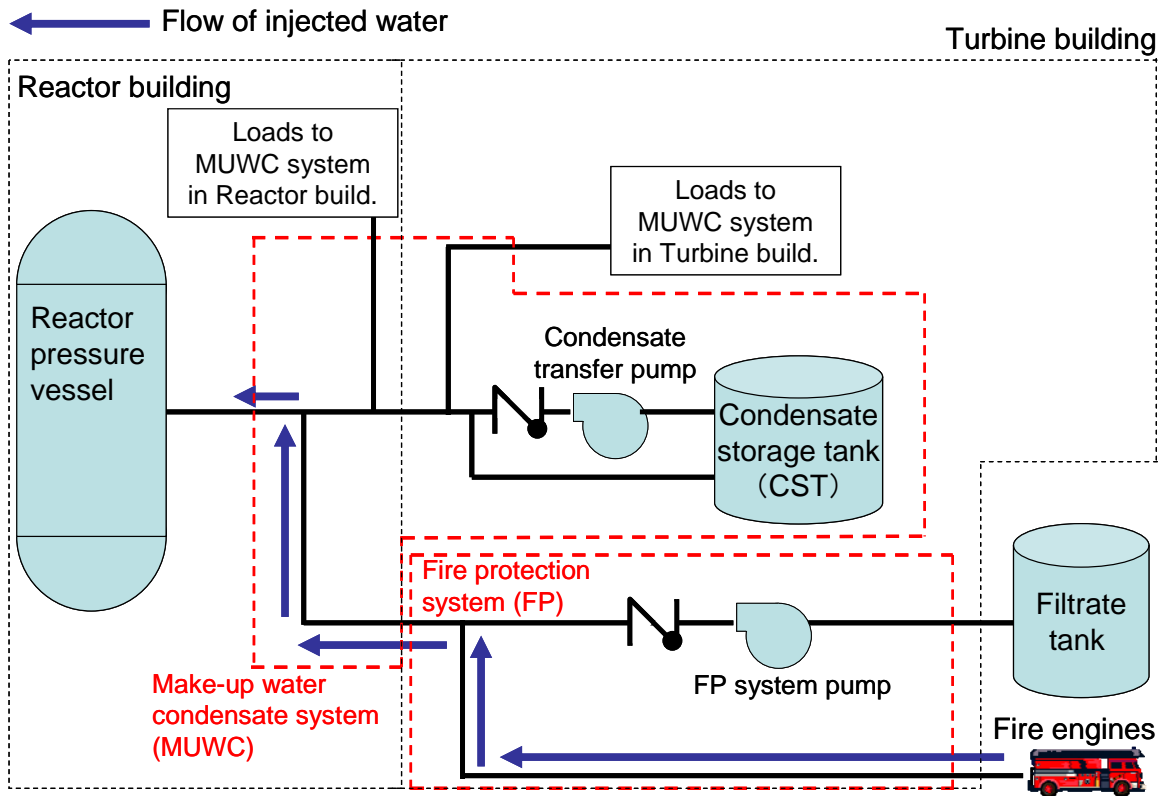

Figure 1 Line configurations for alternative water injection by fire engines

Figures 2 to 4 show the daily average amounts of water injected at the discharge point of the fire engine pumps, which are data that have been made open. These daily average values are different from actual injected values, because their flow rate is roughly estimated using measured values of a discharge pressure gage or discharge flow rate meter of fire engines and they are averaged over a day and include some estimated values when no measured values are available.

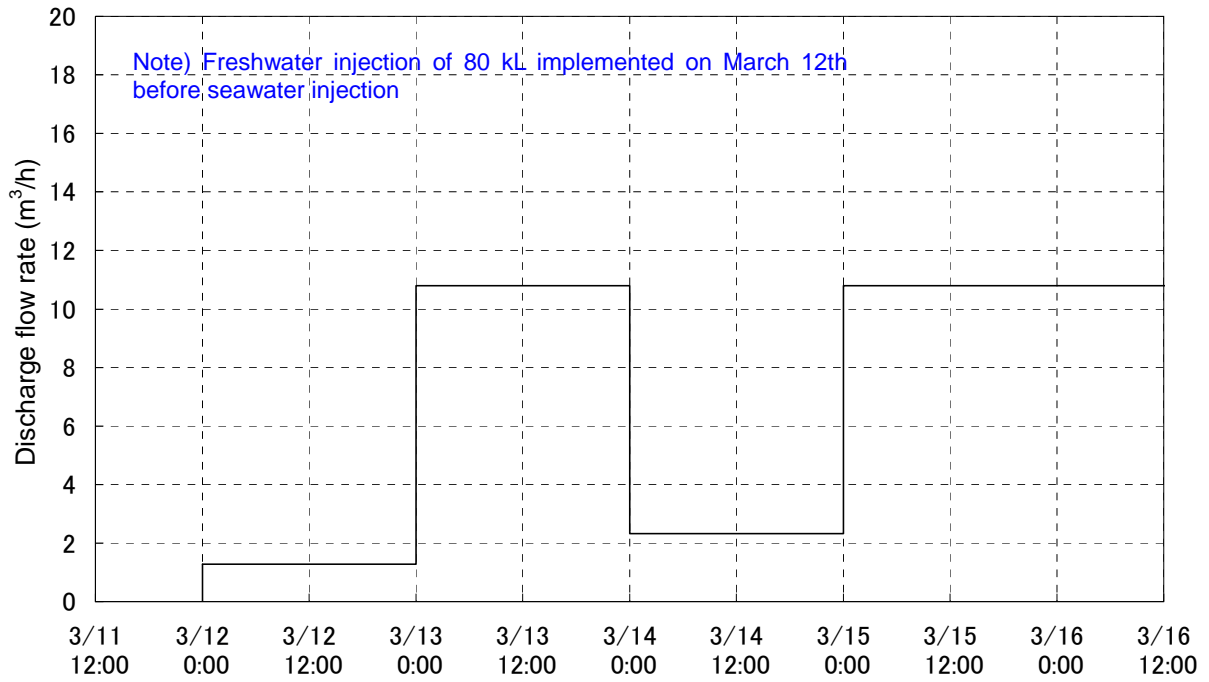

Figure 2 Average amount of seawater discharged by fire engine pumps (Unit-1)

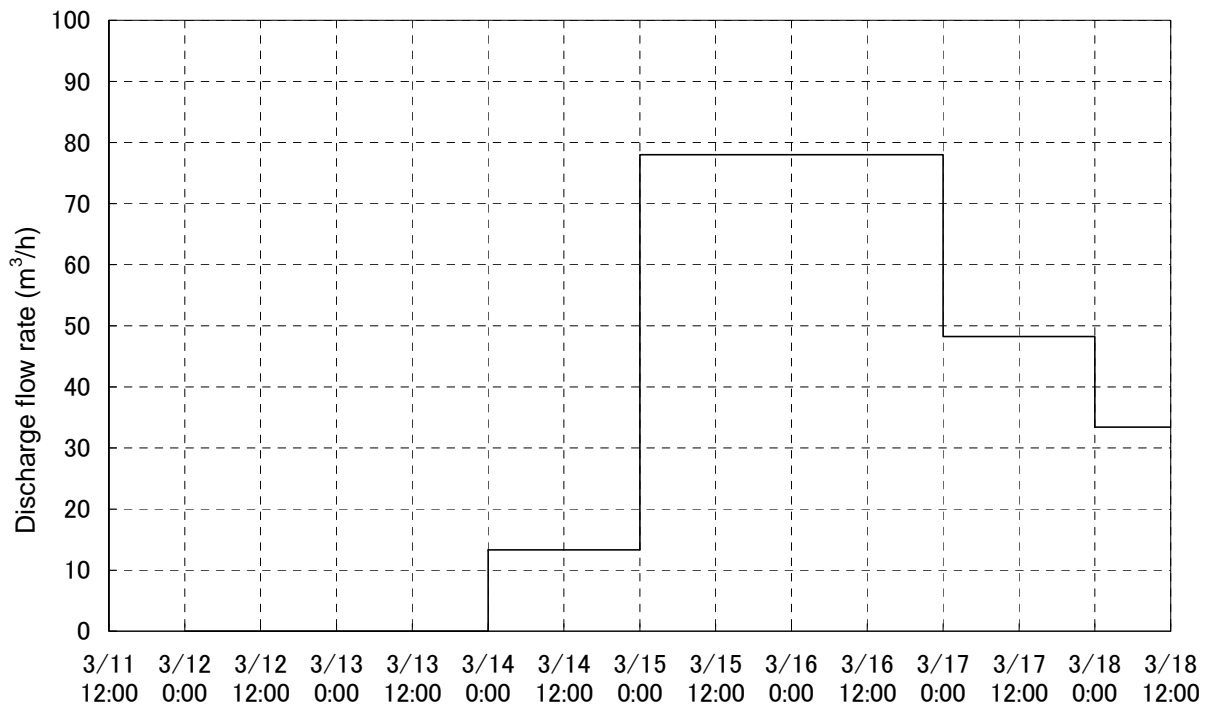

Figure 3 Average amount of seawater discharged by fire engine pumps (Unit-2)

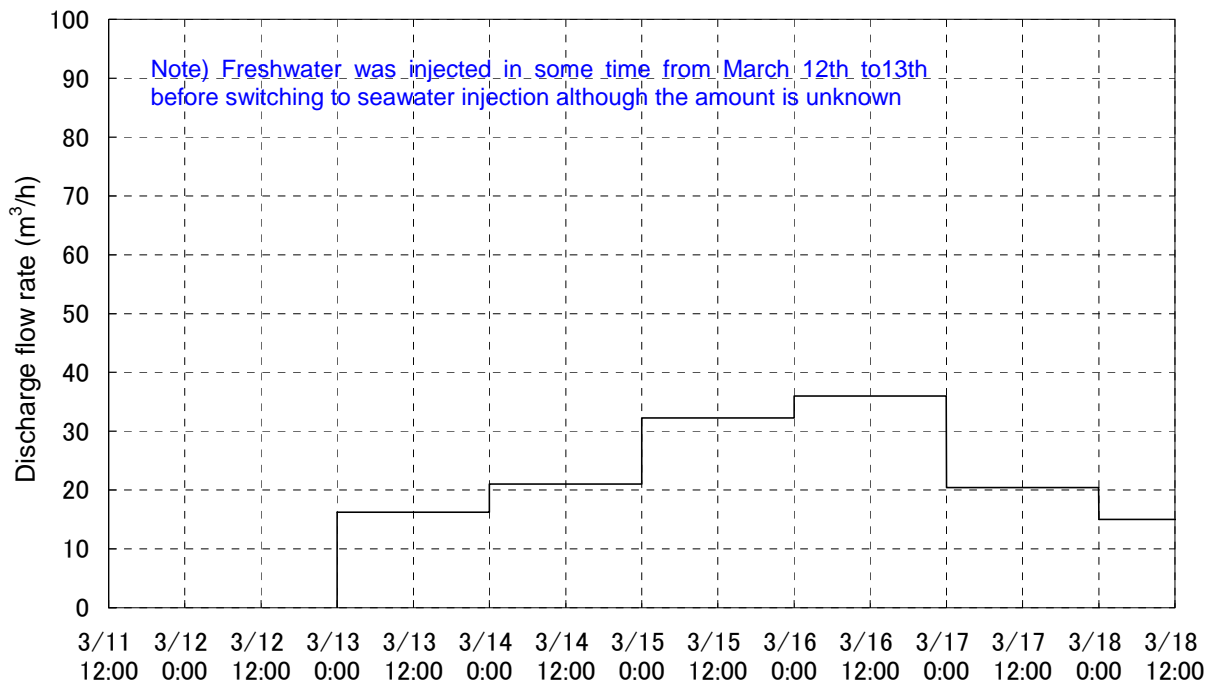

Figure 4 Average amount of seawater discharged by fire engine pumps (Unit-3)

Chronological records of alternative water injection to the reactors by fire engines in the early stage of the accident are summarized in Tables 1 to 3. Locations of fire engines and line connections between water source - fire engines - fire protection systems have been made open in Attachment 10-4 (3) of TEPCO report "Fukushima Nuclear Accident Analysis Report" in June 2012.

Table 1 Chronological records of maneuvering actions for alternative water injection (Unit-1). (The time when the water injection by fire engines was interrupted is colored in pink.)

Date & time	Actions	Remarks
Mar 12 <sup>th</sup> about 04:00	1300 tons of freshwater, carried by fire engines, injected into reactor via fire protection system lines	Alternative water injection line established at 20:50 on Mar 11 <sup>th</sup> using diesel-driven fire pump (DDFP). Pump started up, ready for water injection upon reactor depressurization. DDFP shutdown confirmed at 01:25 on Mar 12 <sup>th</sup> .
04:00 to 05:46	Water injection by fire engines interrupted	

Date & time	Actions	Remarks
05:46	Freshwater injection started into reactor via fire protection system lines by fire engines	In the early stage, water was pumped up from the fire protection water tank and fire engines were moved to the turbine building side for water injection. Later, water was injected via the continuous injection line connecting the fire protection water tank and fire protection system line water supply port.
14:53	Freshwater injection to reactor by fire engines. About 80,000 L in total supplied.	
14:53 to 19:04	Water injection line being configured with the Unit-3 water pit for switching the valve to the backwash condenser that contained seawater due to tsunami, as the water source	Unit-1 RB exploded at 15:36, damaging the hoses for seawater injection being prepared in parallel with freshwater injection
19:04	Seawater injection started by fire engines to reactor via fire protection system lines	
21:45 to 23:50	Seawater injection started by fire engines temporarily halted	
23:50	Seawater injection resumed	
March 14 <sup>th</sup> 01:10 to 20:00	Seawater injection temporarily halted because seawater inventory decreased in the Unit-3 water pit for switching valve to backwash condenser	
20:00	Seawater injection resumed	

Table 2 Chronological records of maneuvering actions for alternative water injection (Unit-2). (The time when the water injection by fire engines was interrupted is colored in pink.)

Date & time	Actions	Remarks
Mar 12 <sup>th</sup> 01:20	DDFP shutdown confirmed	Confirmed at 01:00 on Mar 12 <sup>th</sup> by stopping of smoke outside the exhaust duct, which had been confirmed earlier at DDFP start-up

Date & time	Actions	Remarks
Mar 14 <sup>th</sup> About 15:30	Fire engines connected to the fire protection system line water supply port started for seawater injection	Reactor pressure was still higher than fire engine pump discharge pressure. Standby status, ready for water injection upon reactor depressurization
18:02	Reactor depressurization started	
19:20 to 19:54	Fire engine shutdown confirmed at 19:20 due to no fuel. Water injection halted	The fire engine configured in the injection line was confirmed to have stopped 30 to 60 min before 19:20
19:54	Seawater injection started by fire engines (one each at 19:54 and 19:57) from fire protection system lines to reactor	

Table 3 Chronological records of maneuvering actions for alternative water injection (Unit-3). (The time when the water injection by fire engines was interrupted is colored in pink.)

Date & time	Actions	Remarks
Mar 13 <sup>th</sup> 09:25	Freshwater (including sodium pentaborate) injection started by fire engines from fire protection system lines to reactor	
12:20	Freshwater injection by fire engines completed	Water injection to reactor by DDFP, which was configured in the water injection line between 08:40 to 09:10, seems to have continued after fire engines terminated freshwater injection.
12:20 to 13:12	Line configuration underway for using seawater in the Unit-3 water pit for switching the valve to the backwash condenser	
13:12	Seawater injection started by fire engines from fire protection system lines to reactor	
March 14 <sup>th</sup> 01:10 to 03:20	Seawater injection temporarily halted because seawater inventory decreased in the Unit-3 water pit for switching the valve to the backwash condenser	

03:20	Water injection resumed for Unit-3 by relocating the water intake of the hose	
11:01 to about 15:30	Water injection interrupted due to Unit-3 hydrogen explosion	
About 15:30	Fire engines connected to the fire protection system line water supply port started for seawater injection to reactor	
19:20-19:54	Fire engine shutdown confirmed at 19:20 due to no fuel. Water injection halted	The fire engine configured in the injection line confirmed to have stopped 30 to 60 min before 19:20
19:54	Seawater injection started by fire engines (one each at 19:54 and 19:57) from FP system line to reactor	
21:14 to Mar 15 <sup>th</sup> 02:30	Seawater injection to Unit-3 temporarily halted to secure water for injection to Unit-2	
Mar 15 <sup>th</sup> 02:30	Seawater injection resumed by fire engines	

Figures 2 to 4 show the daily average amounts of seawater injected. When they are considered with the chronological records and other relevant changes of injected water, the amount of alternative water injected by fire engines can be shown as in Figures 5 to 7.

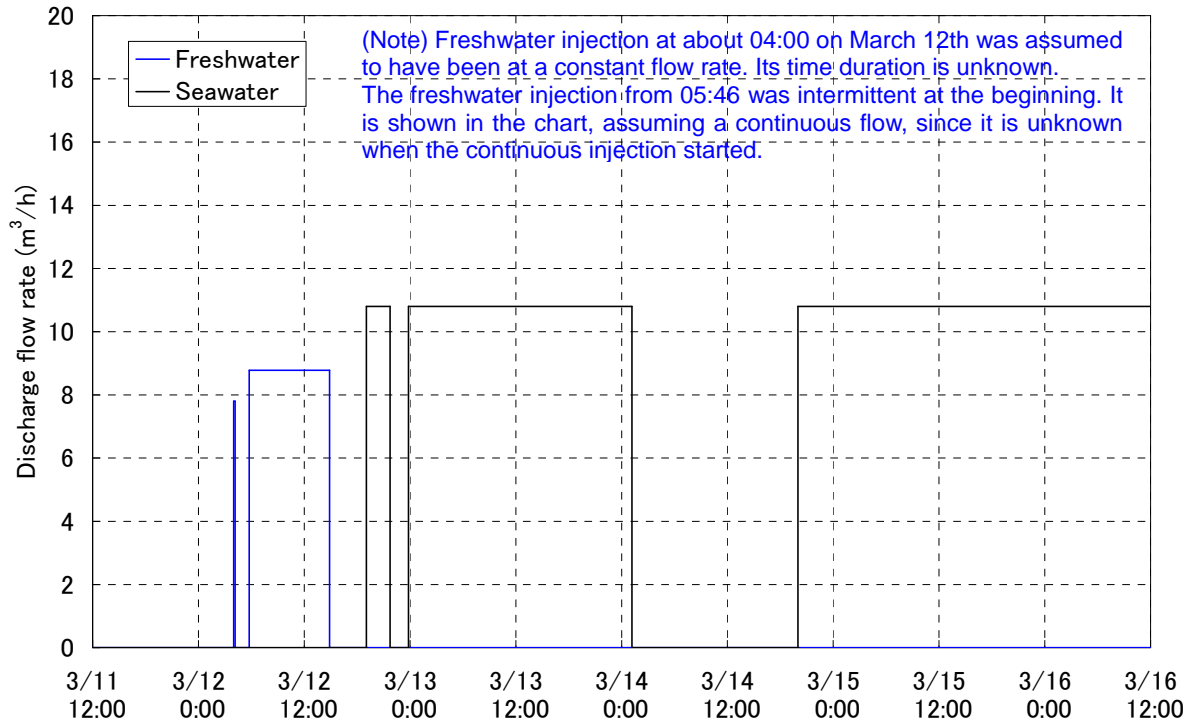

Figure 5 Amount of water discharged by fire engines (Unit-1)

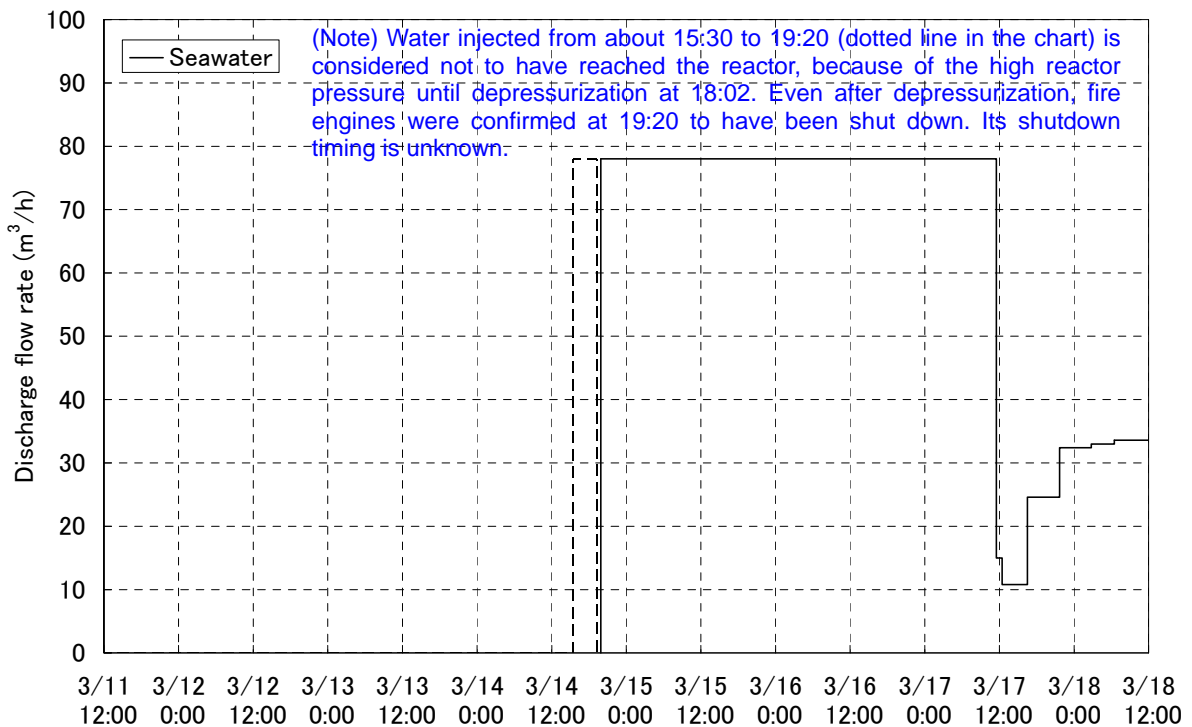

Figure 6 Amount of water discharged by fire engines (Unit-2)



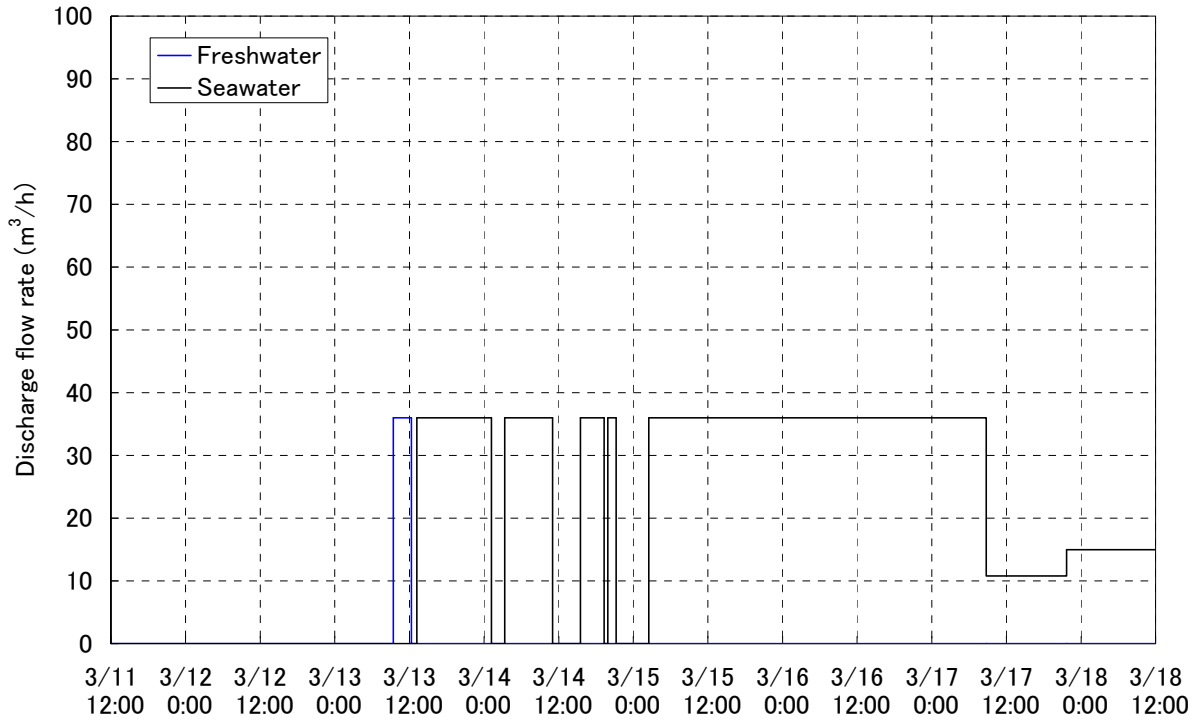

Figure 7 Amount of water discharged by fire engines (Unit-3)

As can be seen in Tables 1 to 3 and Figures 5 to 7, alternative water injection by fire engines was often interrupted in the early stage, especially at Unit-1 and Unit-3, due to water source depletion, hose damage by hydrogen explosions in buildings, etc. The next chapter reviews the plant behavior at these timings of initiation (restart) and termination of water injection.

### 3. Plant behavior at the time of alternative water injection to the reactor by fire engines

When fire engines started alternative water injection, the core is considered not to have been covered. When water was injected in such a situation, steam or hydrogen gas generated by water-zirconium reactions would increase reactor pressure and containment vessel (hereinafter referred to as PCV) pressure. Plant behavior at each unit is reviewed below for starting and interrupting water injection by fire engines.

#### 3.1. Unit-1 behavior upon water injection

Figure 8 compares the measured values of reactor water level by water level indicators and the MAAP (Modular Accident Analysis Program) analysis, which TEPCO made open in March 2012.

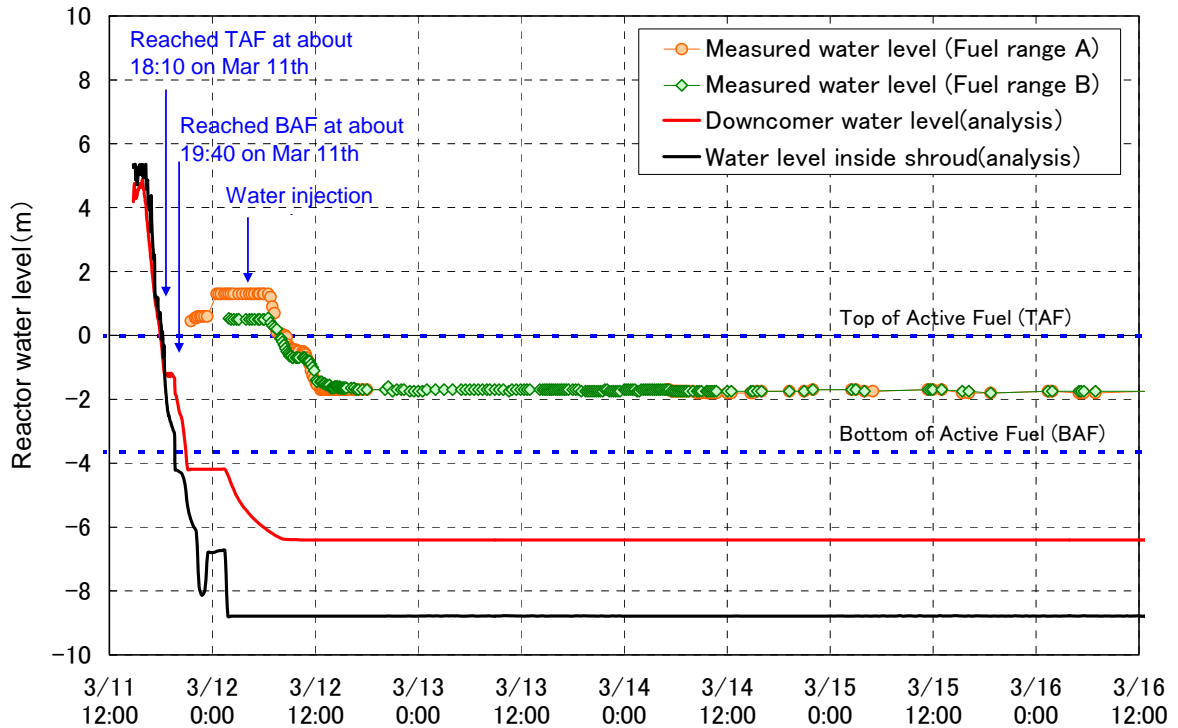

Figure 8 Water level changes at Unit-1.

Since the water inside the instrumentation tubes of the water level indicators evaporated due to the temperature rise in the PCV and other reasons, the measured values of water level may not be correct, as is discussed in Attachment 1-2. In the analysis, the isolation condensers (IC) (the system configuration is illustrated in Figure 9) were assumed to be out of service after the loss of all AC power supplies, since the opening degrees of their isolation valves (MO-1A and MO-4A) inside the PCV were unknown although the valve MO-3A was open between 18:18 and 18:25 and after 21:30, and the impacts of hydrogen gas generated after the fuel became uncovered or the reactor pressure decreased thereafter on the IC performance were unknown.

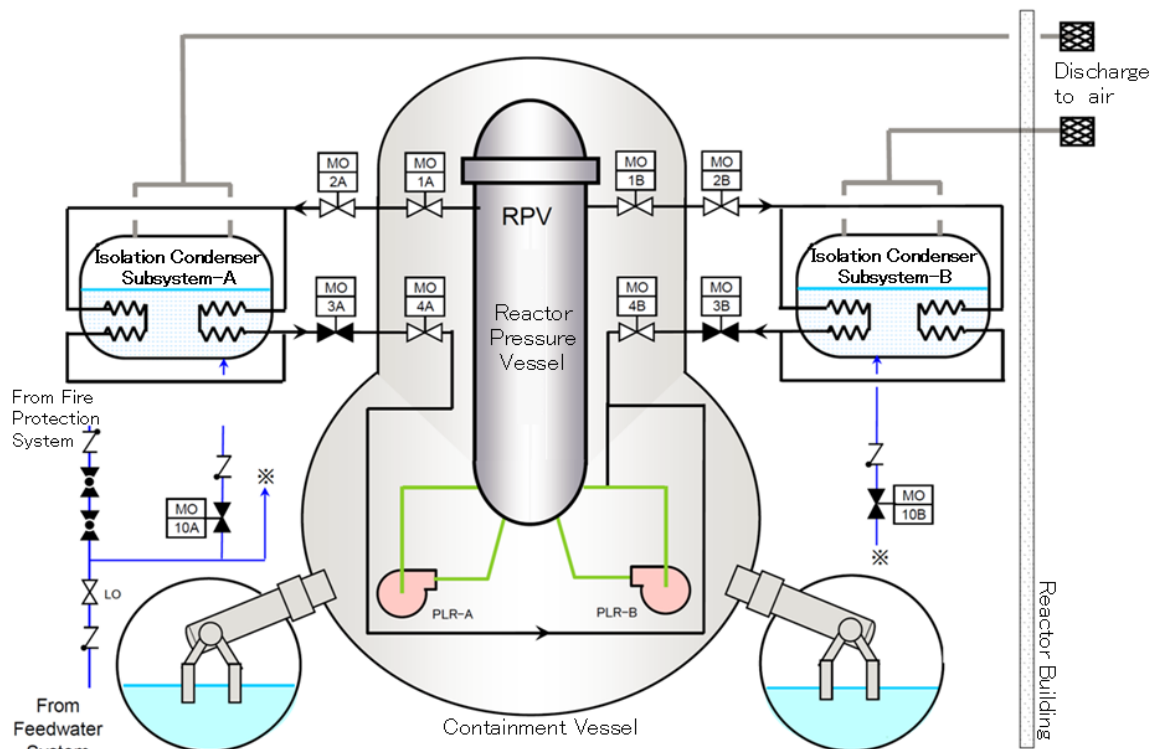

Figure 9 IC system configuration

Results obtained by MAAP predicted that the reactor water level reached the top of active fuel (TAF) at about 18:10 and the bottom of active fuel (BAF) at 19:40. In the MAAP analysis, the open state of IC valve MO-3A for 7 minutes from 18:18 to 18:25 on March 11<sup>th</sup> was not considered. In the earlier MAAP results which TEPCO reported in March 2012, the plant behavior was analyzed under the condition assuming the IC functions were kept and operated between 18:18 and 18:25 as well as from 21:30 on March 11<sup>th</sup> and 08:03 on March 12<sup>th</sup>. Comparing these two sets of results (with or without IC functions), it can be seen that the reactor water level reached BAF a bit later when the IC functions were assumed than when they were not assumed.

From 00:30 to about 06:30 on March 12<sup>th</sup>, the reactor water level indicators stayed at a certain constant value, although the levels were probably not correct. During this period, it can be interpreted, as it is discussed in Attachment 1-2, that the water level changes could not be detected and a constant water level was indicated, because the real reactor water level had fallen below BAF and reached the tap level of the reactor-side line of the water level instrumentation tube. As a matter of fact, the reactor water level indicator had shown the level at 00:30 on March 12<sup>th</sup> at the tap level of the reactor-side line of water level instrumentation tube. Thereafter, too, reactor water might have evaporated by decay heat. All in all, when the first alternative water injection started at about 04:00 on March 12<sup>th</sup> at Unit-1, residual water in the PCV D/W, including that of the reactor vessel, would have been very limited.

Figure 10-1 presents an overall change of the reactor pressure and PCV pressure, together with the discharge flow rate by fire engines, while Figure 10-2 presents the pressure changes in detail at the time of starting and ending of water injection.

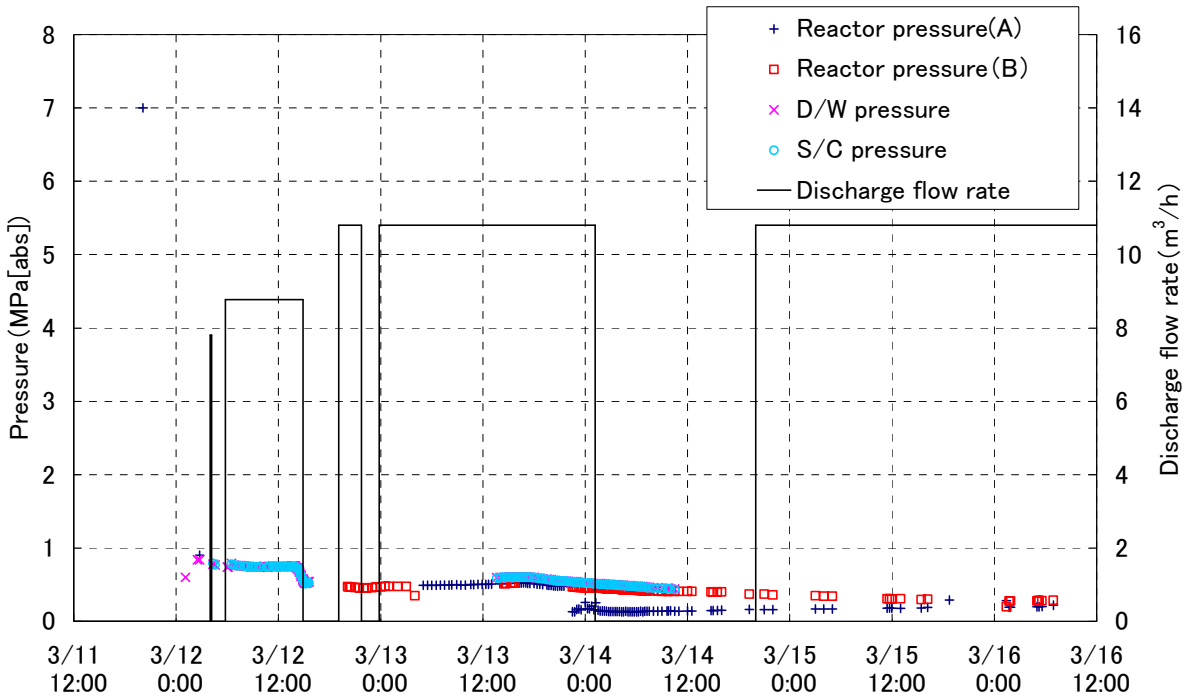

Figure 10-1 Reactor pressure and PCV pressure changes at Unit-1

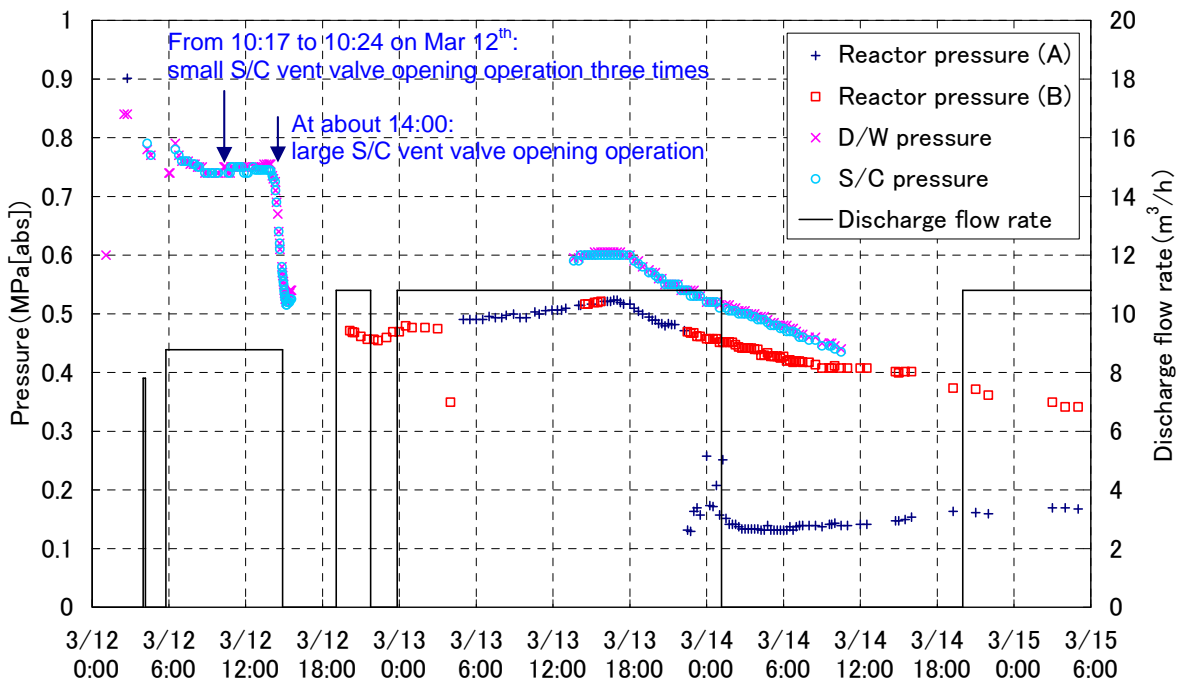

Figure 10-2 Reactor pressure and PCV pressure changes in detail at Unit-1

The PCV pressure was measured at 02:30 on March 12<sup>th</sup> as exceeding 0.76 MPa[abs], which was twice its design value, and the radiation dose rate in the main gate area increased between 04:00 and 04:23. These incidents being considered, it seems likely that some leaks had occurred at the PCV when the fire engines started to inject freshwater at about 04:00 and that this leakage caused the PCV pressure decrease. However, as seen in Table 4, PCV pressure recordings are

limited at about 04:00 when freshwater injection started/restarted or prior to 05:46, and therefore the trend of pressure changes is unknown prior to the start/restart of water injection. PCV pressure changes due to water injection are also not known in detail.

Table 4 Measured PCV pressures prior to and after the freshwater injection

Date & time	D/W pressure (MPa[abs])	S/C pressure (Mpa[abs])
Mar 12 <sup>th</sup> 01:05	0.6	—
02:30	0.84	—
02:45	0.84	—
about 04:00	About 1300 L of freshwater injected	
04:19	0.78	0.79
04:35	0.70	0.77
05:46	Freshwater injection started	
06:00	0.74	—
06:05	0.74	—
06:30	0.79	0.78

Freshwater injection was resumed at 05:46 and the PCV pressure increased from 06:05 to 06:30. The increase might have been caused by steam or hydrogen generated by water injection. But the measurement was only at two time points and there might be no connection between water injection and the PCV pressure increase. Other possible mechanisms of pressure increase could be due to steam or hydrogen generated by direct contact of fuel and water caused by fuel relocations, or due to hydrogen or carbon dioxide generated by core-concrete reactions. A reactor water level indicator, which measured constant values from 00:30 to 06:30 on March 12<sup>th</sup>, indicated a decrease at its next measurement at 06:47. As it is discussed in Attachment 1-2, this can be interpreted as due to a decreased water level in the water level instrumentation tube on the reactor side, which was caused by the increased PCV temperature.

Following the S/C venting shortly after 14:00 on that day, freshwater injection was completed. When it was stopped at 14:53 and at 21:45 when water injection was interrupted again, the PCV pressure indicated an increase. But the correlation is not certain between the pressure increase and interruption of water injection, because of other factors that need to be considered such as some time delay in pressure increase, fuel relocations, etc. At other timings of starting or interrupting water injection, too, the PCV pressure showed no clear changes in response with any correlation.

As discussed at the beginning of this document, part of the water injected might not have reached the reactor and the total amount of water actually injected is unknown. The plant status including the location and distribution of the heat source, i.e., fuel, also changes complicatedly with the incident development. In such circumstances, it is difficult to deduce probable situations

based on the limited sources of measurement information. Nothing exists to clearly identify direct correlations between water injection/interruption and plant behavior at the time of water injection or interruption.

### 3.2. Unit-2 behavior upon water injection

Figure 11 compares the values measured by reactor water level indicators and the MAAP analysis, which TEPCO made open in March 2012.

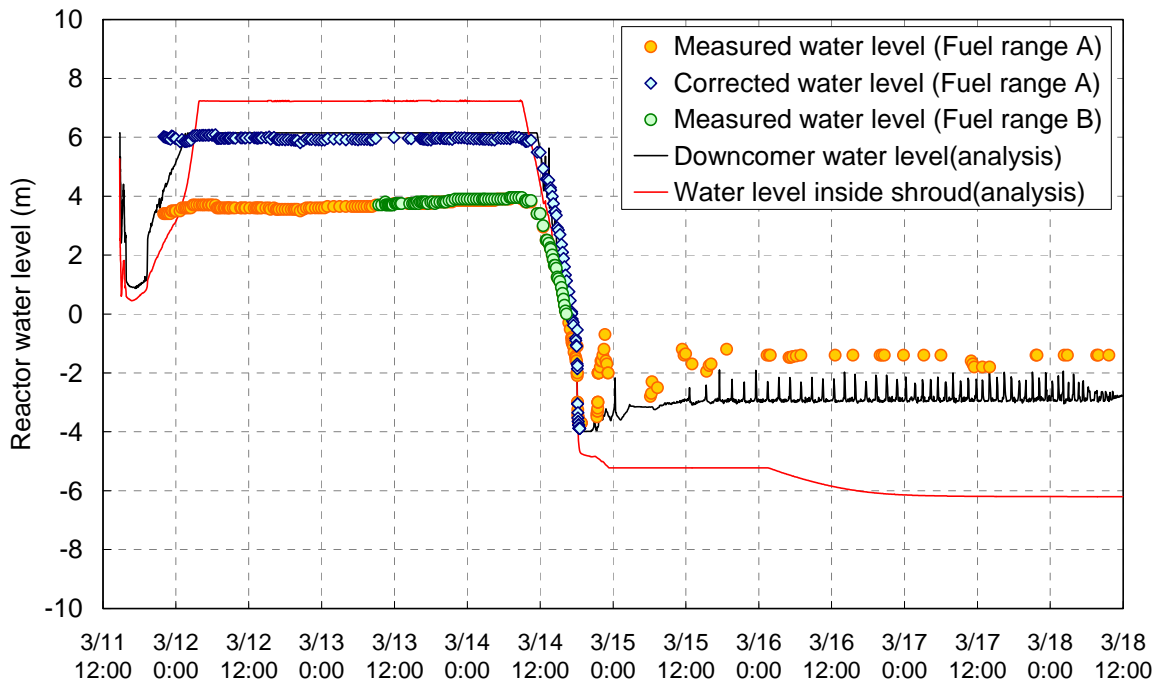

Figure 11 Water level changes at Unit-2.

After the earthquake, reactor water level of Unit-2 was controlled by repeating manual start-up of the reactor core isolation cooling (RCIC) and its automatic shutdown due to the high reactor water level. Immediately after the RCIC was manually started up for the third time, all power supplies were lost due to tsunami. Plant parameters measured thereafter, including the reactor water level, indicate the RCIC could continue to inject water for three days. The reactor water level measured (after correction) indicated TAF at about 17:15 on March 14<sup>th</sup> and it decreased sharply thereafter by flashing at the time of the forced SRV opening at 18:02, dropping below BAF. Therefore, it is considered that the reactor water level was lower than BAF when water injection by fire engines was started after the reactor had been depressurized.

Figure 12-1 illustrates the overall changes of reactor pressure and PCV pressure at Unit-2. Figure 12-2 illustrates the pressure changes in detail at the time of starting/interrupting the water injection. For the venting of Unit-2 PCV, the large S/C vent valve (air-operated) opened at 11:00 on March 14<sup>th</sup>, and the vent line configuration was completed except for the rupture disc. But the large S/C vent valve (air-operated) closed when the solenoid valve energizing circuit to supply

driving air to the valve was disconnected due to the Unit-3 building explosion at 11:01 on March 14<sup>th</sup>. Recovery work for the large S/C vent valve (air-operated) and operations for opening the small S/C vent valve (air-operated) were conducted, but it is not certain, including whether the rupture disc was working, whether the venting was actually implemented via the vent lines.

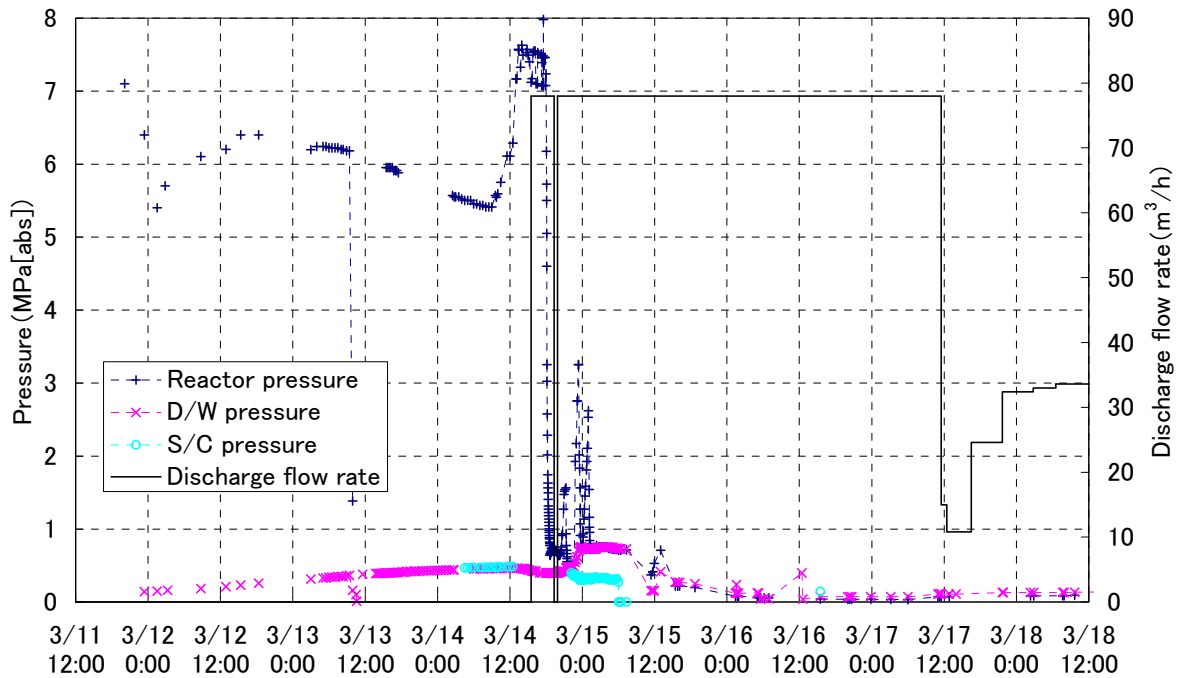

Figure 12-1 Pressure changes of RPV and PCV at Unit-2

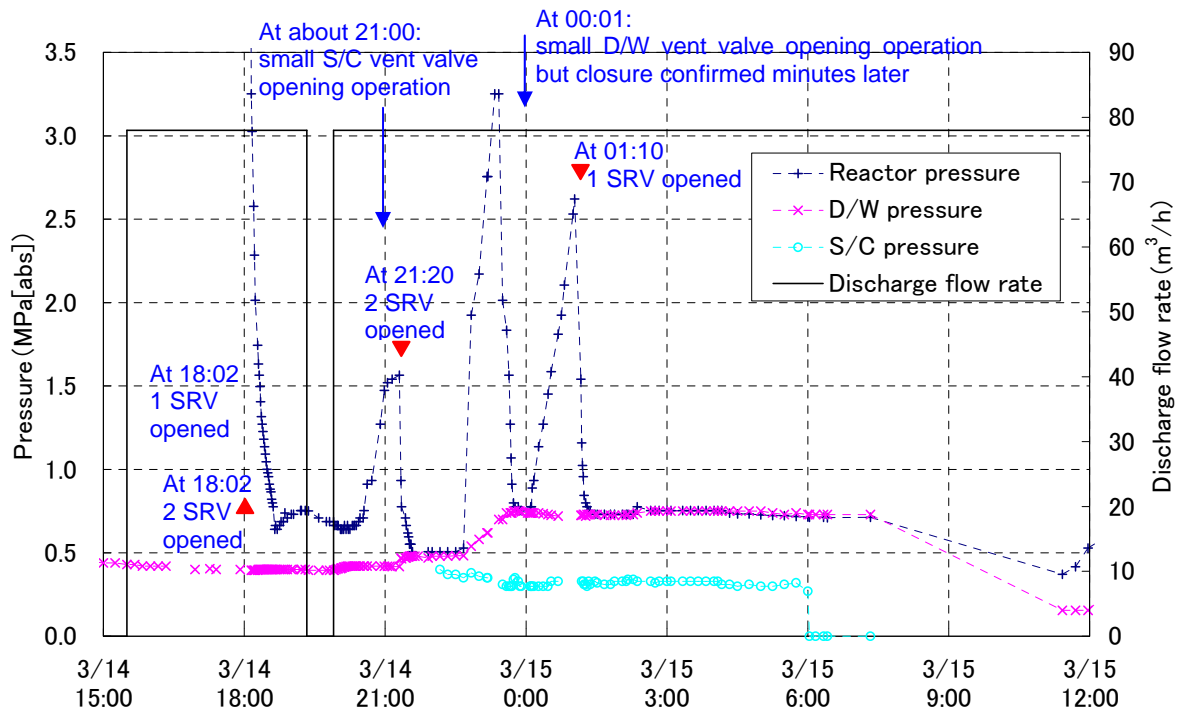

Figure 12-2 Pressure changes (detail) of RPV and PCV at Unit-2

At Unit-2, the reactor depressurization started at 18:02 on March 14<sup>th</sup> using the main steam safety relief valve (SRV). The pressure decreased thereafter to about 1 MPa[abs] at about 18:30. Fire engines had been started at 15:30, being made ready for water injection once depressurization began. However, a recorded conversation at about 19:20 from the video conference of the emergency response centers noted that the fire engine, which had been configured in the water injection line, had stopped about 30 minutes to one hour. The reactor pressure was in an increasing trend from 18:40 after depressurization. It might have been caused by steam or hydrogen generated by injected water after depressurization, but on the other hand the reactor water level constantly indicated lower limit of measurement until 18:47. These indicate that the water injection immediately after depressurization was a limited one.

Water injection by fire engines was resumed at 19:54 (March 14<sup>th</sup>) and the reactor pressure increased from about 20:15. Thereafter around the time when SRVs were opened, the reactor pressure dropped while the PCV pressure started to increase from the constant level until then. This would indicate that steam in the reactor was sent to the S/C via SRVs. As discussed above, the reactor water level of Unit-2 decreased to below BAF, and water injected through the LPCI piping reached the core region from below via the outside of the shroud and the reactor vessel bottom. As a consequence, steam might have been generated when water contacted overheated fuel as illustrated in Figure 13. The reactor pressure increase might be due to this steam generation, but this steam generation would be unlikely unless the water level reached the core region. This leads to an inference that, even if the SRVs had been closed before the opening operation at 21:20, plant parameters are not helpful to determine when it had occurred. The reactor pressure showed sharp peaks three times including this one. These pressure increases will be examined in detail elsewhere as Unit-2/Issue-12.

The maximum discharge pressures of fire engines were about 1 MPa[gage], and therefore the injected water might not have reached the reactor while the reactor pressure exceeded 1 MPa[gage]. If the reactor water level increase and pressure increase had a one-to-one correspondence, it might be possible to estimate the water actually injected, including interruption due to pressure increase. In the earlier MAAP analysis, which TEPCO had made open on March 12<sup>th</sup>, 2012, water injection was assumed to have been interrupted while the reactor pressure had exceeded 1 MPa[gage].



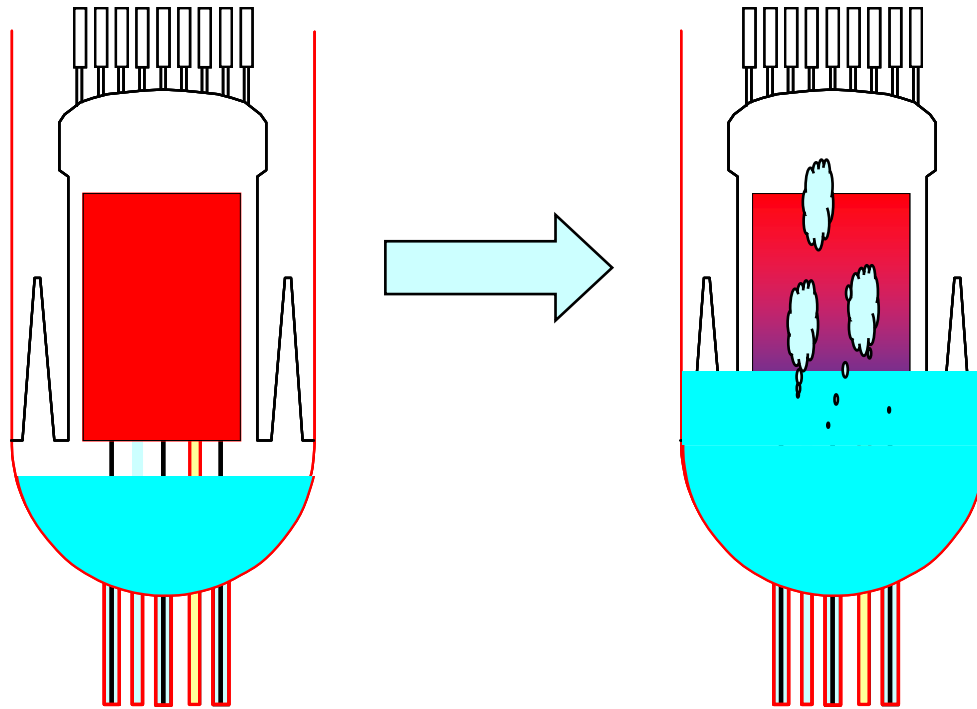

Figure 13 Steam generation and pressure increase upon water injection  
(When water level increases)

At Unit-2, CAMS data were recorded while core damage was developing. Figure 14 shows CAMS dose rate changes and measured pressures.

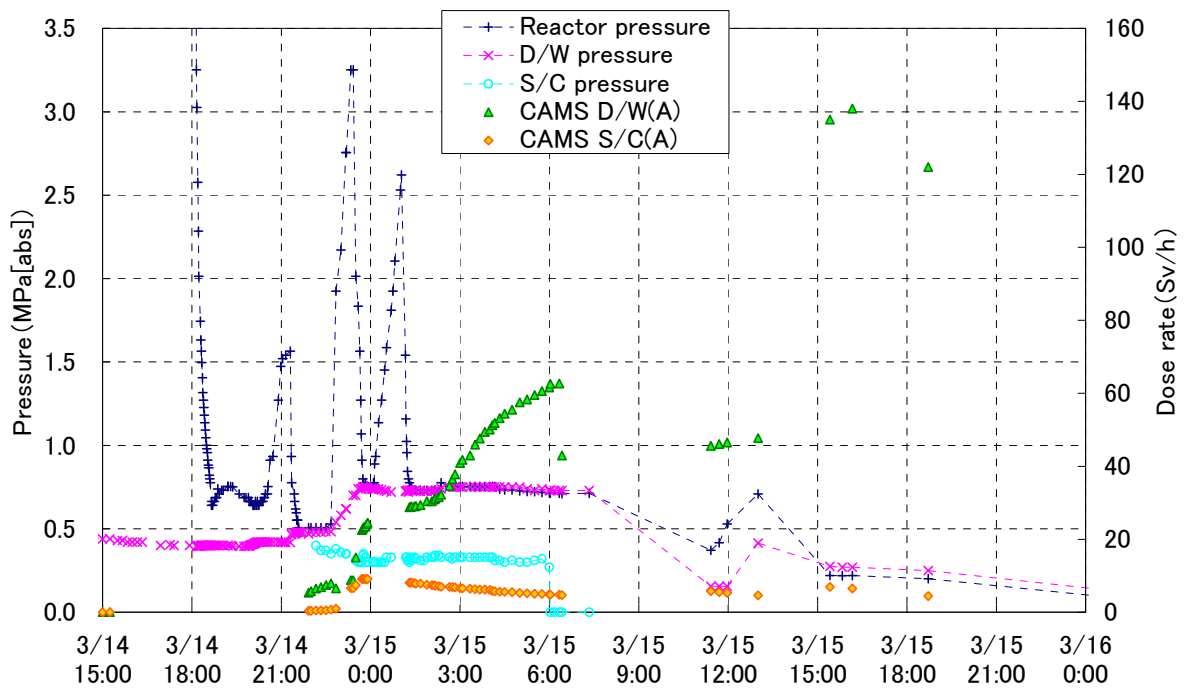

Figure 14 CAMS dose rate changes at Unit-2

The CAMS D/W (A) dose rate had increases two times and after the second increase at about 15:15 the dose rate decreased monotonously. Ultimately, molten fuel is considered to have

dropped and transferred to the PCV via the reactor pressure vessel at Unit-2, too. Therefore, a possibility can be considered that the molten fuel transferred to the PCV at this timing of the CAMS D/W (A) dose rate increase, about 15:15. In this case, it seems unlikely that the water injection interruption affected the consequences, because this second CAMS D/W (A) increase occurred more than half a day after the sharp rises in reactor pressures observed three times until about 01:20 on March 15<sup>th</sup> when water injection is considered to have been interrupted.

The first increase of CAMS D/W (A) dose rate can be considered as not due to water injection interruption, but due to steam discharge from the SRV, because: gas generated in the reactor immediately after depressurization by the forced SRV opening on March 14<sup>th</sup> was transferred to the S/C pool water through the SRV discharge piping; the uncondensed portion therein and incondensable gas moved to the S/C gaseous phase; and thereafter they were in a condition that they could be discharged to the D/W via the vacuum breakers.

### 3.3. Unit-3 behavior upon water injection

Figure 15 compares the values measured by reactor water level indicators and the MAAP analysis, which TEPCO made open in March 2012.

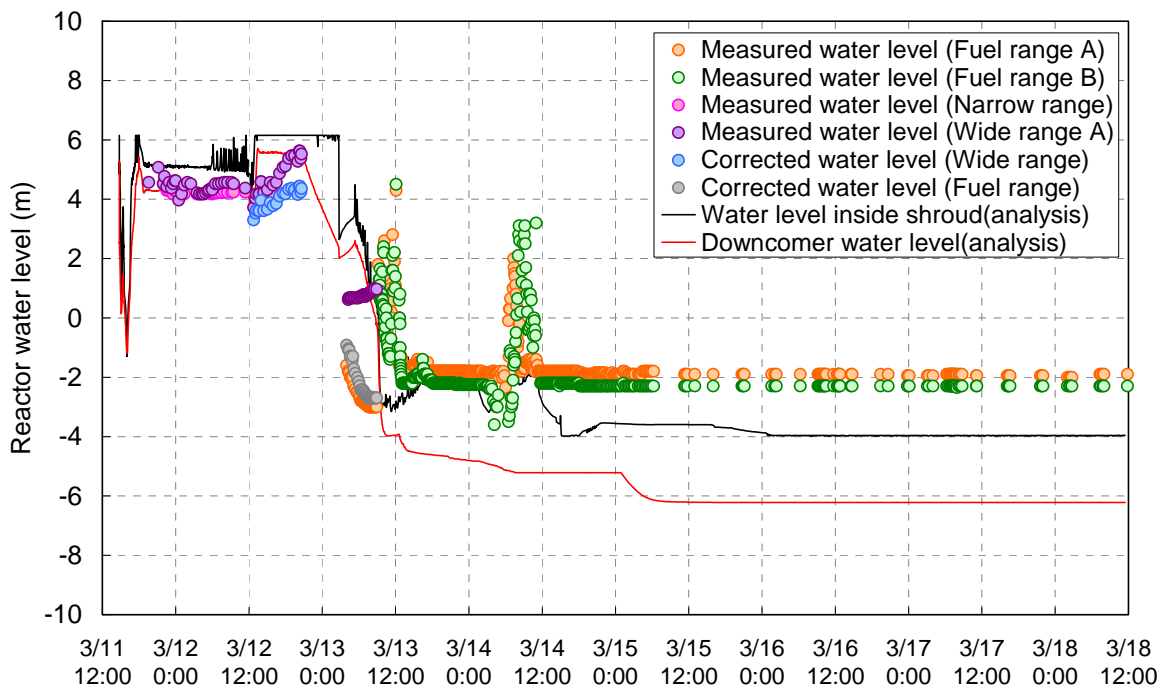

Figure 15 Water level changes at Unit-3.

At Unit-3, the RCIC system and high pressure cooling injection (HPCI) system continued water injection, as the DC power supply could survive the tsunami. The power supply to the reactor water level indicator was lost at 20:36 on March 12<sup>th</sup>. It was at 04:00 on March 13<sup>th</sup> after the HPCI had been shut down, when the water level indicator could resume and the measured water level was below TAF. As is discussed in Attachment 3-3, water injection to the reactor was very likely to have been lost before the HPCI was manually shut down at 02:42 on March 13<sup>th</sup>. MAAP analysis

overestimates the reactor water level, because it assumed that water injection had been continued until the HPCI was manually shut down. Thereafter, the fuel range water level indicator showed TAF-3m at 07:45 on March 13<sup>th</sup> and stayed there until 08:55. It is unlikely that the water level is kept at a certain level above BAF, because the decay heat is generated at the active fuel region. Therefore, the actual water level reached below BAF at this timing; thus the water level indicator indicated a certain constant value. This means that the actual water level in the reactor at 09:25, when fire engines started injecting water, was already far below TAF, and even below BAF.

The overall changes of reactor and PCV pressures at Unit-3 are shown in Figure 16-1, while Figures 16-2-1 and 16-2-2 show the pressure changes at the time of starting or interrupting water injection.

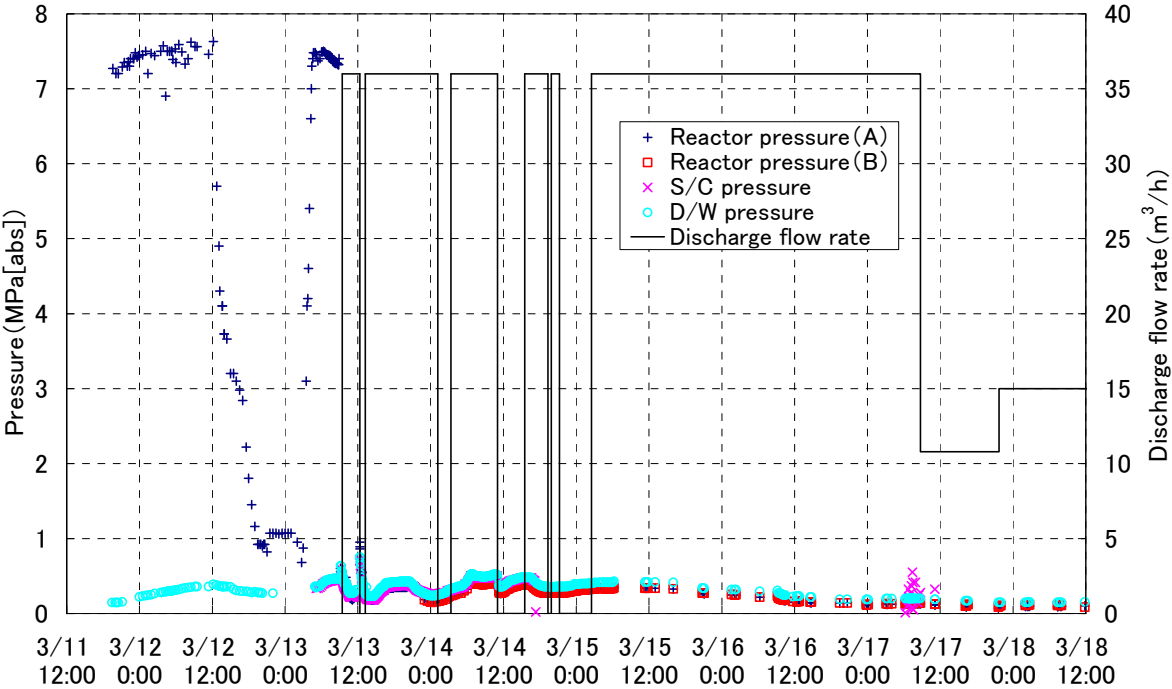

Figure 16-1 Pressure changes of the reactor and PCV at Unit-3

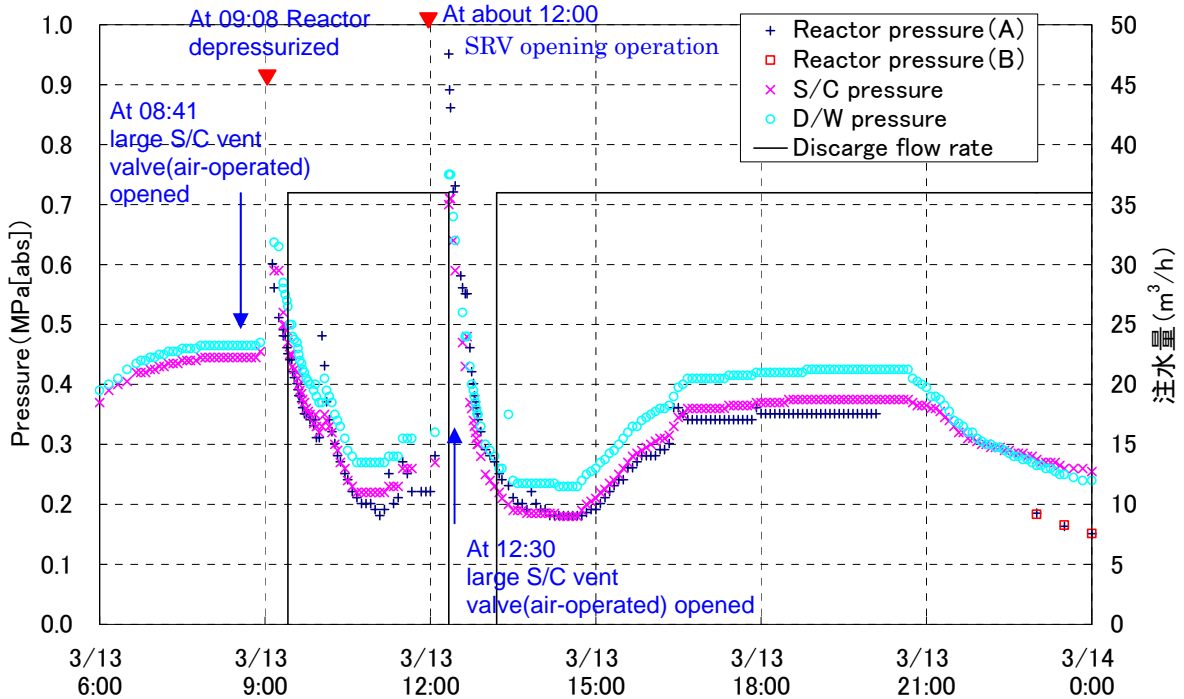

Figure 16-2-1 Pressure changes of the reactor and PCV at Unit-3 (Enlarged, 1)

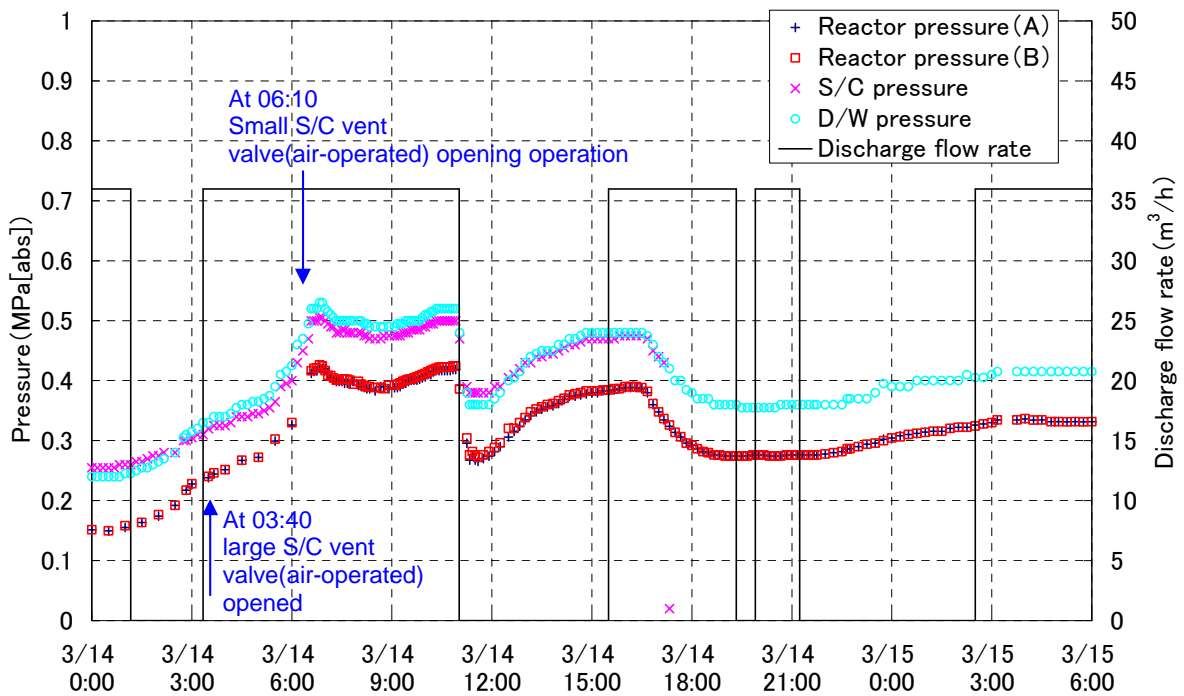

Figure 16-2-2 Pressure changes of the reactor and PCV at Unit-3 (Enlarged, 2)

At Unit-3, following the completion of the PCV venting line configuration, defects were noticed a few times and relevant work was conducted each time in order to keep the vent valve (air-operated) open: the temporary power supply for energizing the solenoid valve, energizing circuit, or driving pneumatic source. The chronological sequence of these events and actions taken are summarized in Table 5.

Table 5 Chronological sequence of maneuvering actions taken to keep the PCV vent valve open

Date & time	Actions
Mar 13 <sup>th</sup> 08:41	The large S/C vent valve (air-operated) opened and vent line configuration completed, except for the rupture disc
11:17	The large S/C vent valve (air-operated) closure confirmed because of pressure loss for the driving air cylinder.
12:30	The air cylinder replaced, the S/C vent valve (air-operated) opening confirmed
14:50	D/W pressure started to increase
About 19:00	A compressor was connected to the instrument air system (IA) and started up (opening of the large S/C vent valve (air-operated) confirmed at 21:00).
Mar 14 <sup>th</sup> 03:40	Defect found in the energizing circuit for the large S/C vent valve (air-operated), energized again
06:10	The small S/C vent valve (air-operated) opening operation

Water injection started at 09:25 using fire engines, when the plant conditions were as follows. After the HPCI was manually shut down at 02:42 on March 13<sup>th</sup>, preparations proceeded with water injection by the DDFP and fire engines. In parallel, battery connection work was underway to the energizing circuit for the solenoid valve of SRV air supply line as part of preparatory work for reactor depressurization in order to inject water by these low pressure injection measures. At 09:08 on March 13<sup>th</sup>, before the battery connection, the reactor depressurization started. Examination in detail into this pressure change is being done in Attachment 3-3. Further, as described in Table 5, at 08:41, before the reactor depressurization, the opening operation was taken for the large S/C vent valve (air-operated) and the S/C vent line configuration was completed except for the rupture disc. Following the start of reactor depressurization, the PCV pressure increased once and then decreased. This indicates that the S/C was vented. As mentioned earlier, the reactor water level before depressurization was way below TAF and possibly even below BAF. If water is injected under such conditions, steam and hydrogen generation will raise the reactor and PCV pressures. The pressure increase was observed twice at Unit-3, at about 10:00 and 12:00 and the pressure increase on these occasions was very steep, as can be seen in the reactor pressure change recorded in the charts (Figure 17), apparently different from the Unit-2 pressure increase. It may be possible that the Unit-3 pressure increase was caused by steam generated when the molten fuel fell into the water in the lower plenum, as illustrated in Figure 18. Based on these considerations, it might be possible that the difference in the pressure increase mode may help to estimate to what extent the water injected by fire engines actually reached the reactor or did not. The water level indicator, on the other hand, seems to have been already defective at this time, because it remained at TAF-3m before depressurization, but it showed a sharp rise to TAF+1.8m at 09:10.

At Unit-3, the reactor and PCV pressures mostly kept their trends with no visible impacts when

water injection started or interrupted. The only exception was when the pressure decreased when the water injection was interrupted due to the impacts of the Unit-3 reactor building explosion at 11:01 on March 14<sup>th</sup>.

There are still unclear behaviors concerning the reactor and PCV pressures after the reactor was depressurized at about 09:00 on March 13<sup>th</sup>. This issue is designated as Unit-3/Issue-8.

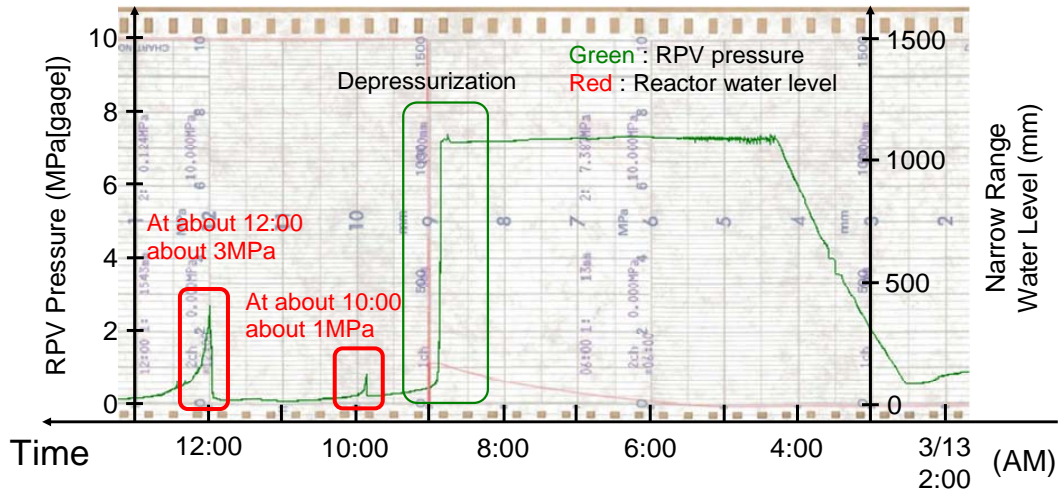

Figure 17 Reactor pressure increase after depressurization

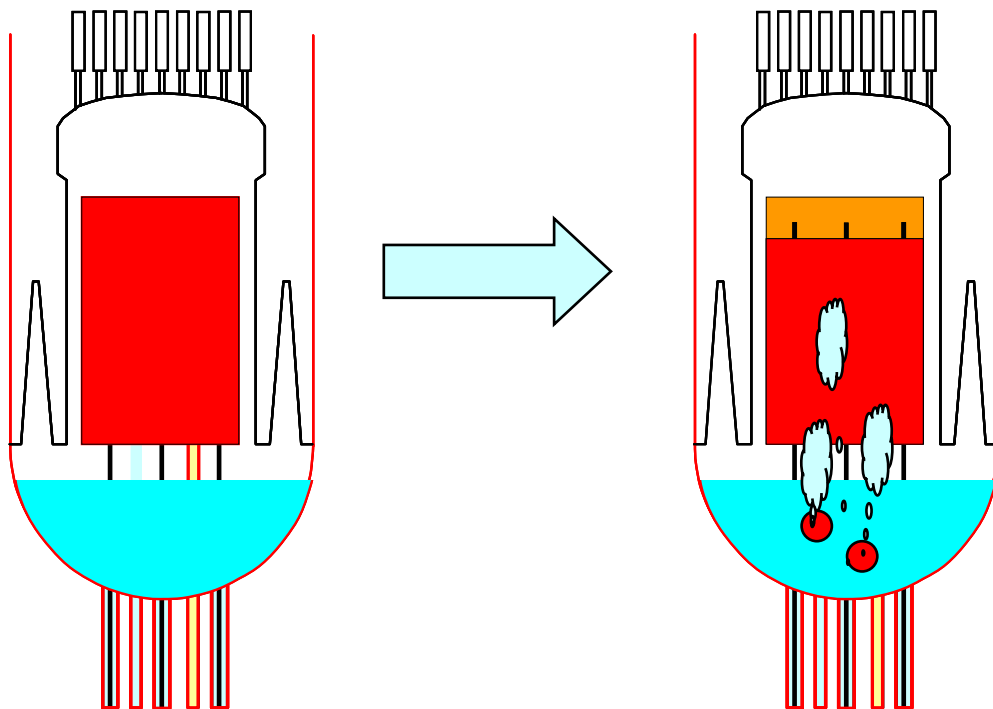

Figure 18 Steam generation and pressure increase upon water injection  
(Case: Falling down of molten fuel)

Through reviewing the plant responses to alternative water injection to the reactor by fire engines, it turned out that there were many cases in which plant parameters showed no visible responses to the commencement (restart)/ending of water injection. If the entire amount of water discharged was sent to the Unit-3 reactor, the reactor vessel would have been filled with water and the accident might have been terminated. It seems unlikely, therefore, that the entire amount of water discharged were sent to the reactor. The MAAP analysis by TEPCO also assumed a much smaller amount of water than the amount discharged as the input for calculating reactor cooling.

From the beginning of responses to the accident, the existence of branch lines was known on the piping & instrumentation drawings and the presence of accumulated water in the main condenser was confirmed. Therefore, there was the awareness that part of injected water had possibly been sent not to the reactor but to other systems and equipment. The next chapter reviews possible branch lines which could have sent water not to the reactor but to other systems and equipment.

#### 4. Possible bypass flow lines in reactor water injection line

At an early stage of responses to the accident, states (opened/closed) of the valves were checked on the piping & instrumentation drawings, etc. along the water injection lines for Units-1 to 3 which could bypass the injection lines to the reactor. Attached Tables 1 to 3 give the results, i.e., possible bypass lines, and Figure 19 presents their image.

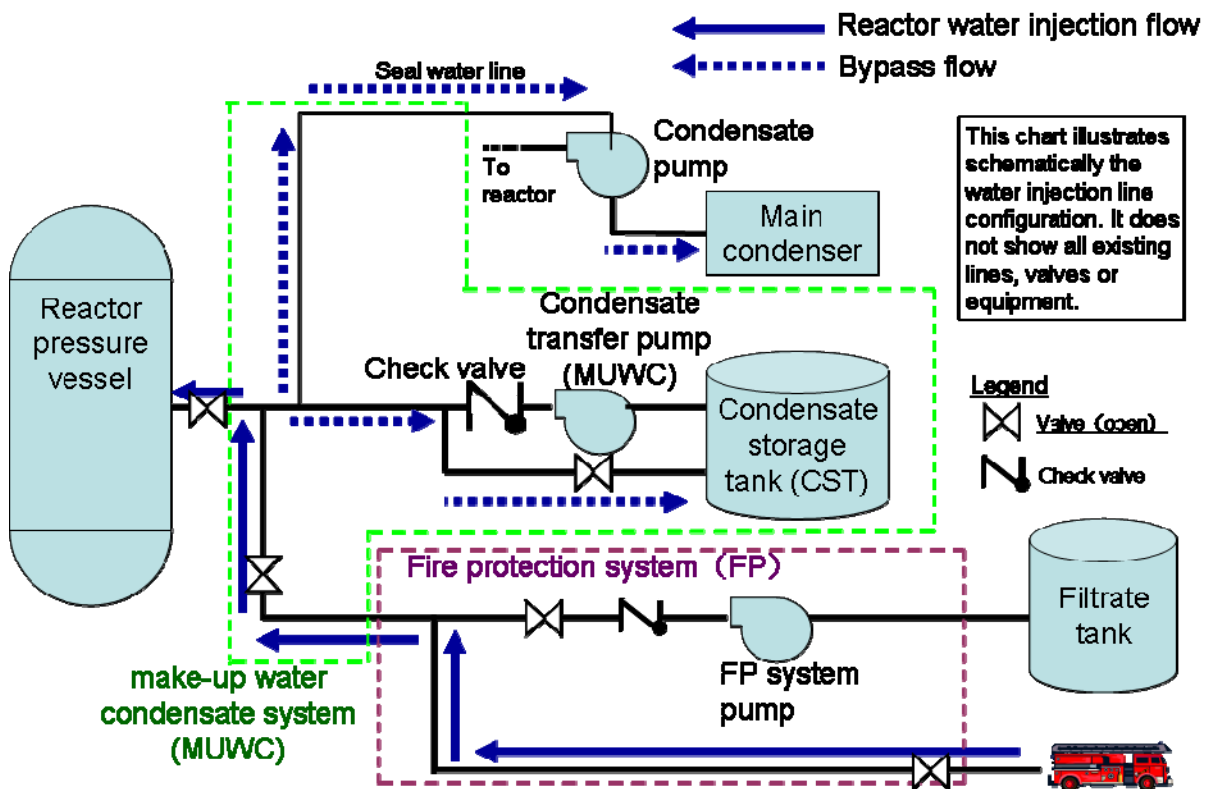

Figure 19 Image of bypass lines.

As was already described in Chapter 2, the alternative water injection by fire engines runs through the fire protection system and MUWC system. The MUWC system distributes condensates, during plant operation or shutdown, to various plant systems and equipment for cleaning and sealing, or to tanks and equipment for feeding water. If the MUWC, immediately before the earthquake, was distributing condensates as intended in the design and if the line configuration had been maintained after the earthquake, bypass flows could have occurred.

Possible bypass lines shown in Attached Tables 1 to 3 are explained below one-by-one.

- (i) Seal water lines of the condensate pump (Unit-1) and low pressure condensate pumps (Units-2 and 3)

The condensate pump is designed to send condensates from the condenser to feedwater pumps. Shaft seal water for the pump is supplied during normal operation through its own feedwater line mounted on its discharge, while in the start-up mode it is supplied from the MUWC through the external feedwater line. There is a possibility that the condensate pump tripped upon loss of external power supply in the accident, part of the alternative water injected was sent to the pump shaft through the external feedwater line and returned to the condenser via the pump suction side. An orifice was located on the line from the pump shaft to the suction side at Unit-1, while a constant flow valve was mounted on the seal water line at Unit-2 and Unit-3. In any case, the flow rate was limited if the injected water leaked through these lines.

- (ii) Minimum flow line of condensate transfer pumps

This line branches off from the pump discharge and returns water to the suction side for protective purposes. During alternative water injection by fire engines, the water was sent to the discharge line of the condensate transfer pump on the MUWC system via the fire protection system. As a consequence, part of the injected water might have returned through this line back to the condensate storage tank, which was the water source of the condensate transfer pumps. It should be noted that a flow control orifice was located on the minimum flow line.

- (iii) Gland steam evaporators for main turbines

During normal plant operations, the evaporators generate steam by evaporating the water from the MUWC system with turbine extraction steam as the heat source. This steam is supplied to the main turbine, reactor feedwater pump driving turbines (RFP-T) and their steam valve gland portions as seal steam so that air inflow into, or steam leak from, the inside of the gland is prevented. In the accident at the Fukushima Daiichi, the main steam isolation valves were closed and the evaporators lost their heat source. The water level control valve mounted on the feed water line from the MUWC to evaporators was designed to open upon loss of power supply. This suggests a possibility of injected water having been sent to the condenser via evaporators.



(iv) Valve seal water

Valves mounted on the lines around the condenser receive seal water at their gland portions from the MUWC system, if their corresponding system lines are under negative pressure, in order to prevent the lines from air inflow. Even during normal plant operations, part of the seal water, although the amount is limited, flows into the system lines. Part of the water injected might have flowed into the system lines, too.

(v) Seal water lines of liquid waste neutralization pumps

The liquid waste neutralization pump is started up when sending liquid waste to the central radioactive waste treatment facility after pH adjustment. At Unit-1, the seal water supply valve for the subject pump was an air-operated valve and it opened when the driving air was lost. This indicates a possibility that the water injected through the MUWC might have flowed into the liquid waste system through the seal water line and pump.

(vi) Seal water lines for the vacuum breaker valves of condenser

The vacuum breaker valves of the condenser are installed to break the vacuum of the condenser by taking in air and they are closed during normal plant operations. The seal water for the vacuum breaker valves was supplied from the MUWC system to the air side of the valves in order to prevent air inflow from the valve seat to the inside of the condenser.

The seal water inlet valve of Unit-1 was always slightly open so that the overflowed water was collected in the condenser. Therefore, part of the water injected by fire engines could have flowed into the condenser as in normal plant operations. At Units-2 and 3, on the other hand, there were no such flows because the seal water inlet valve was normally closed and opened for water make-up only when a "low seal water level" signal was issued.

(vii) Mechanical seal lines of PLR pumps

Purge water for the PLR pump mechanical seals is supplied from the control rod drive hydraulic (CRD) systems during normal operation. The water source for the CRD is the MUWC or condensate demineralizer (CD) outlet of the condensate/feedwater system. Unit-1 had an air-operated valve between the MUWC and CD outlet, which opened upon loss of driving air. This indicates a possibility that part of the water injected through the MUWC could have flowed into the equipment drain sump via PLR mechanical seals.

(viii) Seal water lines of feedwater pumps

At Unit-1, seal water was supplied to the feedwater pumps from CD outlet, which meant the MUWC and CD outlet were connected by piping, because the CRD received water from the MUWC or CD outlet, as mentioned in (vi). This indicates a possibility that part of the water injected through the MUWC could have flowed into the condenser via feedwater pump shaft seals.

(ix) Condensate demineralizers

For the same reason, the path from the CD outlet to the CD demineralizer column could have been a bypass line at Unit-1 for injected water.

(x) Seal water for low pressure heater drain pumps

Unit-1 supplied seal water to the low pressure heater drain pumps from the CD outlet. The seal water supply valves of the pumps were opened before starting up at plant start-up, indicating a possibility that part of the water injected could have flowed into the equipment drain sump via CD outlet and seals of low pressure heater drain pumps.

5. Measures for bypass flows

The following measures are being taken at the Kashiwazaki-Kariwa Nuclear Power Station for preventing possible bypass flow lines for reactor water injection.

(i) Adding a master valve (motor operated valve) to the make-up water condensate (MUWC) system supply line for the turbine building

A motor operated valve (master valve) was added to the pipe to send condensate from the reactor building to the turbine building so that unnecessary bypass lines could be blocked on the make-up water condensate (MUWC) system in the turbine building. In the emergency operation procedures (tsunami accident management), it has been specified to close this valve upon receiving a major tsunami warning. This valve can be closed on site in case this cannot be done from the main control room.

(ii) Seismic reinforcement works for the MUWC system

Seismic reinforcement works were made for the make-up water condensate (MUWC) system for reducing the risks of forming new bypass lines by pipe damage, etc.

(iii) Additional installation of hose connection mouthpieces for fire engines

Hose connection mouthpieces for fire engines were added to the make-up water condensate (MUWC) system, which reduces the risks of forming new bypass lines by the above measures (i) and (ii).

At the Kashiwazaki-Kariwa Nuclear Power Station, the check valves of the condensate transfer pump discharge are originally installed downstream from the branch to the minimum flow line, excluding bypass flows via the minimum flow line, which differs from Units-1 to 3 at the Fukushima Daiichi Nuclear Power Station. Figure 20 illustrates the above-mentioned measures at Unit-7.

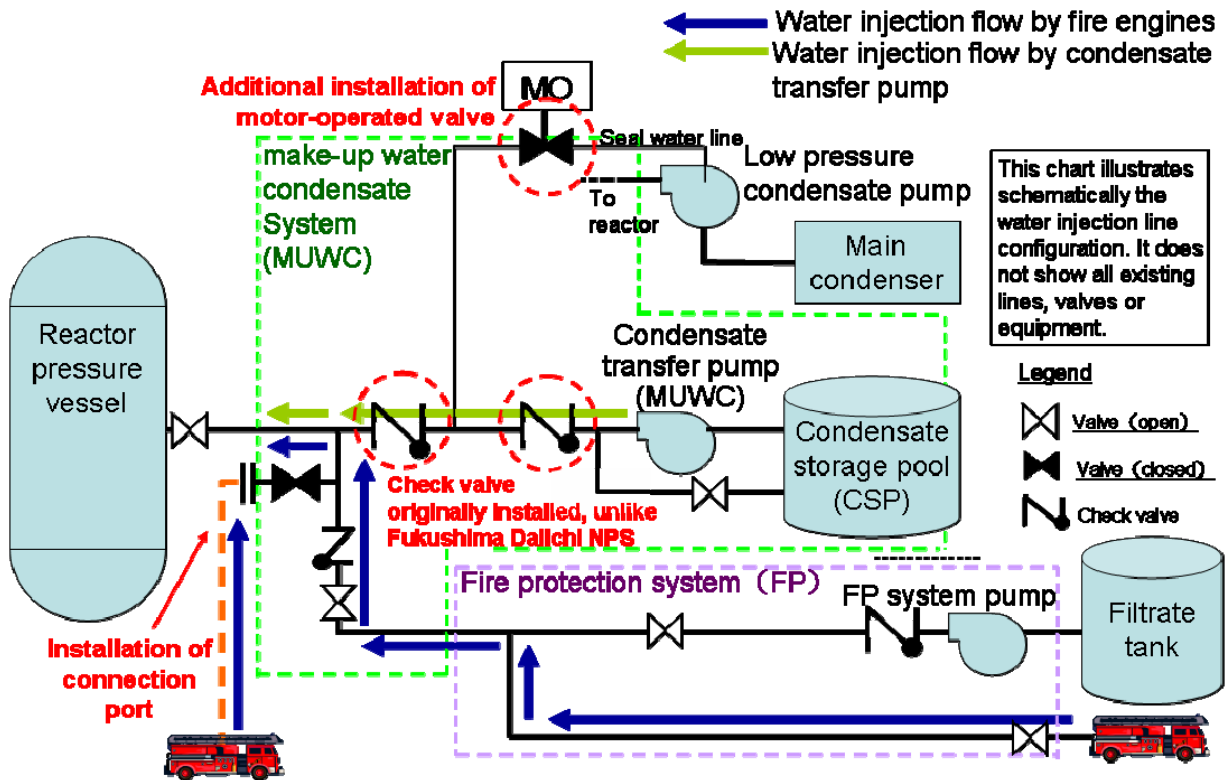

Figure 20 Overview of measures being taken at Kashiwazaki-Kariwa Nuclear Power Station (Unit-7) for water injection bypass flow lines

## 6. Summary

The amounts of water injected by fire engines at the pump discharge point have been determined in more detail than the daily averages made public previously, based on the chronological information and plant parameters known. Possible bypass flow lines have been identified between fire engines and the reactors based on the piping & instrumentation diagrams.

Attached Table 1 Possible bypass flow lines at Unit-1

No	Leak path	Pipe diameter	Remarks
1	Seal water line of condensate pump	3/4"	Flow to condenser
2	Minimum flow line of condensate transfer pump	4"	Flow to condensate storage tank
3	Evaporator make-up water line	2"	Flow to condenser
4	Seal water of valves	1/2"	Flow to system line
5	Seal water line of liquid waste neutralization pump	3/4"	Flow to system line
6	Seal water line of condenser vacuum breaker valve	3/4"	Flow to condenser
7	Mechanical seal water line of PLR pump	3/4"	Flow to equipment drain sump
8	Seal water line of feedwater pump	1"	Flow to condenser
9	Condensate demineralizer	8"	Flow to condensate demineralizer column
10	Seal water line of low pressure heater drain pump	3/8"	Flow to equipment drain sump

Attached Table 2 Possible bypass flow lines at Unit-2

No	Leak path	Pipe diameter	Remarks
1	Seal water line of low pressure condensate pump	2"	Flow to condenser
2	Minimum flow line of condensate transfer pump	2"	Flow to condensate storage tank
3	Evaporator make-up water line	2.5"	Flow to condenser
4	Seal water of valves	1/2"	Flow to system line

Attached Table 3 Possible bypass flow lines at Unit-3

No	Leak path	Pipe diameter	Remarks
1	Seal water line of low pressure condensate pump	2"	Flow to condenser
2	Minimum flow line of condensate transfer pump	2"	Flow to condensate storage tank
3	Evaporator make-up water line	3"	Flow to condenser
4	Seal water of valves	1/2"	Flow to system line