

# Basic Specifications for Smart Meter Communications

March 21, 2012

The Tokyo Electric Power Company, Incorporated



TOKYO ELECTRIC POWER COMPANY

---

# Introduction

---

This document summarizes current TEPCO's precondition of the basic concept for the functions of smart meter communication network.

TEPCO & Nuclear Damage Liability Facilitation Fund widely request your comments for concepts and specifications regarding the whole metering system that could rationalize business management by optimizing specification and reducing procurement cost.

At this request for comment, We will request not only communication technology specification but also precondition of our communication network. We welcome your wide range of comments and suggestions concerning the matters to be considered from a technical standpoint, functions for efficient implementation, cost reduction, quality and function improvement, business efficiency, and the one which is on concept level.

Although this document explains the concept of our communication network, we also welcome your comments on both metering part and communication part of smart meter, as well as other metering related systems.

Ideas and comments that contribute to cost reduction and efficiency of construction and operation will be positively reflected into the specification.

# Future Procedure

---

In order to decide the communication system to implement using basic specification based on the submitted comments (precondition of smart meter communication network, concept for selecting communication system and so on), technical field test has to be done considering full-scale deployment.

Therefore, Request For Proposal (RFP) including field test about the submitted technology which has advantage in cost, function, quality and so on will be planned afterwards.

Technology which are acknowledged to have advantage at the stage of field test will go on to preparatory stage for full-scale deployment.

---

## - Table of Contents -

- I. Preconditions for Smart Meter Communication Network
- II. Concept for Selecting Communication System
- III. System Overview of RF Mesh Network

---

# I. Preconditions for Smart Meter Communication Network

1. Features of Smart Meter Communication Networks
2. Requirements for Smart Meter Communication Networks
3. Functions of Smart Meter

## II. Concept for Selecting Communication System

## III. System Overview of RF Mesh Network

Chapter I describes the preconditions of our smart meter communication network. The wide range of comments and suggestions concerning this preconditions are appreciated that could contribute to cost reduction and improvement of quality and functions.

## I-1. Features of Smart Meter Communication Networks

- Smart meter communication network realizes the transmission from smart meters installed at customer houses to Meter Data Management System (MDMS), and remote switch control from MDMS.
- There is a need to take into account various regional conditions such as high-density residential areas, underground malls, high-rise apartment buildings, suburban areas, and mountainous areas in order to serve our 27 million customers.

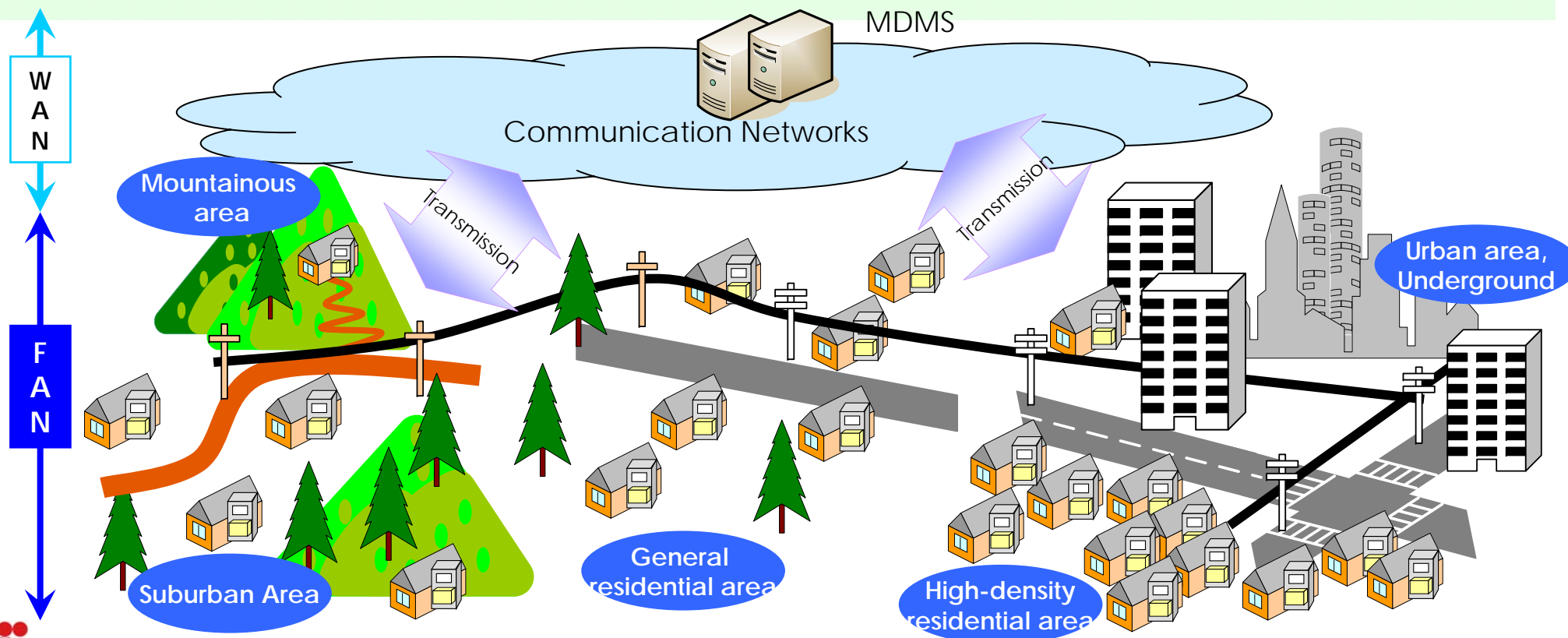

## I-2. Requirements for Smart Meter Communication Networks

---

1. Transmit and collect data reliably from each meter
  - Despite its small size per customer, the data collected from a vast number of meters must be transmitted to MDMS.
2. Ensure the data security
  - Robust security must be ensured against the threats of illegal access or information leakage because this communication network handles the data related to customers' privacy including the electricity use.
3. Maintain and manage the communication network effectively and properly
  - Install management function and rapid recovery function from failure to maintain healthy communication.
4. Continue running for a long time
  - Selecting a communication system to be used for a long time is essential by considering penetration prospects and continuous usage since smart meter will be used for 10 years after installation.
5. Construct and maintain at low cost
  - As for a vast number of smart meters, it is important to suppress not only the initial cost but also the TCO (Total Cost of Ownership), including the maintenance cost of the communication network.

### I-3. Functions of Smart Meter (1) - 30-minute meter reading -

- Smart meters measure and transmit 30-minute meter readings to MDMS.
- When a 30-minute meter reading is lost, MDMS checks that the communication with the meter is recovered. The meter retransmits the data in response to a recollection request from MDMS.

<Periodic Collection>

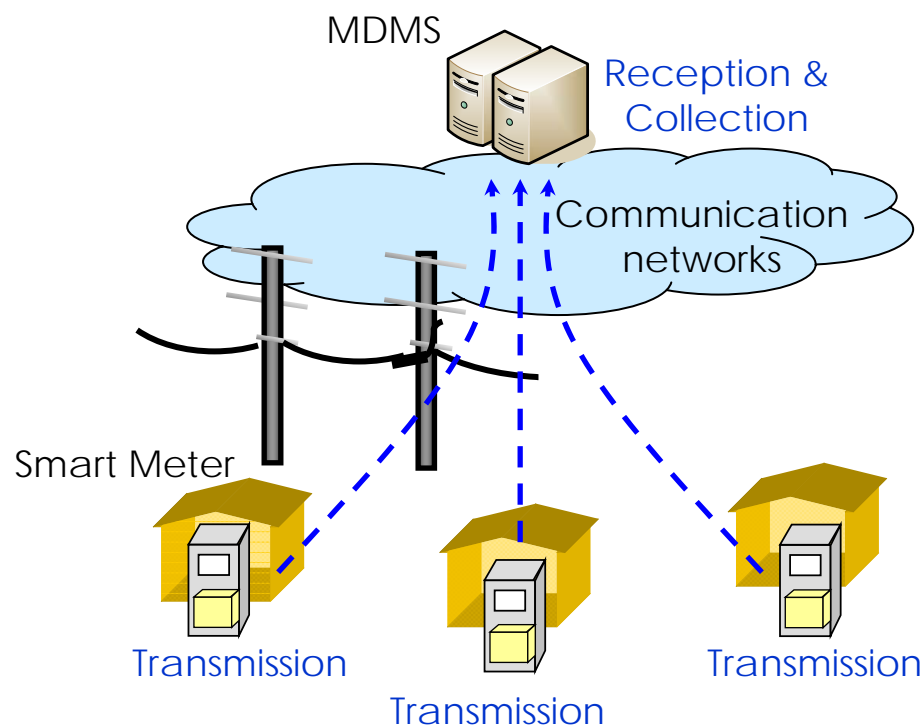

<Individual Collection (loss of data)>

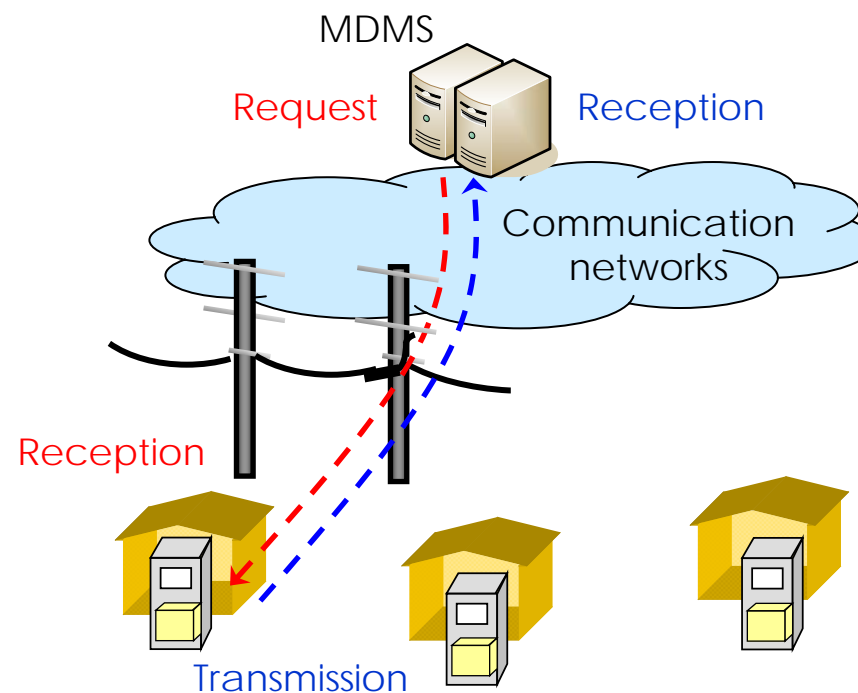



### I-3. Functions of Smart Meter (2) - meter setting & control -

- The smart meter that received the setting and control request data for switch control and others from MDMS executes the requested process, and transmits the results to MDMS.

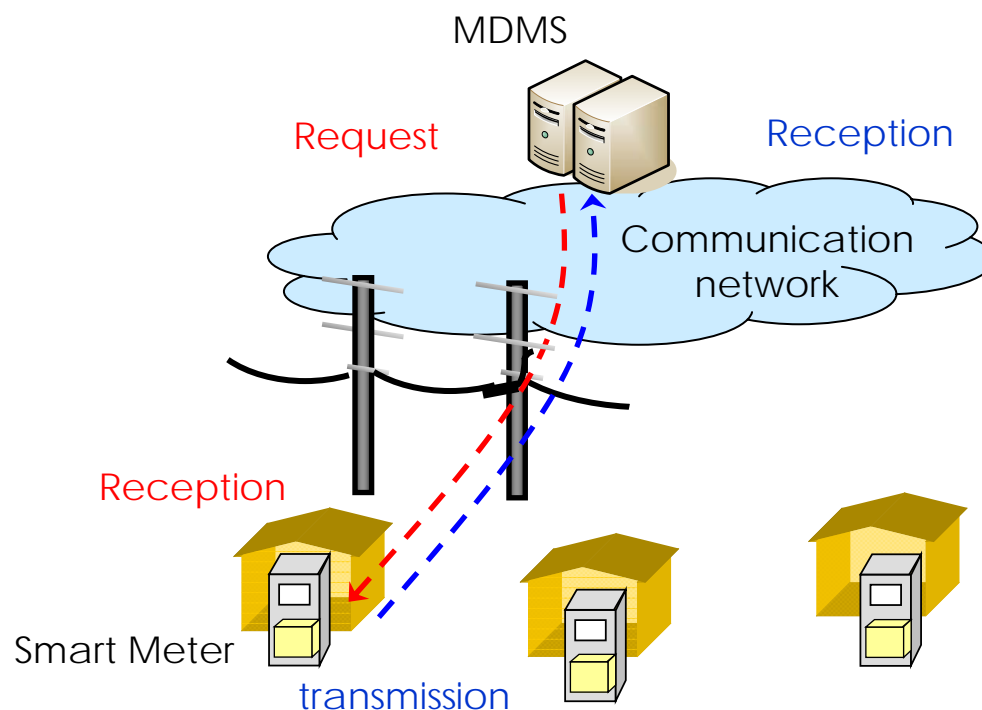

### I-3. Functions of Smart Meter (3) - Hand-held terminal communication -

- When communication via the communication network between MDMS and smart meter is not available, meter reading, setting and control can be performed directly by using hand-held terminal on site.

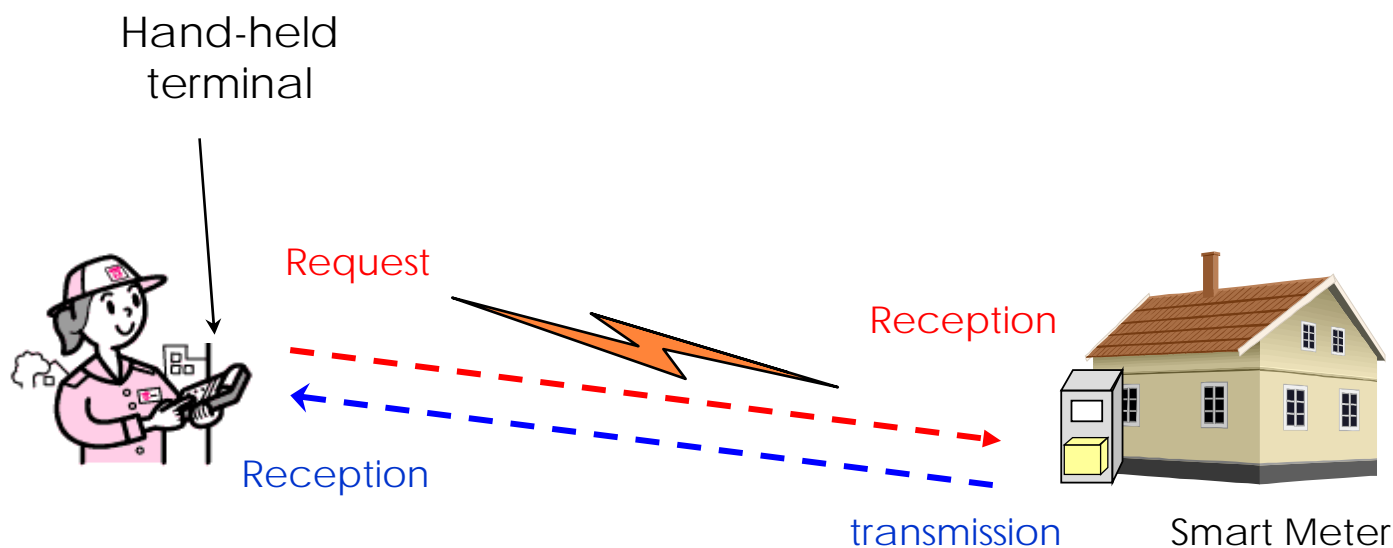

### I-3. Functions of Smart Meter (4) - Home Area network -

- In regard to the interface specifications for smart meter and HEMS (Home Energy Management System), compliance with the standardization established by the Smart House Standardization Study Group will be achieved.

#### 3. Interface between smart meter and HEMS

##### 3.1 Study result (1)

- Information, granularity and communication frequency provided by smart meters
  - Comply with ECHONET Lite for data format
  - At this point, 3 items provided are: electrical energy (30-minute value), reverse power flow (30-minute value) and time

##### 3.2 Study result (2)

- Network connection
  - Comply with IP in order to implement meters with expandability in line with the mid- and long term perspective and global standardization movement
    - ※ As for mounting IP-less units for unit implementation reasons, certain period required for IP base development is permitted but IP interconnectivity should be secured. Consider multiple utilities' smart meters to be connected.
- Communication device to be mounted for transmission with smart meter (transmission media)
  - At this point, the recommended transmission media are 920 MHz band specific low-power radio, wireless LAN and PLC

##### 3.3 Study result (3)

- Communication middleware for interfaces with smart meters
  - Communication middleware related to interface between smart meters and HEMS is complied with ECHONET Lite

~ Excerpt from the Summary by the Smart House Standardization Study Group, JSCA International Standardization WG, Press release by the Ministry of Economy, Trade and Industry (February 24, 2012)~

### I-3. Functions of Smart Meter (5) - Network Security -

■ Smart meters deal with private customer information, which require assured security measures against the threats of illegal access, leaks or alteration of information and so on.

■ Threats and countermeasures

Category	Specific Cases	Countermeasures
● Wiretapping	● Wiretapping in field area	● Encryption ● Regular updating of encryption key
● Spoofing	● Hacking	● Authentication ● Intrusion detection
● Alteration	● Altering in field area	● Packet alteration detection
● Intercepting	● Jamming of communication	● Monitor interference

### I-3. Functions of Smart Meter (6) – Operation and Maintenance -

- To manage the large-scale network efficiently and accurately, smart meter automatically transmits facility management information to MDMS.
- To effectively improve the communication software of smart meter, the communication software is remotely updated using communication network.

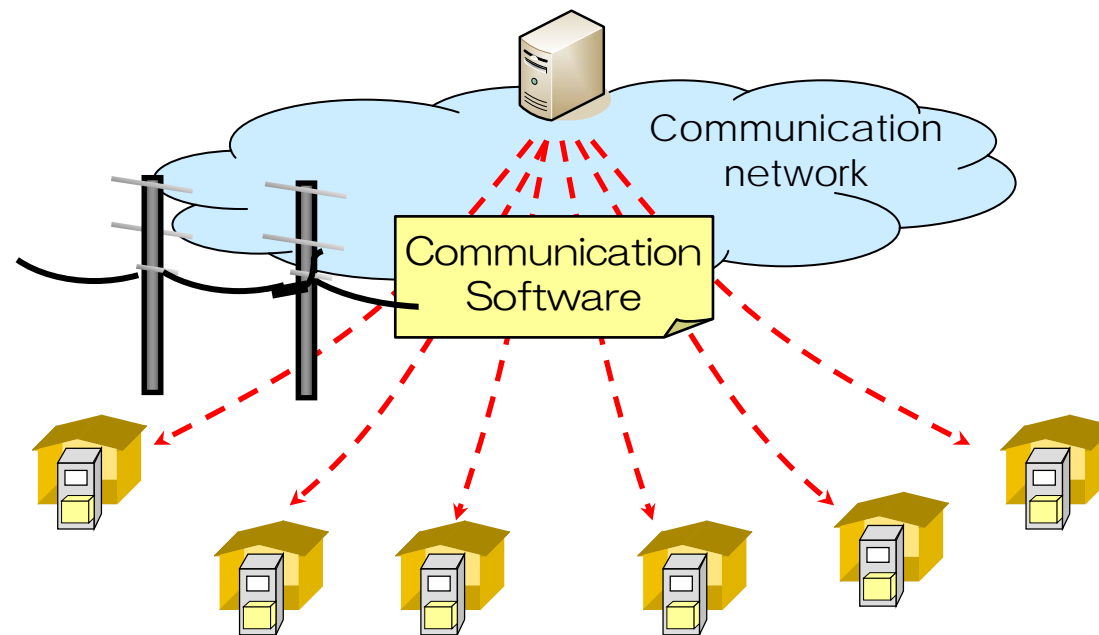

---

## I. Preconditions for Smart Meter Communication Network

## II. Concept for Selecting Communication System

1. Candidates for the Communication System
2. Features of the Communication Systems
3. Policy for Adapting the Communication System
4. Concept for Selecting Wireless Technology to Adapt RF Mesh

## III. System Overview of RF mesh Network

Chapter II describes our current concepts for selecting various kinds of communication systems. Not limited to the contents in this chapter, we sincerely welcome your wide range of comments and suggestions that could contribute to the cost reduction, quality improvement, and capability enhancement. Presenting quantitatively the advantage of your suggestion compared to our current draft will be appreciated.

### II-1. Candidates for the Communication System

---

- It is necessary to adopt a communication system suitable for local characteristics, including high-density residential areas, underground malls, high-rise apartment buildings, suburbs and mountainous areas in order to construct a communication network (FAN) that serves our 27 million customers.
  
- Using overseas introduction situation as a reference, the following three types of communication systems are potentially applicable for the smart meter communication network (FAN).
  1. RF mesh network
    - Transmits data via other wireless terminals with a bucket-brigade using a relatively low-power radio
  2. Wireless star network
    - Transmits data between a base station and wireless terminal directly using a relatively high-power radio
  3. PLC (Power Line Communications)
    - Utilizes electrical power lines as communication lines

## II-2. Features of the Communication Systems (1) - RF Mesh -

- A concentrator accommodates hundreds of smart meters.
- Constructing multiple routes between a concentrator and a smart meter can secure communication quality.
  - In case of fluctuations in RF environment (e.g., RF blocking due to vehicles or buildings) or an equipment fault, communication is ensured via alternative paths.

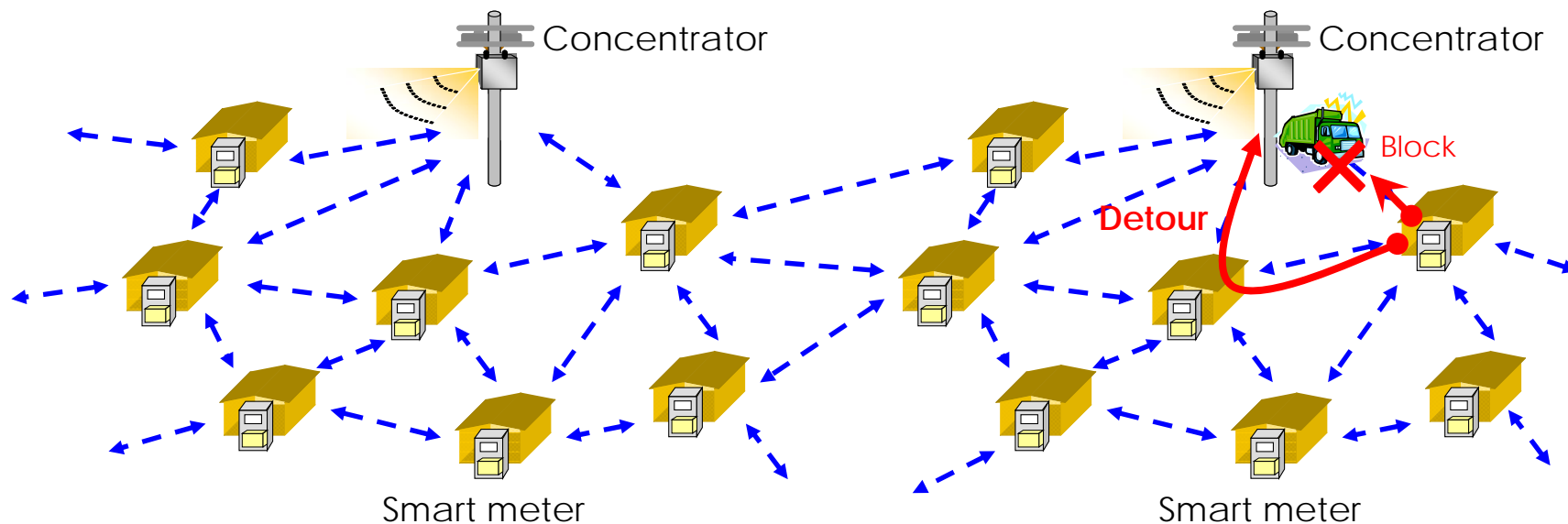

\* Concentrator: An equipment that aggregates the data of multiple smart meters



## II-2. Features of the Communication Systems (2) - Wireless Star -

- The high-power radio allows collection of smart meter data at wide area.
- This system can be used by installing an additional antenna or changing position of a smart meter when the radio from the base station cannot reach.
- Telecommunications carrier's service can be used, by considering its service quality, continuity and communication fee.

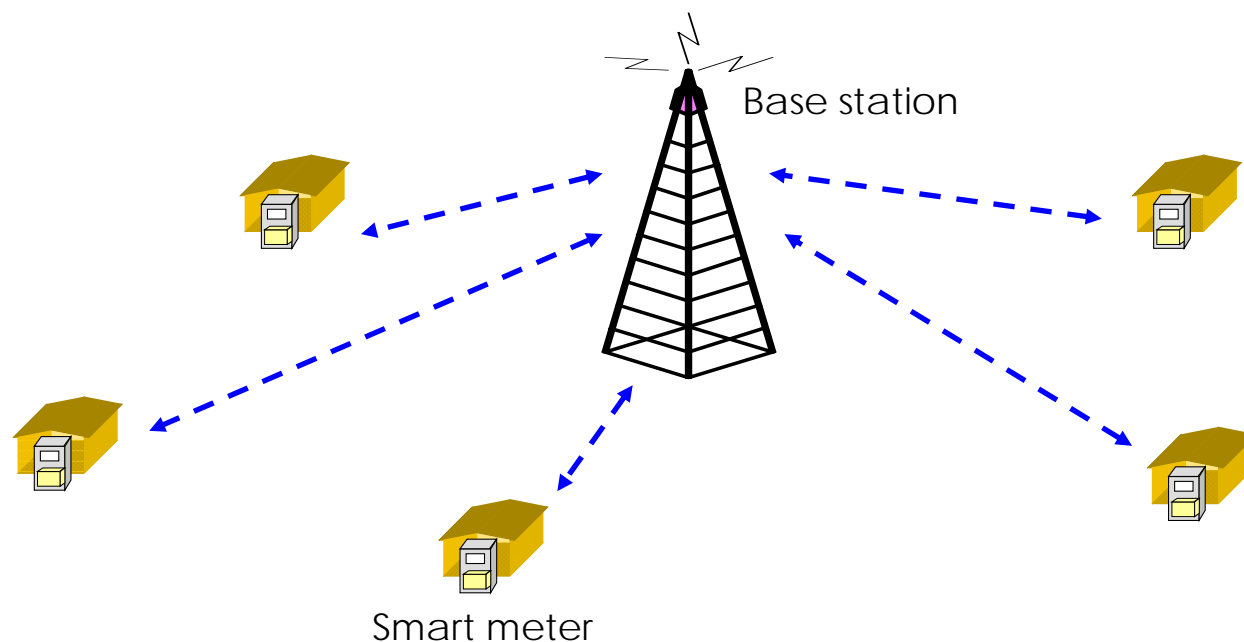

## II. Concept for Communication System Selection

### II-2. Features of the Communication Systems (3) - PLC -

- The kHz-band PLC can be used outdoors in Japan.
- A concentrator is installed for each transformer to ensure the communication quality considering transmission loss passing through transformer. (The number of customer is 10 to 20 per transformer)

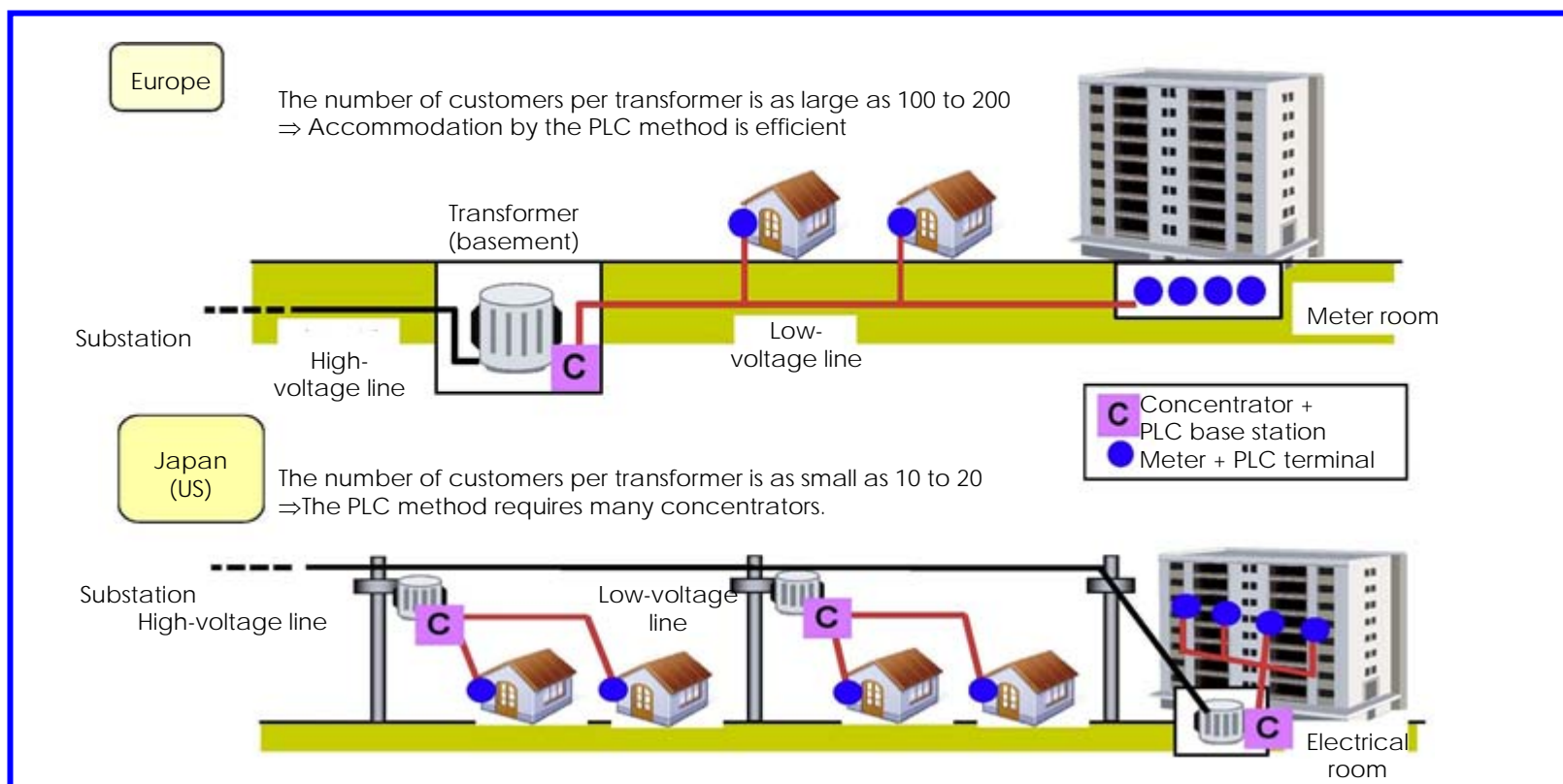

\*Source: "Trends of kHz-band power line communications and technical issues for demand-area communication networks", CRIEPI, August 2011

## II-3. Policy for adapting the Communication System

- We evaluated features of each communication method and reviewed (organized) the policy for adaptation.
- TEPCO is considering to install the following 3 systems according to the local feature. Within these systems TEPCO intends to install mainly the RF mesh system considering cost effects\*.

System	Evaluation	Adaptation policy
RF mesh	<ul style="list-style-type: none"> <li>● Investment can be suppressed by increasing smart meter aggregation efficiency with optimum concentrator layout</li> <li>● Low power consumption due to low-power radio</li> <li>● Certain user density is required for communication network construction</li> <li>● The communication between meters may not be possible depending on the installation condition of the meters (e.g. in a pipe shaft)</li> </ul>	→ Applied in common residential areas etc.
PLC	<ul style="list-style-type: none"> <li>● There is no need to set up new communication lines by using power lines</li> <li>● Applicable even where wireless transmission is difficult</li> <li>● Not suitable for wide range coverage due to its low aggregation efficiency to the concentrator</li> </ul>	→ Applied in high-rise buildings etc.
Wireless star network	<ul style="list-style-type: none"> <li>● Applying a carrier service is a precondition because constructing dedicated high-power base stations is difficult</li> <li>● Applicable area is limited to the carrier service area</li> <li>● Terminals for each carrier service are required, and communication fees are charged (Continuity of the service must be considered.)</li> </ul>	→ Applied in sparse areas such as mountainous areas etc.

\*A concentrator for RF mesh can accommodate a lot of meters, which leads to the reduction of initial cost compared to PLC. In addition, RF mesh has an advantage in running cost since it doesn't need communication fee for each meter.

- 
- I. Preconditions for Smart Meter Communication Network
  - II. Concept for Communication System Selection
  - III. System Overview of RF Mesh Network
    - 1. System Structure
    - 2. Primary Functions
    - 3. Communication Unit Overview

Chapter III describes the current system overview of RF mesh network that we are studying. Not limited to the contents in this chapter, we sincerely welcome your wide range of comments and suggestions that could contribute to the cost reduction, quality improvement, and capability enhancement. Presenting quantitatively the advantage of your suggestion compared to our current draft will be appreciated.

## III-1. System Structure

- In RF mesh networks, concentrators and hundreds of smart meters accommodated under them use the multi-hop communication mechanism for data transmission.
- The communication control server complementarily controls RF mesh networks, which are based on autonomous control, to improve the communication reliability.

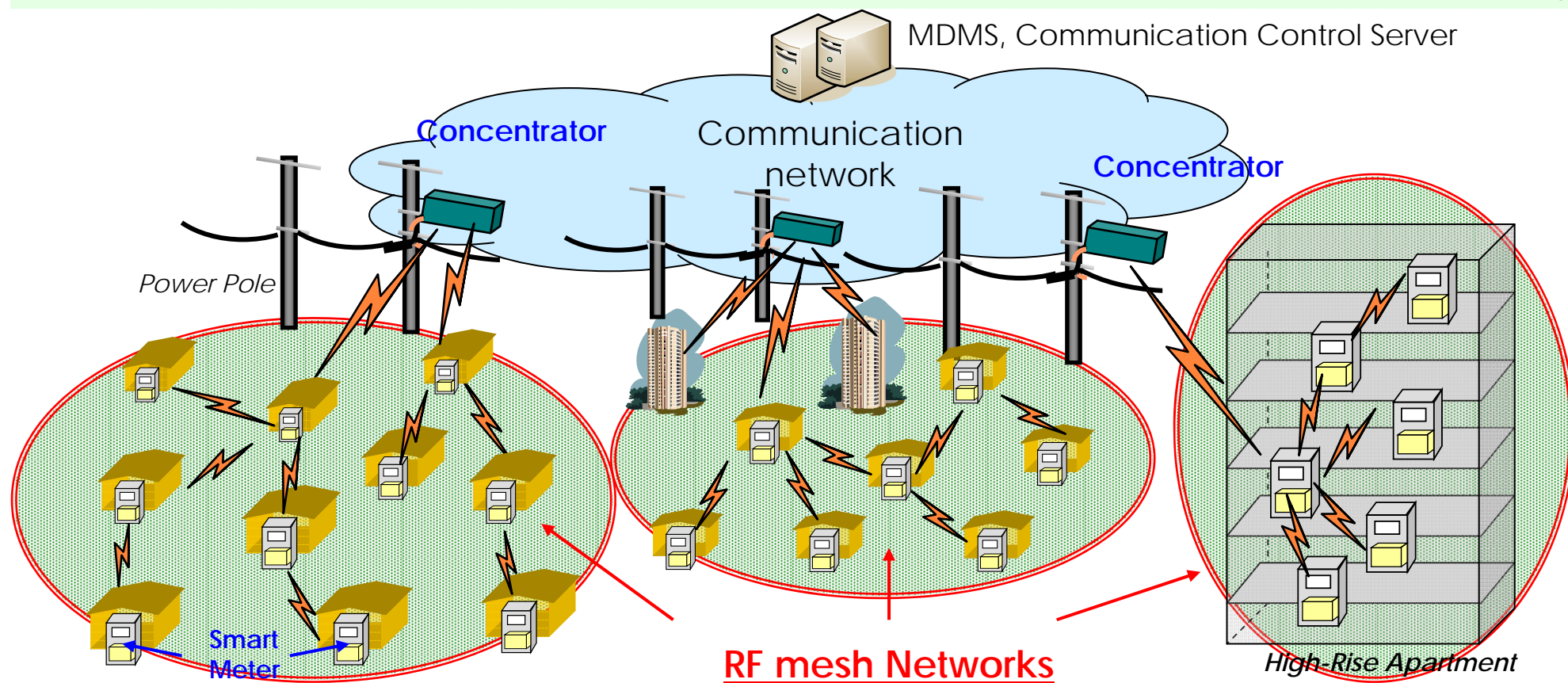

## III-2. Primary Functions (1) - Routing Control -

- The following routing control function is equipped so that the 30-minute meter reading collection, meter setting and control, and hand-held terminal communication can be realized in a stable communication quality.
  - On the basis of a tree-structured network having a concentrator at its root, the routes for "upstream," "downstream," and "P2P" are constructed depending on each property.
  - In order to respond to fluctuations in RF environment due to vehicle movement, weather conditions and so on, each communication unit autonomously structures routes. In addition, by detouring or updating the routes, data reachability is secured. The traffic for routing control is limited to a certain amount not to affect the transmission capacity.

Route Type	Property
Upstream	● Mainly for 30-minute reading collection communications. Large amount of data occurs every 30 minutes.
Downstream	● Communications from MDMS to meters. Less frequent than upstream. Mainly non-periodical communication to specific meters.
P2P	● Communication from a hand-held terminal to a meter through mesh network. Least frequent.

## III-2. Primary Functions (2) - Load Balancing -

---

- Equip with a corrective function for unbalanced communication unit occupancy of concentrators to use the wireless network efficiently.
  - When a lot of communication units are connected to a specific concentrator, congestion occurs and downgrades the communication quality.
  - In real environments, it is difficult to design the allocation free from the unbalanced occupancy, foreseeing various radio conditions.
  - Therefore, it is important to manage the number of communication unit occupancy for each concentrator so that communication units can be distributed properly.

## III-2. Primary Functions (3) - Load Limitation -

■ Equip with a function that limits the communication unit occupancy of each concentrator to prevent an overflow of communication units so that the concentrator functions normally.

- When the functions of several adjoining concentrators failed due to communication network failure or other events, the communication units accommodated by the relevant concentrator will send a connection request to a healthy neighboring concentrator all at once.
- A healthy concentrator responding to all connection requests will cause communication failure due to congestion; therefore, limiting the communication unit occupancy will ensure communication within the possible range.

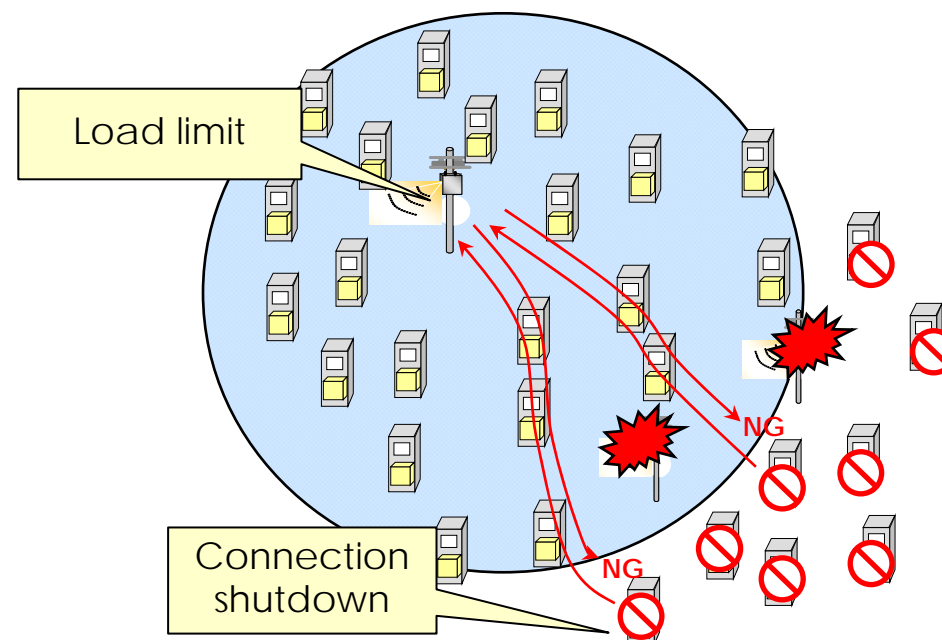



## III-2. Primary Functions (4) - Transmission Timing Dispersion -

■ Each communication unit transmits the 30-minute meter reading to the concentrator at a dispersed timing during the five minutes assigned for the transmission.

- Communication units simultaneously transmitting 30-minute meter readings cause congestion; therefore, transmission to the MDMS in near real time, the requirement of the smart meter communication network, becomes difficult.
- Each communication unit equipped with time synchronization function transmits 30-minute meter readings to concentrator at a dispersed timing.

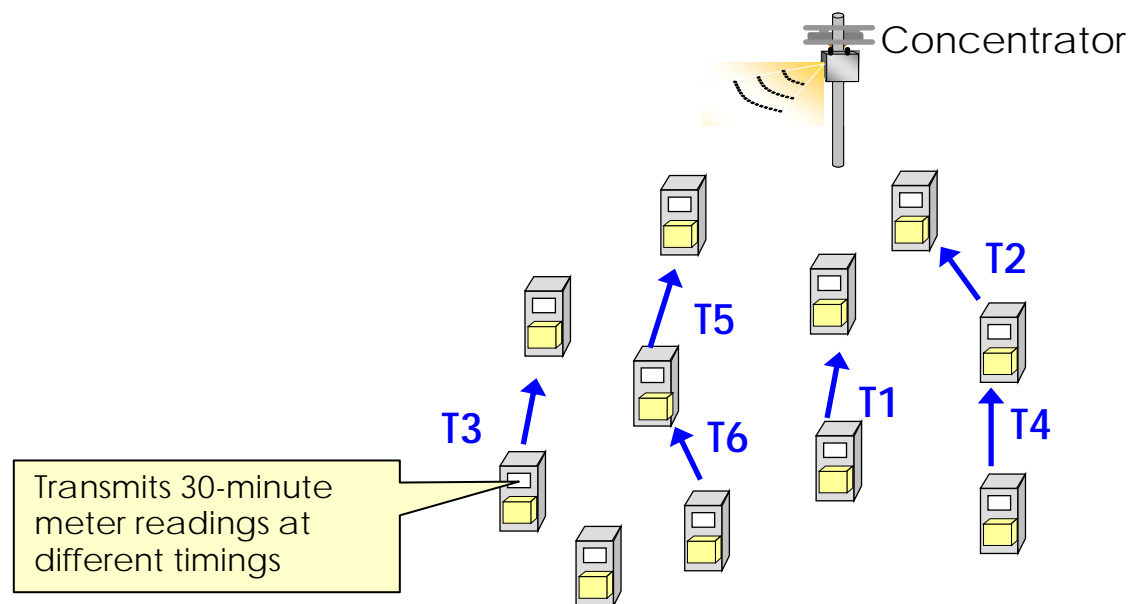

## III-2. Primary Functions (5) - Priority Processing -

- In order to avoid congestion and improve the wireless network efficiency, assign transmission time zones by type of data and transmit data on a priority basis according to the importance of the data.
- Transmit 30-minute meter readings within the five minutes assigned, and transmit recollection of lost data, network management information and others outside the five minutes.
- In order to secure real-timeliness, operator command such as meter setting and control are transmitted in priority to other data.

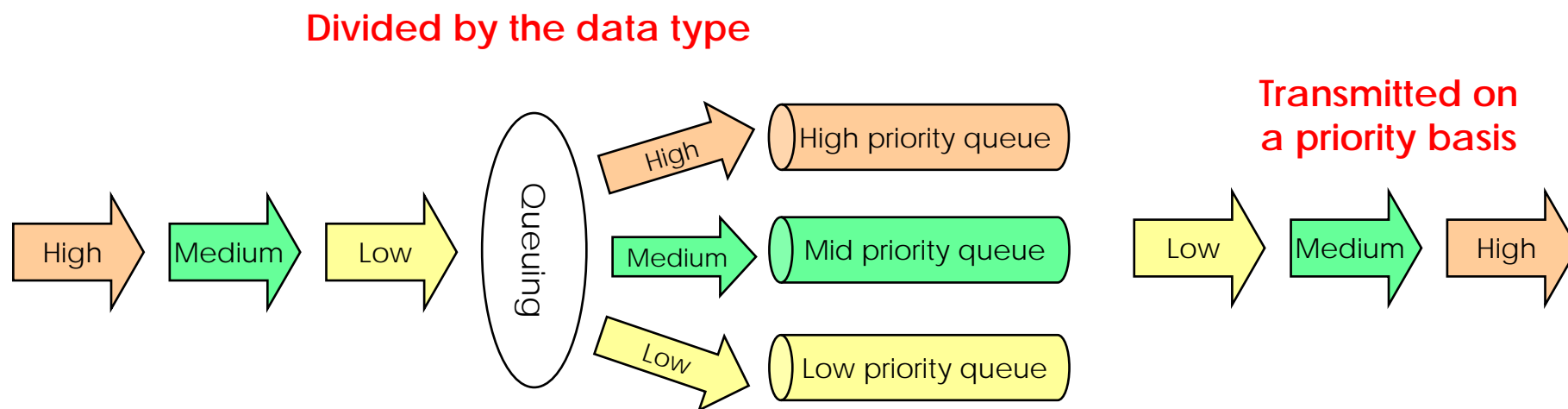

## III-2. Primary Functions (6) - Multichannel Operation -

- Equip with a multichannel operation function for securing a good wireless communication environment even in a high-density area of meter deployment.
- In high-density residential areas, multiple numbers of concentrators must be installed in proximity. When operated in the same wireless channel, radio interference or congestion may lead to a significant drop in communication quality.
- Switching the radio channels of the concentrator and communication unit will avoid radio interference and congestion.

### [Operation with single channel]

In operation at  
CH 1 (all area)

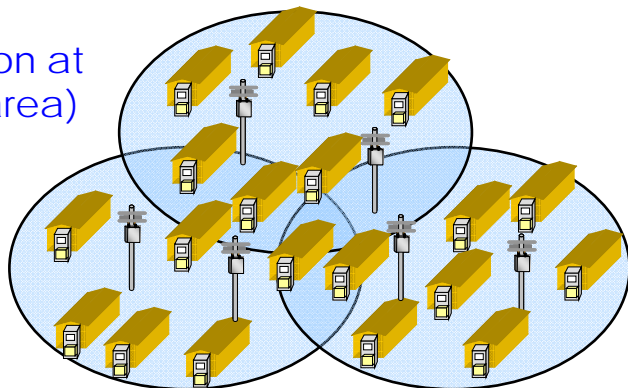

Channel  
Switching



### [Change to multichannel operation]

Operation at  
CH 2

Operation  
at CH 3

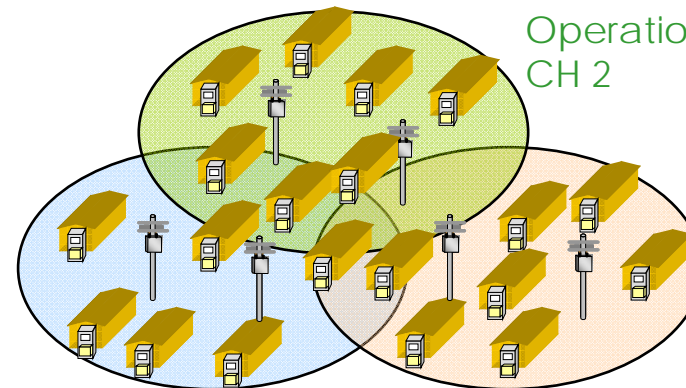

## III-2. Primary Functions (7) - Communication Software Update -

■ Equip with a function to update the communication software using RF mesh network.

- Under a limited wireless bandwidth, communication software is reliably and efficiently distributed to a large number of the communication units.
- Service continuity during communication software updates is secured by storing two software of active and inactive planes in the communication units.

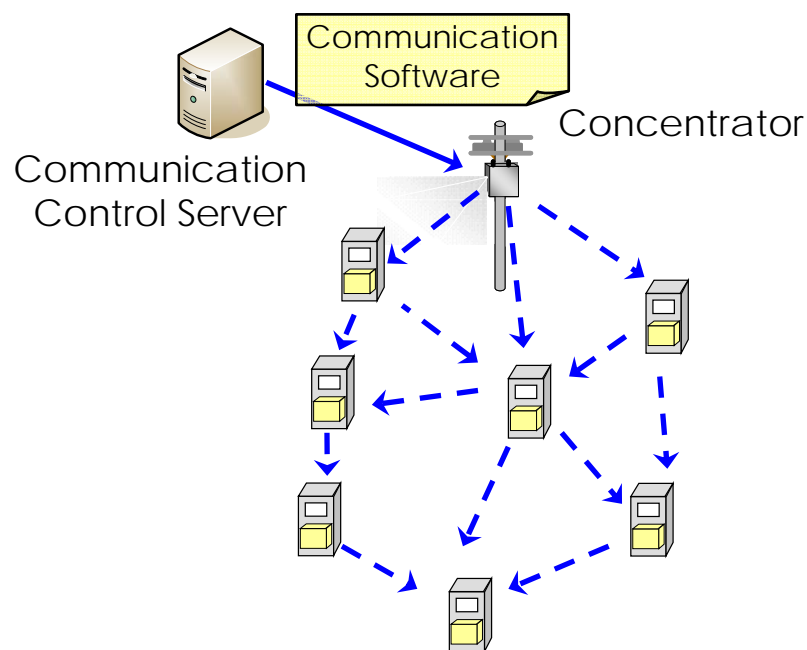

## III-2. Primary Functions (8) - Network Management -

---

■ Equip with the following functions for effective management of large scale networks

<Communication quality check function>

- Addition and removal of meters and surrounding environment changes also cause changes in wireless multi-hop network environments. The communication unit transmits the data that contributes to the evaluation and analysis of network quality on a regular basis to keep networks healthy.

<Failure management function>

- The operational status of a communication unit can be recognized with the acquisition of 30-minute meter readings. When a failure occurs, isolation of the faulty section and cause analysis are conducted based on the log information acquired and stored in the communication unit.

### III-3. Communication Unit Overview

■ The overview of the communication unit we are studying is described below.

Category	Item	Specifications
Hardware	Used frequency	- 920 MHz band (ARIB STD-T108)
	Transmission rate	- 100 kbps
	RF power	- 20 mW or less (ARIB STD-T108)
	Antenna	- Built-in antenna (diversity system)
	Frame size	- 85 mm x 78 mm x 45 mm or smaller
	Power supply	- 5 VDC, maximum 1.0 W or less (peak)
Communication protocol	Physical layer	- IEEE 802.15.4g compliant
	MAC layer	- IEEE 802.15.4e compliant
	Routing protocol (corresponds to part of LLC layer and network layer)	- Autonomous distributed routing protocol * Software without TCP/IP protocol
Others	Capacity of smart meters per concentrator	- approx. 500 units (normal) * Up to 1,000 units in a failure of a concentrator nearby
	Interconnectivity	- Secure interconnectivity between different manufacturers * Equipments are procured from multiple manufacturers for stable procurement and cost reduction

## (Reference) Exterior of Smart Meter

<External view>



<Unit structure>

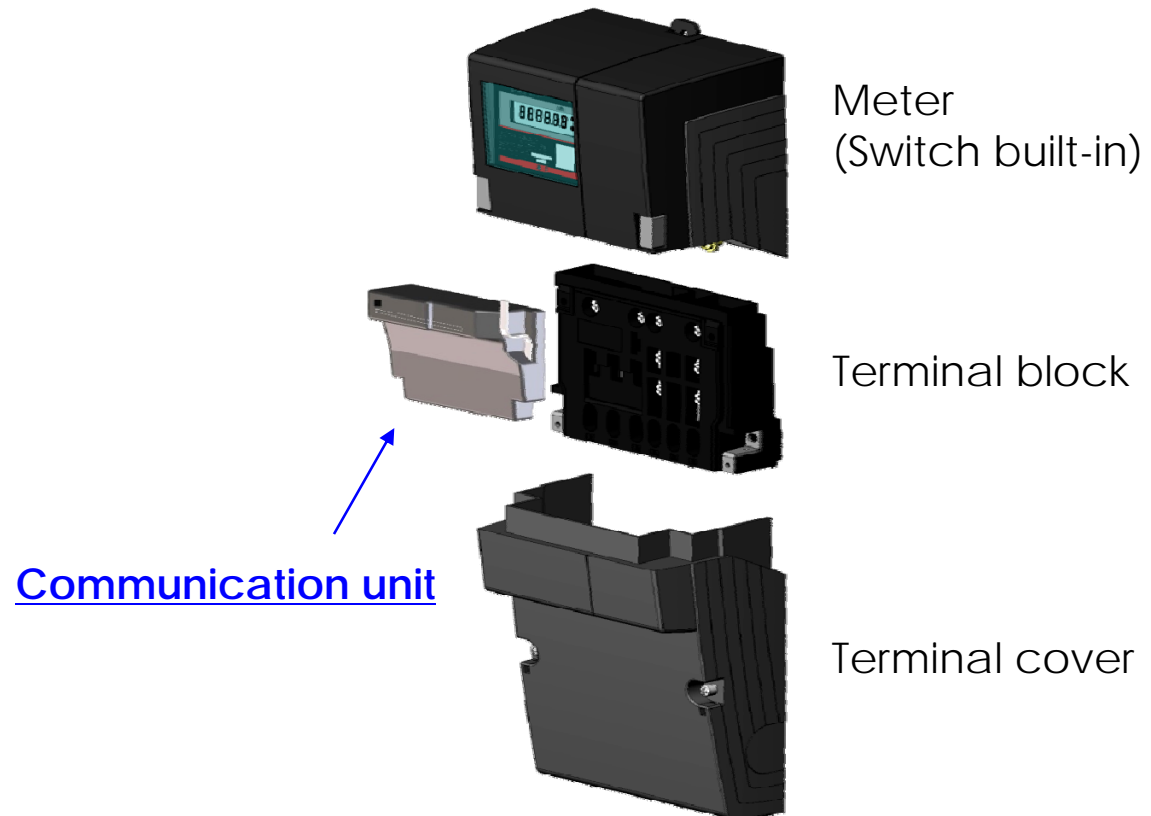

## (Reference) Schedule

- The basic specifications of metering part and communication unit will be decided in June, considering the comments and suggestions submitted within the term of RFC (March to April).
- If comparison and verification about the technical matters are necessary after the RFC of communication unit, RFP will be planned afterwards.

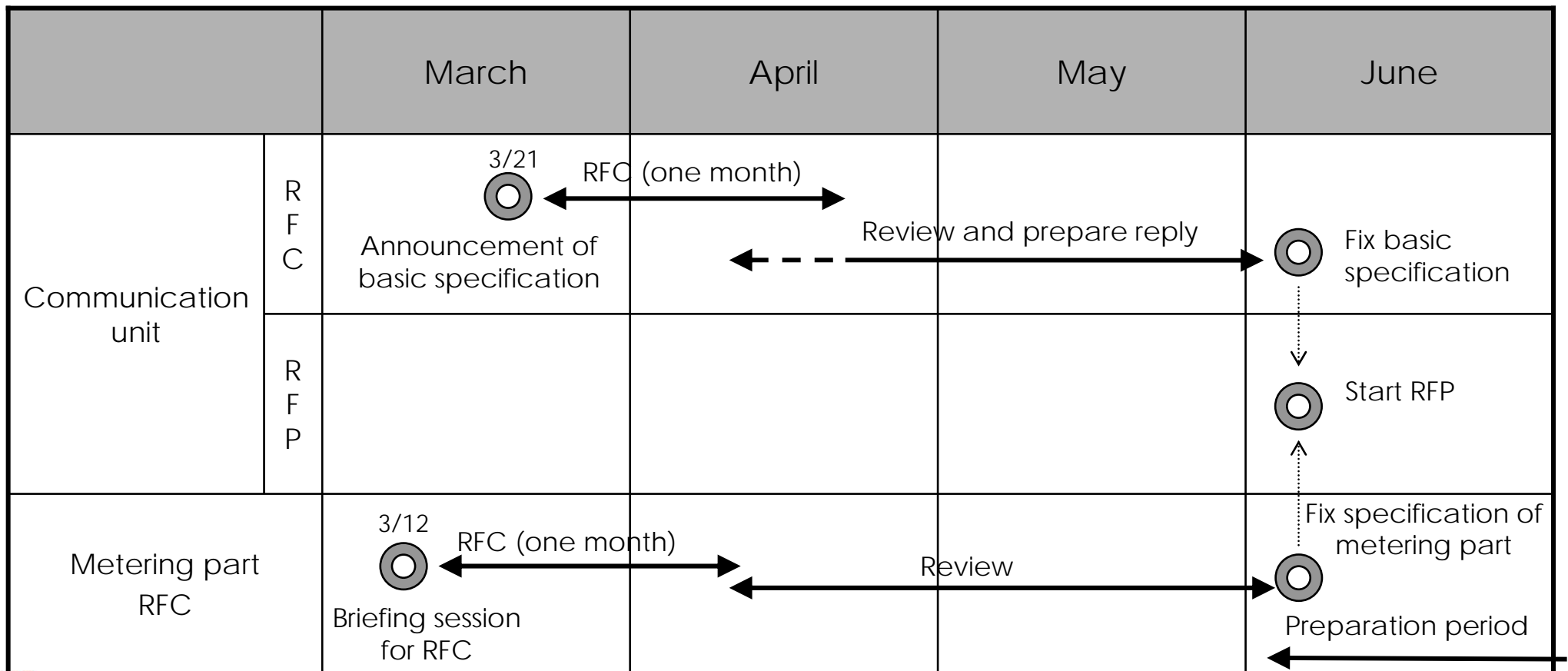



---

End