

# **Progress Status of the Groundwater Bypass Construction and Preparation for Operational Commencement**

**April 26, 2013**

**Tokyo Electric Power Company**



**東京電力**

---

# 1. Groundwater Bypass

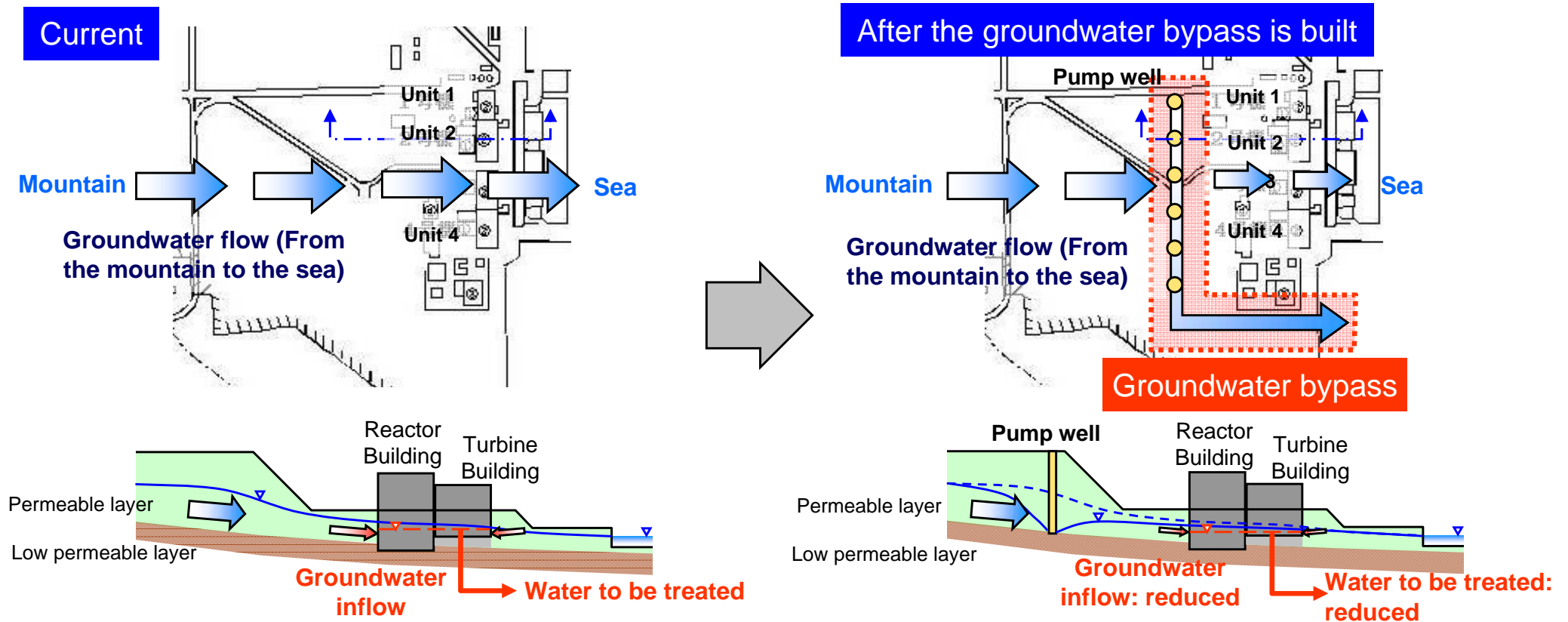

- Groundwater usually flows through the permeable layer from the mountain side to the sea side.
- Part of groundwater flows into the buildings in the process of flowing towards the sea, causing the accumulated water in the buildings to increase.
- The sub-drain is being restored in order to reduce the amount of groundwater flowing into the buildings.

- Groundwater flowing from the mountain side is pumped up in the upstream of the buildings and change the groundwater flow channel (**Groundwater bypass**)
- With the groundwater bypass, the groundwater level around the buildings (mainly in the mountain side) will be reduced and the amount of groundwater flowing into the buildings will also be reduced.
- The restoration of the sub-drain will be continued.

## 2. Construction Progress of the Groundwater Bypass

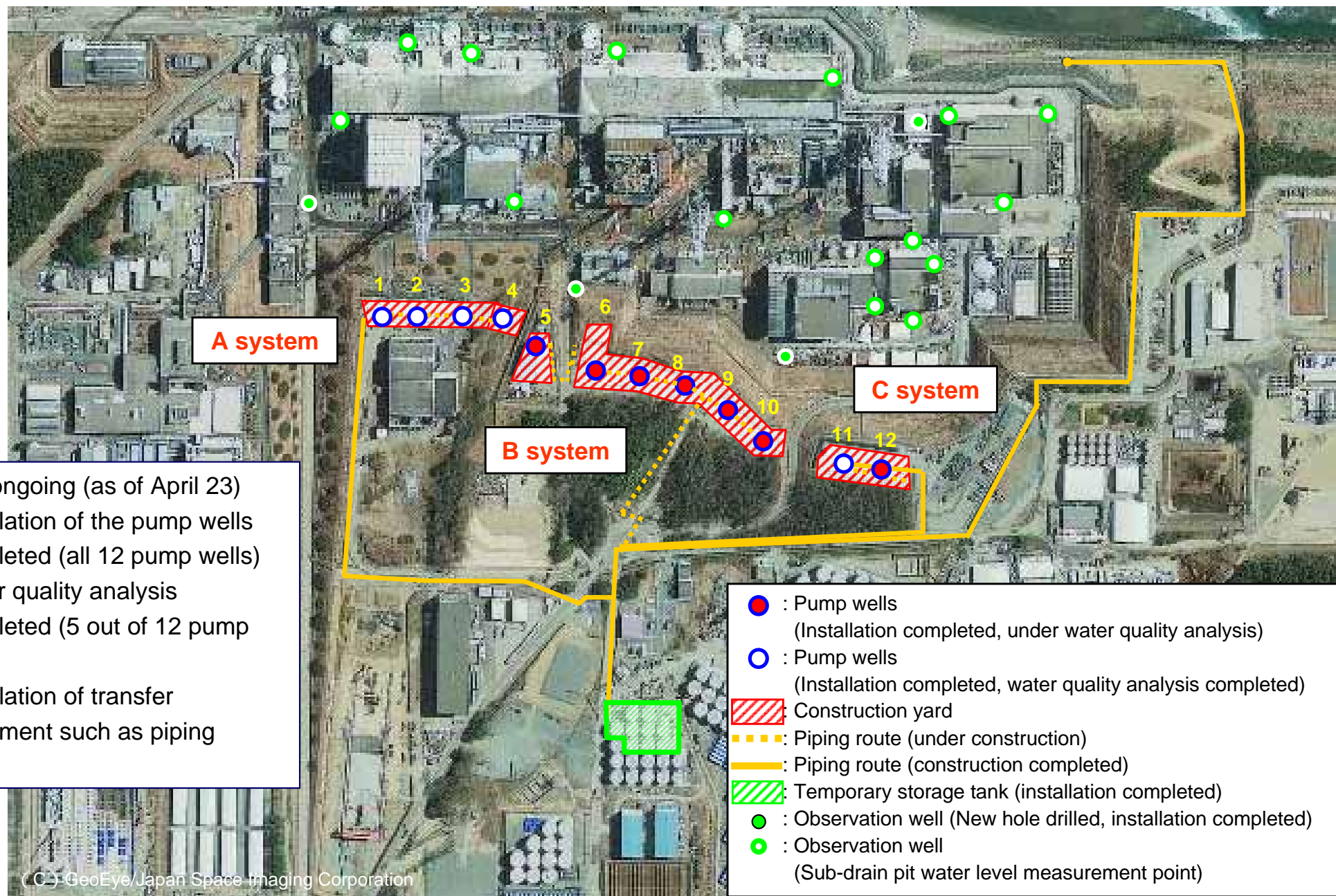

# 3. Overall Schedule

## Current status (as of April 23)

- Water pumping/transfer facility construction: The transfer pipe and the pipe around the temporary storage tanks are being installed (completed for A and C systems).
- Water pumping/transfer facility trial operation: Equipment/facility test, system test and transfer test are under implementation (completed for A system).
- Water quality test: Water quality test of A system pump well has been completed.

Work item		FY 2012				FY 2013		
		Dec.	Jan.	Feb.	Mar.	Apr.	May	Jun.-
Pump well construction			Construction		Installation completed			
				Drilling completed				
Water pumping/ transfer facility construction	A system		Construction			Trial operation, water quality test		
	B system		Construction			Trial operation, water quality test		
	C system		Construction			Trial operation, water quality test		
Groundwater bypass operation					The groundwater bypass will be put in operation upon agreement from the parties involved after water quality test is done.			

On April 22, trial operation and water quality test completed

On April 17, trial operation was started



# 4. Water Pumping/Transfer System Structure

Water is transfer from the 3 systems (A-C) to the temporary storage tanks. 9 temporary storage tanks will be installed (1Gr: 3 tanks will be used per day (3-day cycle)). The equipment is designed to allow for detailed transfer control.

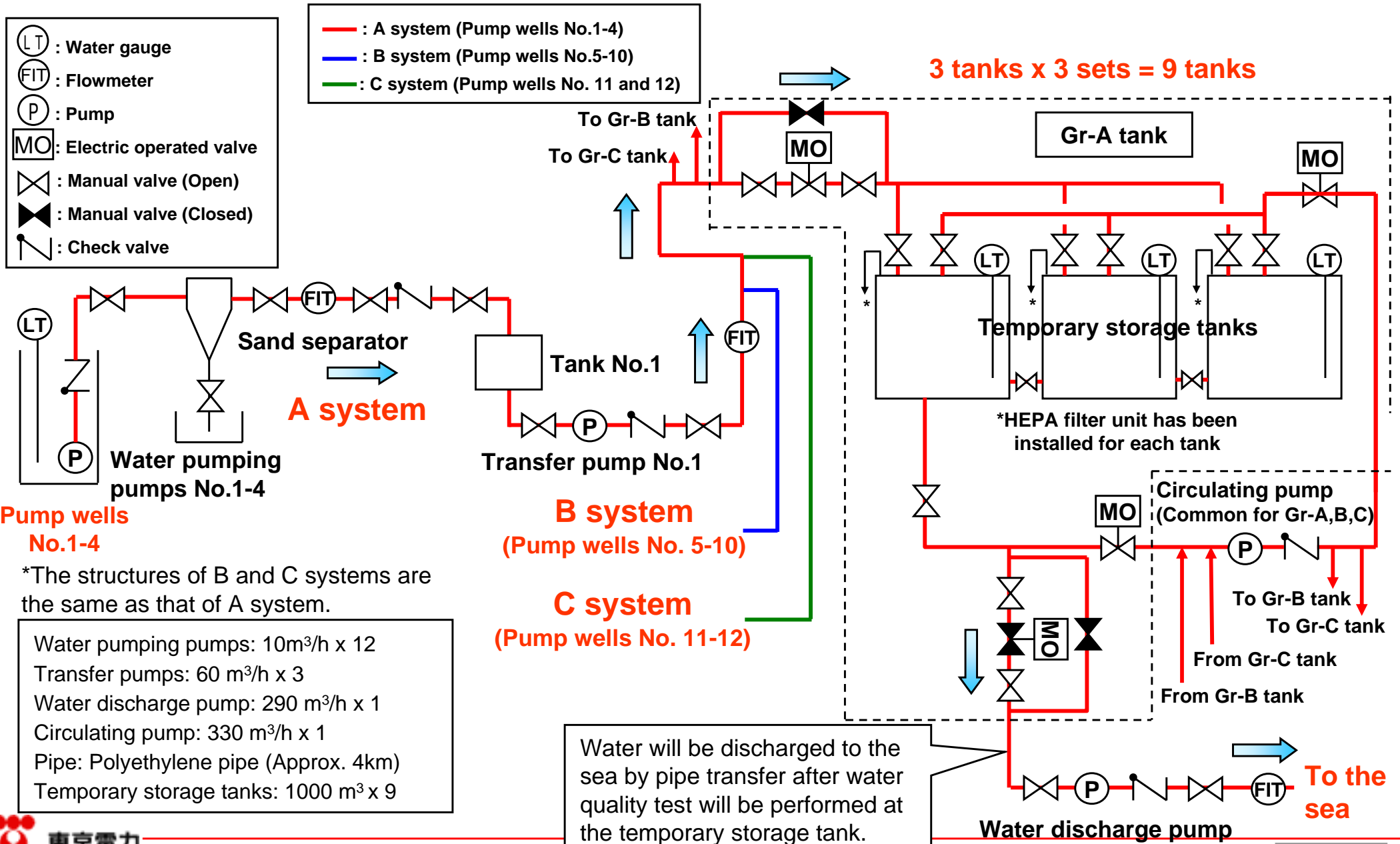

# 5. Progress of Water Pumping/Transfer Facility Trial Operation

\* As soon as all the systems are ready, equipment/facility testing, system testing and transfer testing will be conducted to confirm the function/performance, soundness, etc. in the testing lines indicated below.

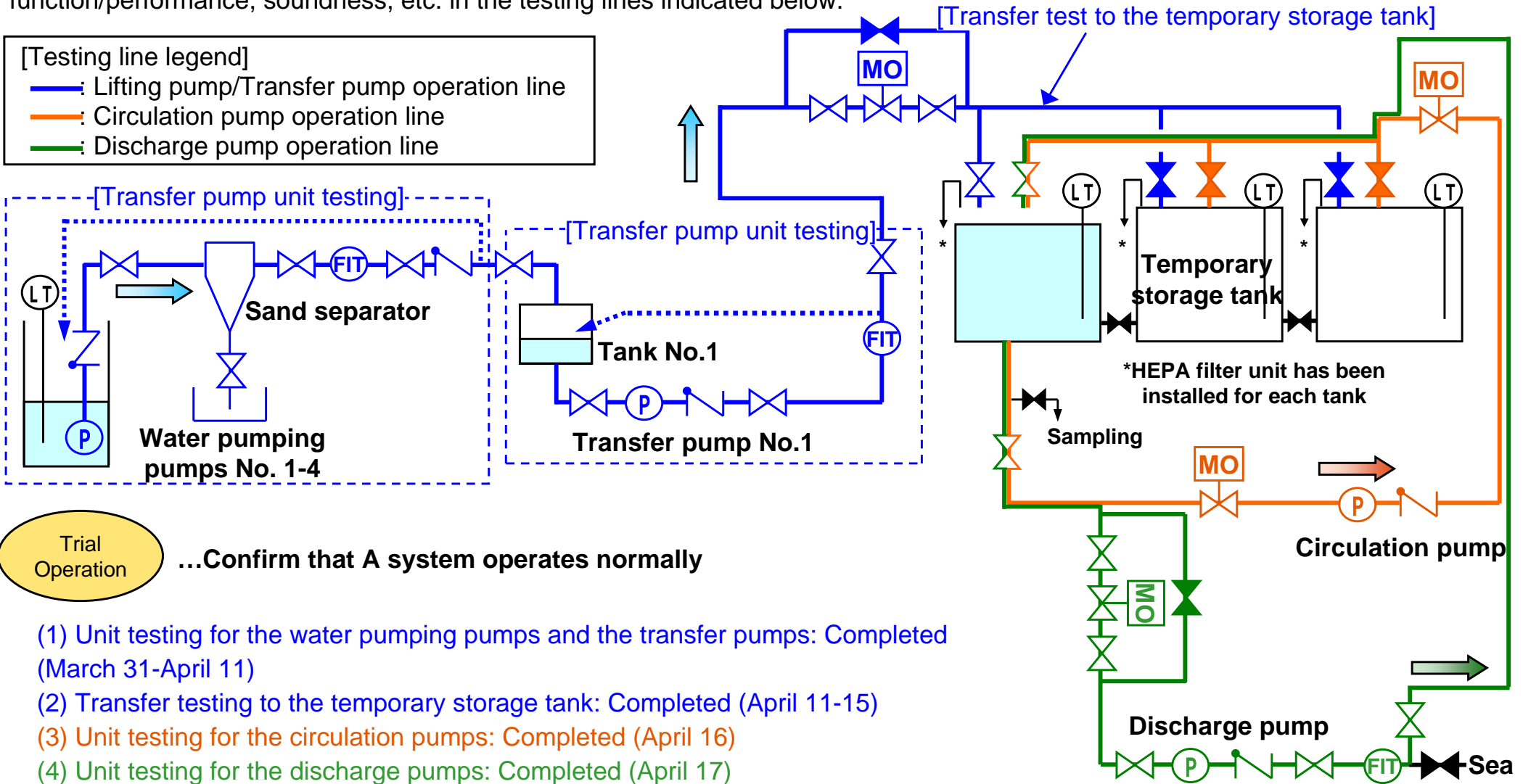

(1)(2) : Testing will be conducted separately for each system (A, B and C).  
 (3) : Testing will be conducted separately for each tank set (A, B and C)  
 (4) : Common for A, B and C systems.

## 6. Construction Progress Status (Around the Pump Wells)



Pump well No.3 and the water pumping/transfer facility



Pump well No.9 and the water pumping/transfer facility



Pump well No.11 and the water pumping/transfer facility



Pump well No.12 and the water pumping/transfer facility

# 7. Construction Progress Status (Transfer Facility and Temporary Storage Tank)

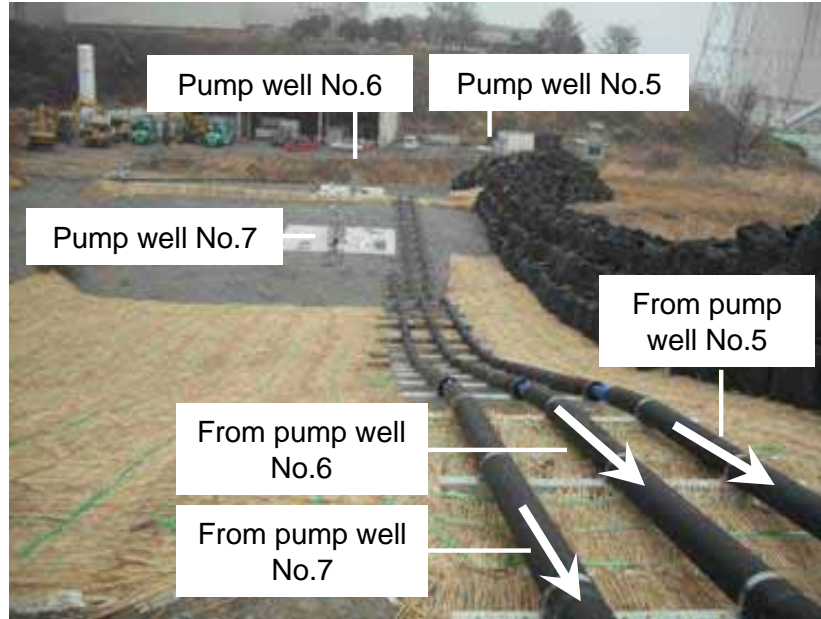

**Transfer pipes  
(B system - temporary storage tank)**

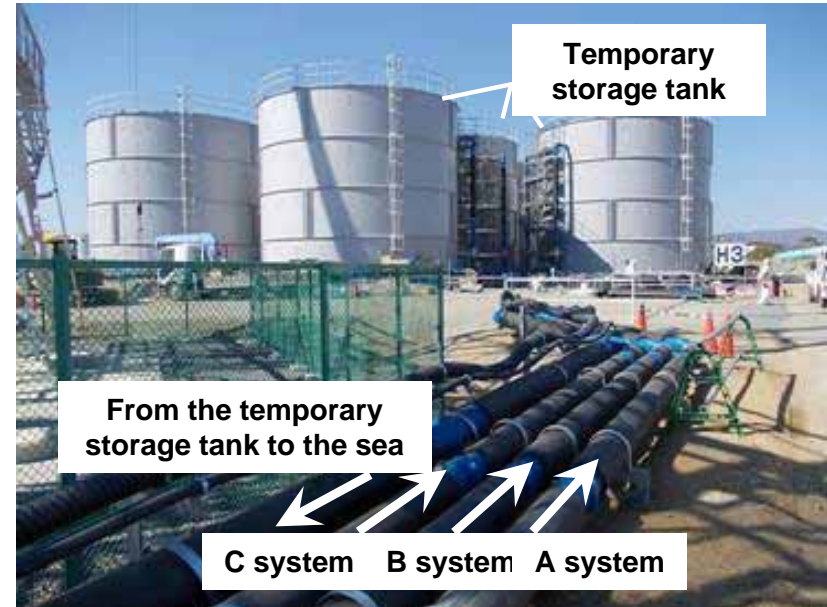

**Transfer pipes  
(Each system - temporary storage tank - sea)**



**Temporary storage tank**



**Transfer pipes  
(C system, temporary storage tank - sea)**



## 8. Progress Status of Water Quality Test (Overview)

### [Pump wells]

- From December 2012 to March 2013, water quality test of groundwater sampled from each pump well (total of 12 pump wells) was performed.
  - ✓ Water quality test for A system (pump wells No.1-4) has been completed.
  - ✓ Analysis of cesium\* and strontium is ongoing for other systems (pump wells No.5-12).
    - \* Though the cesium density was confirmed to be below the allowable limit (1Bq/L), further analysis is being performed with an increased measurement accuracy.
- The analysis results are summarized in this document and the progress will be reported together with the third party organization.
- The data of groundwater sampled from the observation holes within the site (at 3 locations) and the deep well No.3 around the site boundaries (at 1 location on the west side of the site) in the past will be used as a target for comparison.

### [Temporary storage tank]

- Water quality test will be performed after storing the groundwater pumped up from the pump wells No.1-4 in the temporary storage tank (Gr-A-1 tank).
  - ✓ Test result of cesium-137 was confirmed to be below the allowable limit (1Bq/L).
  - ✓ The radioactivity density detected this time was sufficiently lower than the densities detected in the surrounding marine area and rivers.

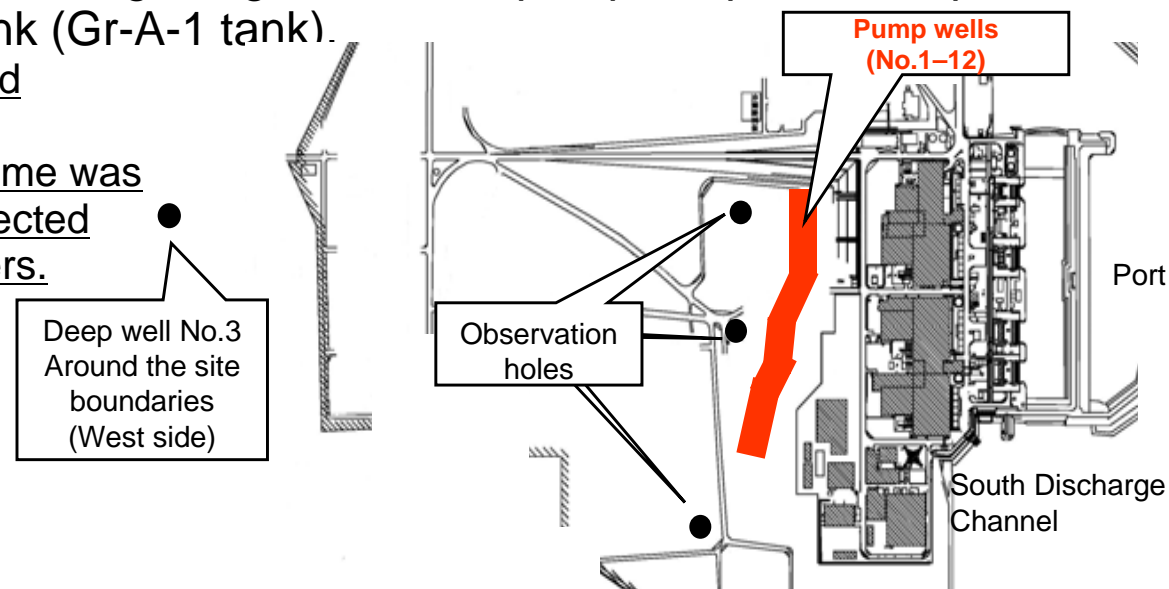

Locations of the pump wells, the observation holes and the deep well No.3

# 9. Water Quality Test Results (Progress Report) of the Pump Wells No. 1-6

- Groundwater was sampled from the pump wells (No.1-12) for water quality test performed at TEPCO and a third party organization. Water quality test for A system (No.1-4) has been completed. (Bq/L)

System Place of sampling (Sampling date) Test item	A system				B system		Density limit specified by regulation	< Reference > Observation hole and deep well No.3 at Fukushima Daiichi NPS (March - June, 2012)
	No.1	No.2	No.3	No.4	No.5	No.6		
Cesium-134	0.047 Jan. 24, 2013	0.021 Feb. 5, 2013	0.011 Dec. 11, 2012	0.060 Feb. 1, 2013	0.037 Feb. 23, 2013	(Under analysis) <sup>*1</sup>	60	ND - 0.087 (<0.0084)
Cesium-137	0.074	0.033	0.012	0.12	0.076	(Under analysis) <sup>*1</sup>	90	ND - 0.13 (<0.0088)
Strontium-89	ND (<0.079)	ND (<0.059)	ND (<0.236)	ND (<0.065)	(Under analysis)	ND (<0.048)	300	ND (<0.017 - 0.046)
Strontium-90	ND (<0.024)	ND (<0.021)	ND (<0.068)	ND (<0.022)	(Under analysis)	ND (<0.018)	30	ND (<0.0067 - 0.0072)
Tritium	9	15	10	39	22	60	60,000	7 - 184
All	ND (<1.7)	ND (<1.7)	ND (<1.0)	ND (<1.7)	ND (<2.2)	ND (<2.0)	-	ND (<2.8 - 3.0)
All	ND (<2.7)	ND (<6.6)	ND (<2.7)	ND (<6.5)	ND (<6.5)	ND (<6.5)	-	ND (<5.9 - 6.7)

- ND: Below the detection limit (provided in the parenthesis).
- This chart indicates data analyzed by TEPCO.

<sup>\*1</sup> The cesium density of the groundwater in each pump well was confirmed to be below the allowable limit (1Bq/L). Further analysis is ongoing at present.

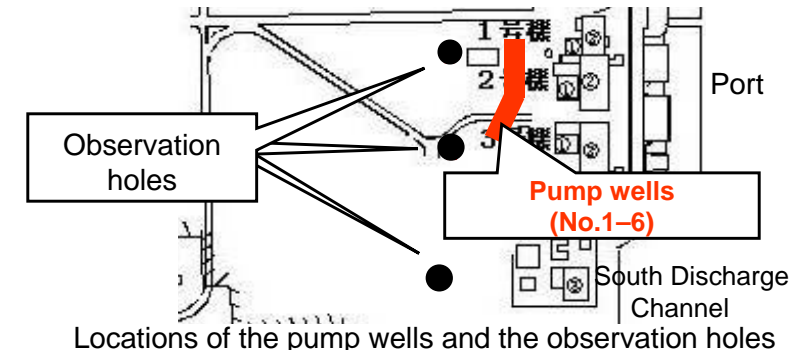

<sup>\*1</sup>The observation holes are located at approx. O.P.+35m above sea level.

# 9. Water Quality Test Results (Progress Report) of the Pump Wells No. 7-12

(Bq/L)

Test item	System	B system				C system		Density limit specified by regulation	< Reference > Observation hole and deep well No.3 at Fukushima Daiichi NPS (March - June, 2012)
	Place of sampling (Sampling date)	No.7	No.8	No.9	No.10	No.11	No.12		
		Mar. 1, 2013	Mar. 13, 2013	Mar. 4, 2013	Mar. 11, 2013	Feb. 12, 2013	Feb. 16, 2013		
Cesium-134		ND (<0.014)	0.024	ND (<0.013)	0.029	ND (<0.013)	0.036	60	ND - 0.087 (<0.0084)
Cesium-137		ND (<0.016)	0.048	0.030	0.056	0.023	0.061	90	ND - 0.13 (<0.0088)
Strontium-89		(Under analysis)	(Under analysis)	(Under analysis)	(Under analysis)	ND (<0.055)	ND (<0.056)	300	ND (<0.017 - 0.046)
Strontium-90		(Under analysis)	(Under analysis)	(Under analysis)	(Under analysis)	ND (<0.019)	ND (<0.020)	30	ND (<0.0067 - 0.0072)
Tritium		30	20	13	76	57	450	60,000	7 - 184
All		ND (<2.2)	ND (<1.7)	ND (<2.2)	ND (<2.6)	ND (<1.7)	ND (<1.7)	-	ND (<2.8 - 3.0)
All		ND (<6.7)	ND (<6.4)	ND (<6.6)	ND (<6.5)	ND (<2.6)	ND (<2.6)	-	ND (<5.9 - 6.7)

- ND: Below the detection limit (provided in the parenthesis).
- This chart indicates data analyzed by TEPCO.

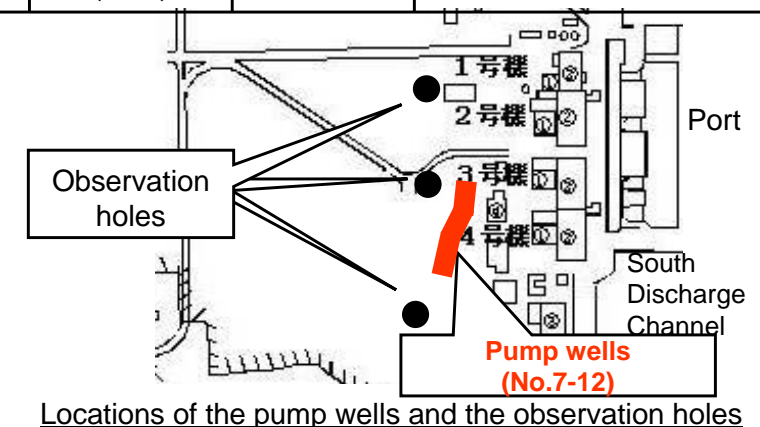

Locations of the pump wells and the observation holes

\* The observation holes are located at approx. O.P.+35m above sea level.

# 10. Water Quality Test Results (Progress Report) of the Pump Wells [Analyzed by a Third Party Organization]

(Bq/L)

System Place of sampling Test item	A system				B system	
	No.1	No.2	No.3	No.4	No.5	No.6
Cesium-134	ND (<0.0074)	ND (<0.0087)	ND (<0.01)	0.015	ND (<0.0089)	ND (<0.0084)
Cesium-137	ND (<0.0075)	ND (<0.0077)	ND (<0.01)	0.037	ND (<0.0069)	ND (<0.0080)
Strontium-89	ND (<0.013)	ND (<0.012)	*1	ND (<0.012)	(Under analysis)	ND (<0.018)
Strontium-90	ND (<0.005)	ND (<0.005)	ND (<0.005)	ND (<0.005)	(Under analysis)	ND (<0.006)
Tritium	2	3	ND (<3.7)	6	12	48
All	ND (<1.8)	ND (<1.8)	ND (<0.1)	ND (<1.8)	ND (<1.5)	ND (<1.8)
All	ND (<4)	ND (<4)	ND (<0.2)	ND (<4)	ND (<3.9)	ND (<3.9)

System Place of sampling Test item	B system				C system	
	No.7	No.8	No.9	No.10	No.11	No.12
Cesium-134	ND (<0.0075)	ND (<0.0089)	ND (<0.0087)	ND (<0.0075)	0.0088	ND (<0.0087)
Cesium-137	ND (<0.0066)	ND (<0.0077)	ND (<0.0080)	0.011	0.016	ND (<0.0079)
Strontium-89	ND (<0.015)	(Under analysis)	ND (<0.012)	(Under analysis)	ND (<0.011)	(Under analysis)
Strontium-90	ND (<0.005)	(Under analysis)	ND (<0.005)	(Under analysis)	ND (<0.005)	(Under analysis)
Tritium	17	15	3	71	49	440
All	ND (<1.8)	ND (<1.5)	ND (<1.8)	ND (<1.5)	ND (<1.8)	ND (<1.5)
All	ND (<3.9)	ND (<3.9)	ND (<3.9)	ND (<3.9)	ND (<4)	ND (<3.9)

- ND: Below the detection limit (provided in the parenthesis).

- This chart indicates data analyzed by a third party organization.

\*1 As for the radioactive strontium, only strontium-90 was analyzed.



# 11. Summary of Analysis Results of the Pump Wells

---

■ The following is the summary of analysis results collected so far at A system pump wells No.1-4.

## ■ Cesium

- As a result of analysis after improving the measurement accuracy, an extremely small amount of cesium was detected (0.012 - 0.12 Bq/L) in the pump wells No.1-4 though the density was below the allowable limit (1Bq/L).
- The density was substantially lower than that of the samples collected in the river near the power station after the accident from April 2012 to March 2013 (approx. 1-2Bq/L) and was equivalent to that of the observation holes in the site and the deep well No.3 located near the site boundary in the west side.
- The density was less than one-several thousandths of the limit specified by the Reactor Regulation (Cesium-137: 90Bq/L).

## ■ Tritium

- The tritium densities detected in the pump wells No.1-4 were 9-39 Bq/L.
- Though the tritium densities detected in all the pump wells (including No.1-4) were 9-450 Bq/L, the densities were less than one hundredths or one several thousandths of the limit specified by the Reactor Regulation (60,000 Bq/L).
- The densities of the sample collected in the observation holes in the site and the deep well No.3\* located near the site boundary from March to June 2012 were approx. 7-184 Bq/L.  
(\*9 Bq/L in May 2012)

## ■ Strontium, all, all

- The densities in all the pump wells including No.1-4 were below the detection limits.

## 12. Water Quality Test Before the Operational Commencement

Before the operational commencement, groundwater will be stored in the temporary storage tanks and the following water quality test will be performed on the groundwater sampled from all the pump wells in order to confirm that the cesium-137 density is 1Bq/L or less (the maximum cesium density limit for water to be discharged) that the density is sufficiently lower than the densities detected in the surrounding marine area and rivers.

	Monitoring before the operational commencement of the groundwater bypass
Purpose	Determine the feasibility of operational commencement
Location	Temporary storage tank
Items to check*1	1. Whether cesium-137 density is 1Bq/L or less (maximum allowed density) 2. Whether the density is sufficiently lower than that of samples collected in the surrounding marine area and rivers (representative nuclide: cesium-137)
Analysis items*2 (Detection limit*3)	Cesium-137 (0.01Bq/L) Tritium (3Bq/L) All (4Bq/L) All (7Bq/L)

\*1 Each tank to be checked before the first operational commencement.

\*2 Strontium-90 will be checked after the operational commencement.

\*3 The detection limit may vary depending on the measurement environment, etc.

# 13. Water Quality Test Results of the Temporary Storage Tanks (Before the Operational Commencement)

- After the water quality test was completed for the pump wells No.1-4, the groundwater was pumped up from the pump wells No.1-4 to the temporary storage tank (Gr-A-1 tank) for water quality test.
- The water quality test results of Gr-A-1 tank are as below.
  - (1) The cesium-137 density was confirmed to be below the allowable limit (1Bq/L).
  - (2) The cesium density was sufficiently lower than the densities detected in the surrounding marine area and rivers (Cesium-137 density [representative nuclide]: 1-2Bq/L).
- Even if the water in Gr-A-1 tank is directly taken into human body orally, the impact on human body is considered to be fairly low (similarly to the groundwater in the pump wells).

(Bq/L)

System Date of sampling	Temporary storage tank (Gr-A-1 tank)		<Reference> Pump wells (A system) [Previously announced]				Density limit specified by regulation	< Reference > Observation hole and deep well No.3 at Fukushima Daiichi NPS (March - June, 2012)
	April 16, 2013		No.1	No.2	No.3	No.4		
Test item	April 16, 2013		Jan 24, 2013	Feb 5, 2013	Dec 11, 2012	Feb 1, 2013		
Purpose of the analysis	(1) Comparison to the maximum allowed density	(2) Detailed analysis	Detailed analysis (water quality test of the groundwater will be performed before the operational commencement)				-	-
Cesium-134	ND (<0.42)	ND (<0.042)	0.047	0.021	0.011	0.060	60	ND - 0.087 (<0.0084)
Cesium-137	ND (<0.59)	ND (<0.059)	0.074	0.033	0.012	0.12	90	ND - 0.13 (<0.0088)
Tritium		21	9	15	10	39	60,000	7 - 184
All		ND (<3.0)	ND (<1.7)	ND (<1.7)	ND (<1.0)	ND (<1.7)	-	ND (<2.8 - 3.0)
All		ND (<6.3)	ND (<2.7)	ND (<6.6)	ND (<2.7)	ND (<6.5)	-	ND (<5.9 - 6.7)

 東京電力 - ND: Below the detection limit (provided in the parenthesis)

# 14. Water Quality Test After the Operational Commencement (Draft)

1. The maximum allowed cesium-137 density of the water to be discharged is **1Bq/L** taking into considerations the regulation values, detection limits of public water, etc.
2. Besides from the above, detailed analysis will be performed on a regular basis (about once every 3 months (once a month for the first 3 months)) to monitor changes over a long period of time. (Data check will be performed at a third party organization as well.)

	Monitoring after the operational commencement of the groundwater bypass	
Purpose	Determine the feasibility of water discharge	Monitor density fluctuations in a long period of time
Frequency	Timing of water discharge (Monitoring to be done beforehand)	On a regular basis (About once every 3 months (once a month during the first 3 months)) - Mix the samples obtained in 3 months (composite sample) for analysis
Location	Temporary storage tank	Temporary storage tank
Item to check	Whether cesium-137 is <b>1Bq/L or less (maximum allowed density)</b>	Whether the density is sufficiently lower than that of the samples collected in the surrounding marine area and rivers (representative nuclide: cesium-137) [Detailed analysis]
Analysis items (Detection limit)	Cesium-137 (1Bq/L or less)	Cesium-137 (0.01Bq/L) Strontium-90 (0.01Bq/L) Tritium (3Bq/L) All (4Bq/L) All (7Bq/L)

## [Reference] Examples of regulation values of radioactive cesium density

(Drinking water) Cesium-134 + cesium-137 10Bq/L

(Fish and shellfish) Cesium-134 + cesium-137 100Bq/kg

(Density limit specified by the Reactor Regulation) Cesium-134: 60Bq/L, cesium-137:90Bq/L

(Investigation performed by the Ministry of the Environment\*) Detection limit of cesium-134 and 137: 1Bq/L





# 15. Operation Method

## Basic Policy

The pumped up ground water is temporarily stored in the tank for water quality test (to confirm that its radioactivity density is below the maximum allowed limit) before being transferred to the sea.

## Operational cycle

	Day 1	Day 2	Day 3
1. Storage	Stop storage		Start storage after transfer is complete
2. Water quality test	Sample water	Water quality analysis	
3. Discharge			Transfer

Confirm that the radioactivity density is below the maximum allowed limit.

## 3 sets x 3 days cycle

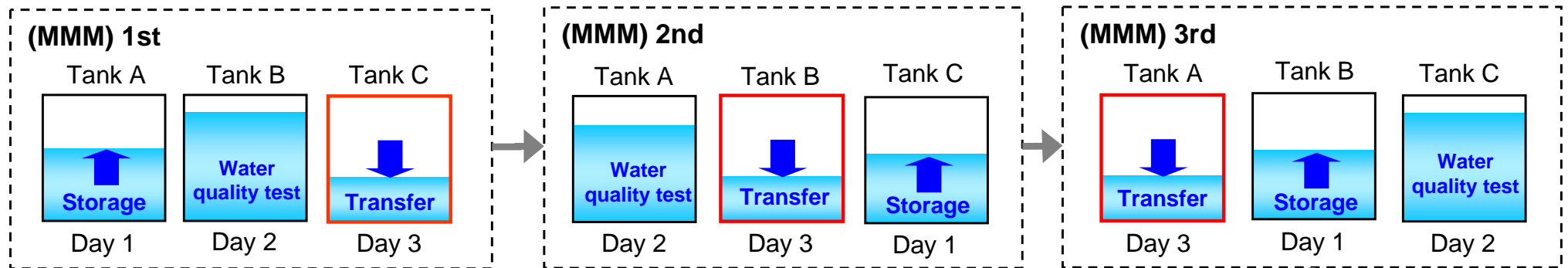

The process is repeated and the water quality is confirmed before being transferred to the sea.

# 16. Future Plans

---

The groundwater bypass will be put in operation starting from A system (pump wells No.1-4) upon agreement from the parties involved after the water quality test results are reported.

The progress of preparation towards the operational commencement is as follows.

➤A system (Pump wells No.1-4)

- The water quality analysis for pump wells No.1-4 has been completed (including the analysis performed by a third party organization)
- The water quality test before the trial operation and the operational commencement has been completed.

➤B system (Pump wells No.5-10)

- The water quality analysis for pump wells No.5-10 will be completed in mid May (including the analysis performed by a third party organization)
- The water quality test before the trial operation and the operational commencement will be completed in late May.

➤C system (Pump wells No.11 and 12)

- The water quality analysis for pump wells No.11 and 12 will be completed in late April (including the analysis performed by a third party organization)
- The water quality test before the trial operation and the operational commencement will be completed in mid May.

\*The water quality test results after the operational commencement will be announced on our web page, etc. as necessary.

# [Reference] Comparison to Various Standard Values

(Bq/L)

Nuclide	Cesium-137	Strontium-90	Tritium
Pump well (Maximum)	0.12	ND(<0.068)	450
WHO guidelines for drinking water quality	10	10	10,000
Density limit specified by regulation	90	30	60,000
Radioactive materials in food (Drinking water)	10*	-	-
Guidelines for radioactive materials in the bathing area	10*	-	-

\*Total density of Cs-134 and Cs-137

# [Reference] Water Quality Test Results of the Rivers Around the Power Station (After the Accident)

Sampling location		Density (Bq/L)	
		Cesium-134	Cesium-137
Ota River	Minamisoma City	ND (<1) - 1	ND (<1) - 2
Maeda River	Futaba Town	ND (<1) - 1	ND (<1) - 1
	Namie Town	ND (<1) - 1	ND (<1) - 1
Ukedo River	Namie Town	ND (<1)	ND (<1) - 1
Kuma River	Okuma Town	ND (<1)	ND (<1)
Tomioka River	Tomioka Town	ND (<1)	ND (<1)
Kido River	Kawauchi Village	ND (<1)	ND (<1)
	Naraha Town	ND (<1)	ND (<1)

\* The detection limit of cesium-134 and cesium-137 used in the investigation performed by the Ministry of the Environment is 1Bq/L.

\* Source: “Radioactive material monitoring results of the public water in Fukushima Prefecture (Sampled in April-June)” (announced on July 31, 2012), “Radioactive material monitoring results of the public water in Fukushima Prefecture (Sampled in July-September)” (announced on October 11, 2012), “Radioactive material monitoring results of the public water in Fukushima Prefecture (Sampled in September-November)” (announced on January 10, 2013), “Radioactive material monitoring results of the public water in Fukushima Prefecture (Sampled in December-March)” (announced on March 29, 2013) (Announced by the Ministry of the Environment)

# [Reference] Impact on the Human Body (Radiation Dose)

The impact on the human body in the case of direct oral intake is considered to be quite small. The densities of cesium-137, strontium-90 and tritium are substantially lower than the annual radiation exposure due to natural radiation of approx. 2.09mSv/year (average in Japan).

\*The maximum density detected in the pump wells is used for evaluation.

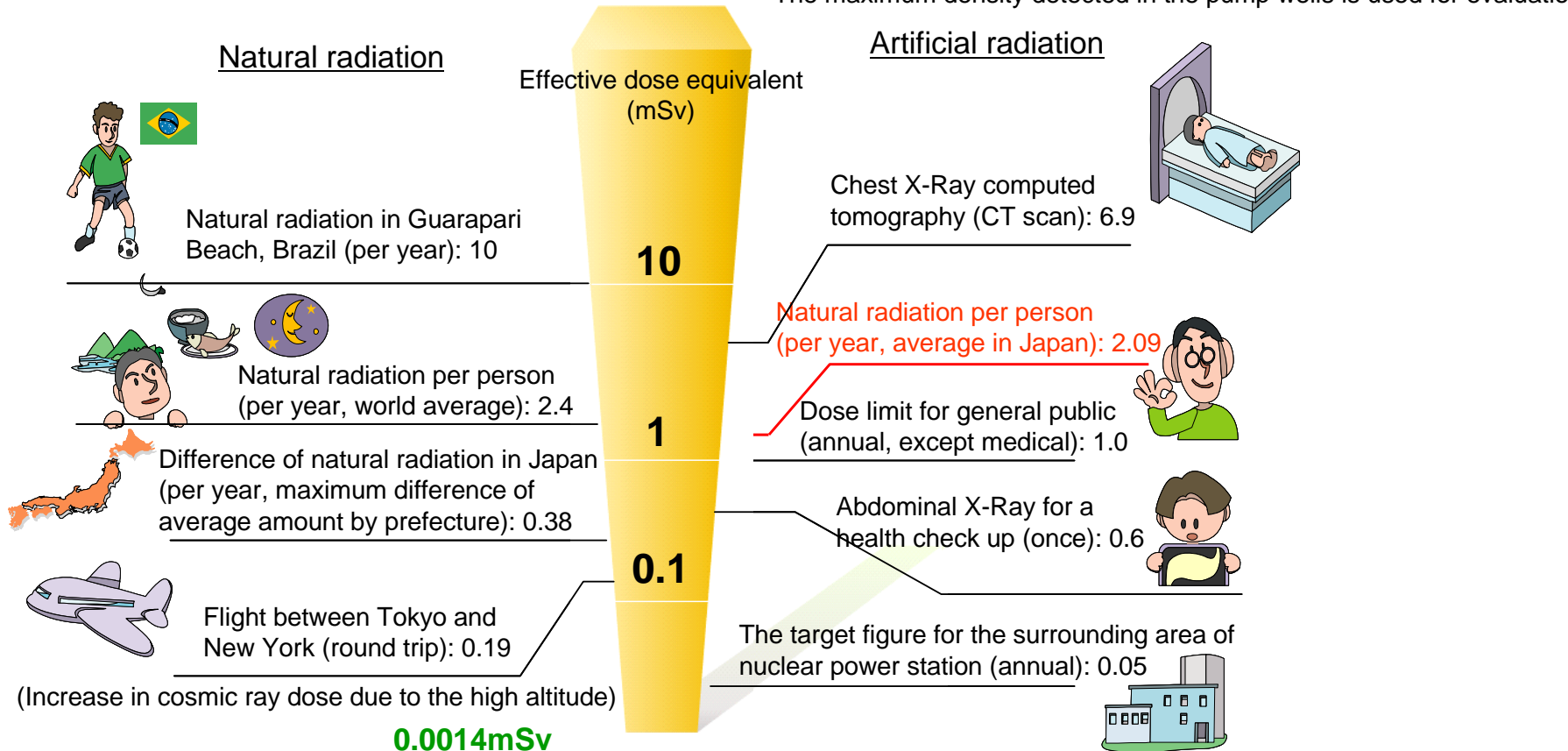

**0.0014mSv**  
(Annual radiation dose in the case of oral intake of strontium-90)

\*Radiation dose in the case of drinking 2 liters of water containing 0.068Bq/L of strontium-90 everyday. (Strontium has not been detected)

**0.0011mSv**

(Annual radiation dose in the case of oral intake of cs-137)

\*Radiation dose in the case of drinking 2 liters of water containing 0.12Bq/L of cesium-137 everyday

**0.0059mSv**  
(Annual radiation dose in the case of oral intake of tritium)

\* Radiation dose in the case of drinking 2 liters of water containing 450Bq/L of tritium everyday.

(Note) The effect of inhalation of radon is included in the natural radiation dose. (Source) UNSCEAR 2000 Report, "Sources and Effects of Ionizing Radiation" etc.

# [Reference] Gradual Reduction of Groundwater

The groundwater level will be gradually reduced with the groundwater bypass put in operation. Careful water level control will be implemented to prevent the accumulated water in the buildings from leaking to the outside while monitoring the groundwater level reduction and its water quality. The sub-drains installed around the buildings will be fully utilized for the monitoring. An observation hole will be newly installed between the Reactor Building and the pump well.

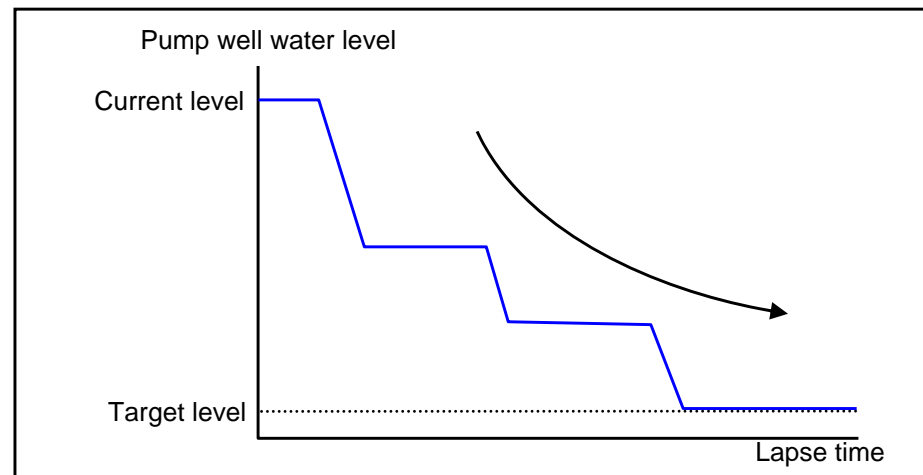
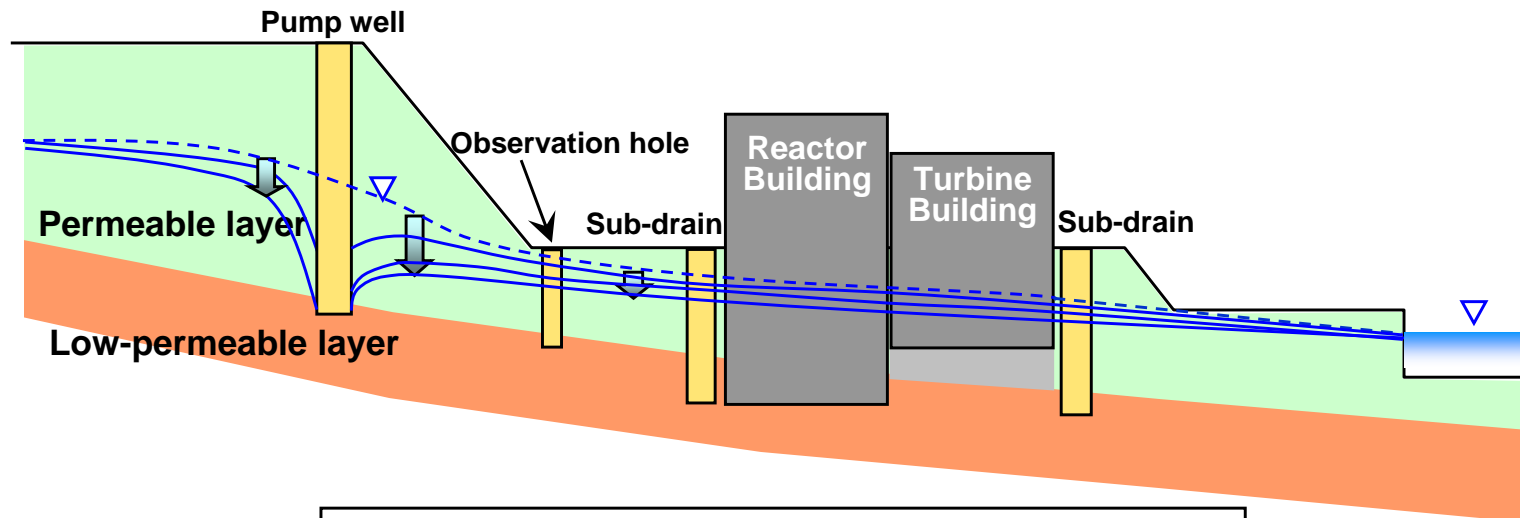

Gradual reduction of groundwater level

# [Reference] Policy of Water Level Reduction in the Early Stage

## ■ Basic policy of water level reduction in the early stage

- Water level will be reduced while carefully controlling it to prevent the accumulated water in the buildings from leaking to the outside.

[Leakage prevention]

- The accuracy of groundwater control will be improved by examining the data on water level fluctuation obtained in the early stage of pump well operation. [Accuracy improvement for the next step]

## ■ Control method

- The following will be implemented in the early stage of water level reduction in order to prevent the leakage of accumulated water.

Control item	Control method
1. Groundwater level control near the pump well by utilizing the observation hole *Confirm the effectiveness of the groundwater bypass in the early stage of its operation.	Pump well water level > Observation hole water level
2. Groundwater level control near the building by utilizing the sub-drains *Prevent the leakage of accumulated water in the buildings	Sub-drain water level > Accumulated water level in the building

\*In the case of unexpected water level reduction, measures such as suspending the pump well operation will be implemented.

### 1. Groundwater level control near the pump well by utilizing the observation hole

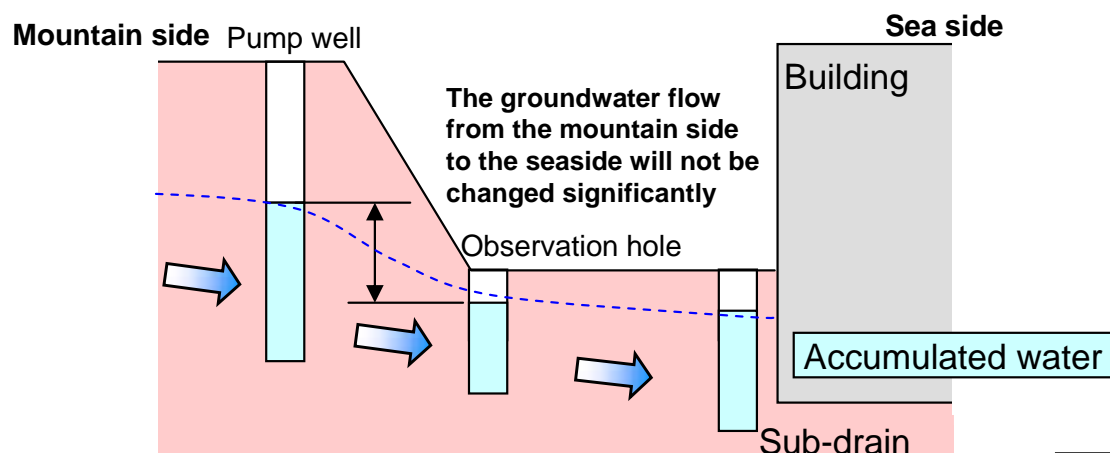

Pump well water level > Observation hole water level

### 2. Groundwater level control near the building by utilizing the sub-drains

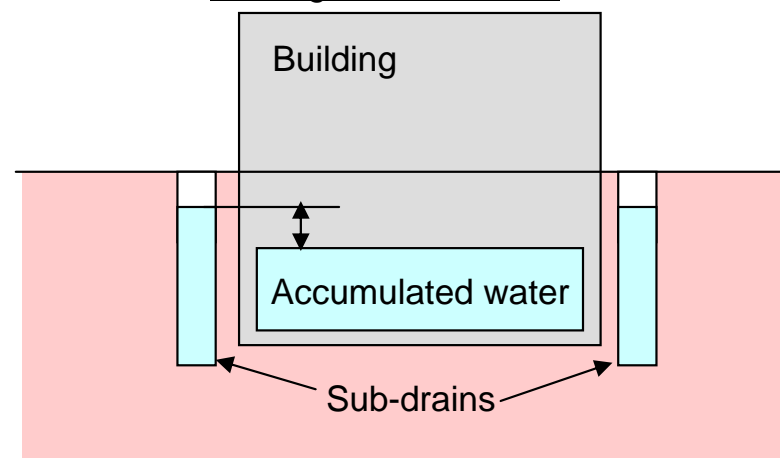

Sub-drain water level > Accumulated water level in the building

# [Reference] Monitoring Points (Groundwater Levels)

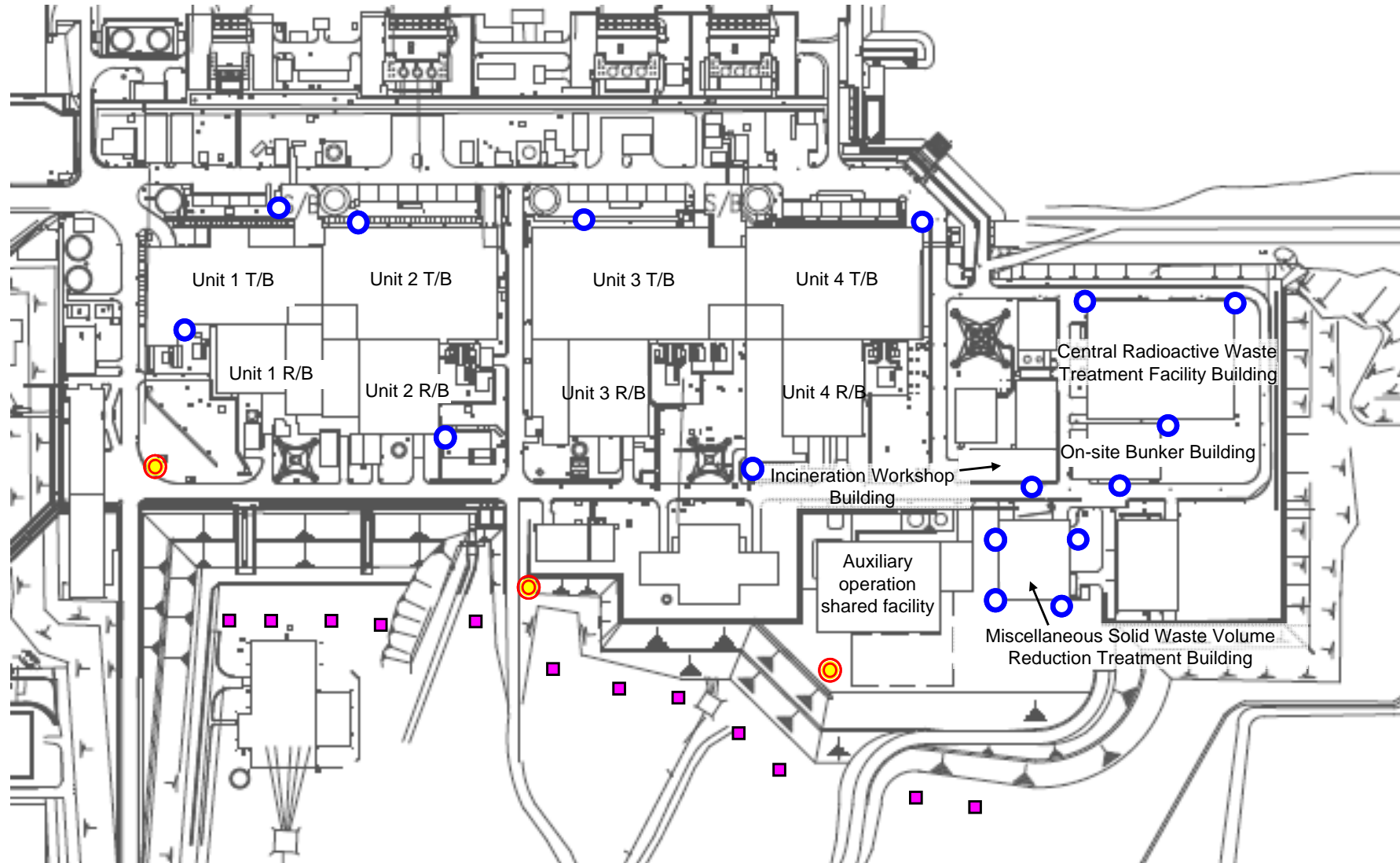

- : Observation holes for confirming the effectiveness of the groundwater bypass in the early stage of operation
- : Sub-drain pits for preventing leakage of accumulated water in buildings
- : Pump wells



# [Reference] Measures to Prevent the Radioactive Materials in the Air from Being Mixed into the Temporary Storage Tanks

In order to prevent the radioactive materials in the air from being mixed into the temporary storage tanks, the outside air supplied to the temporary storage tanks will be filtered by HEPA filter\*. The HEPA filter will be visually inspected and replaced on a regular basis.

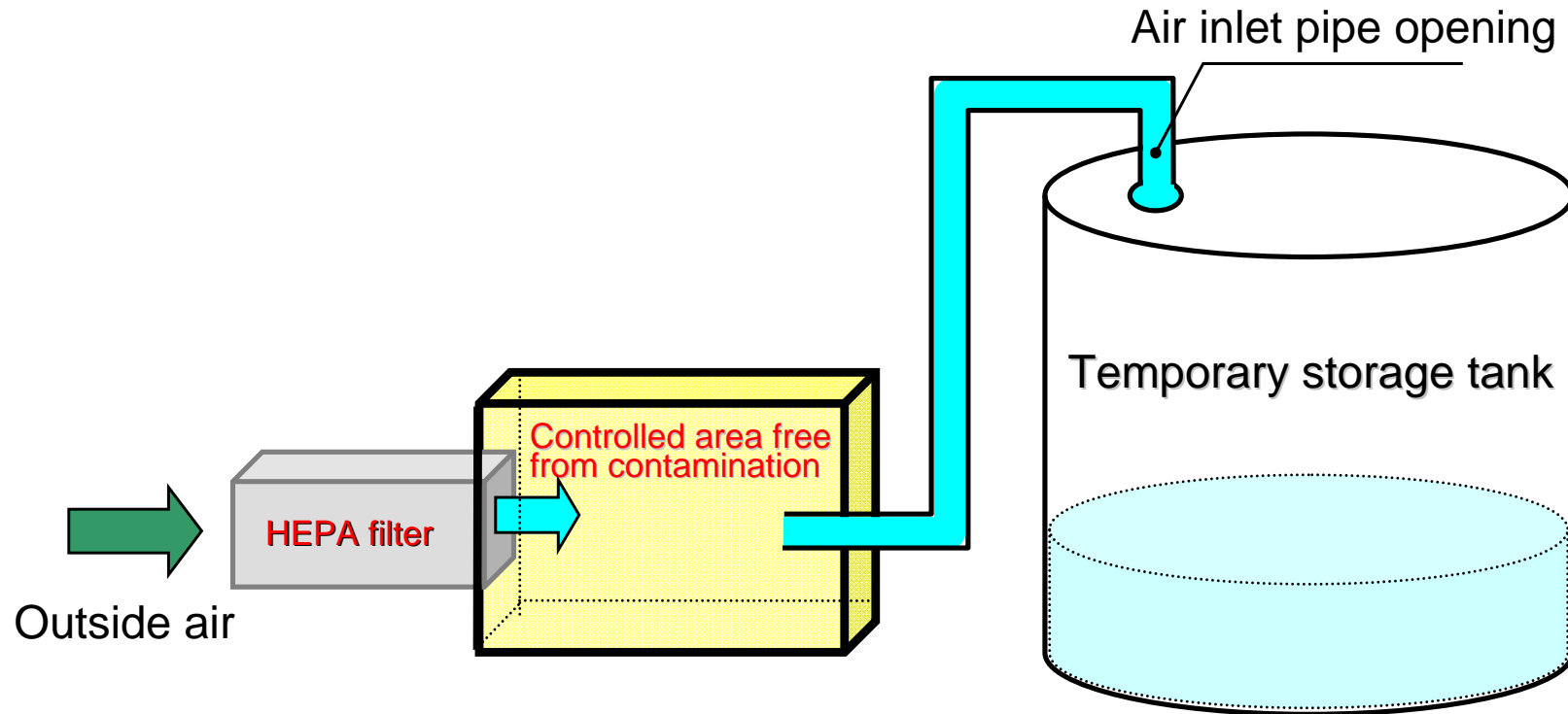

## Overview of the air inlet pipe opening of the temporary storage tank

\*HEPA filter: Filter which traps 99.97% or more of particles with a particle size of 0.3  $\mu\text{m}$ .

# [Reference] Groundwater Levels around the Buildings (Groundwater Analysis Results)



Current groundwater levels

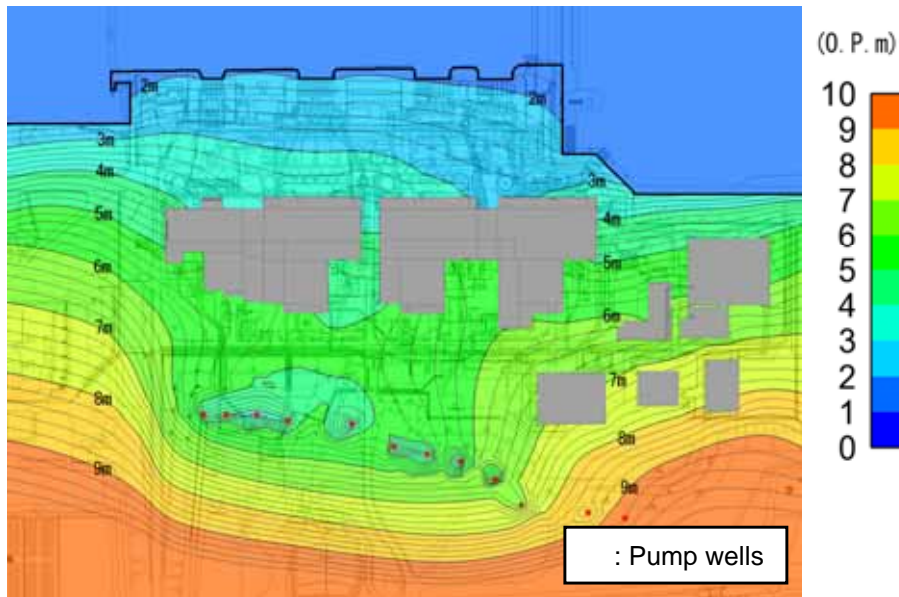

Groundwater levels after the groundwater bypass was put in operation

The analysis was performed assuming the water levels of all pump wells (12 locations) being reduced to the bottom (the maximum water level decrease).

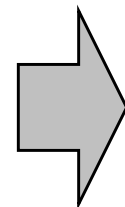

Decrease in the groundwater levels around the buildings (Comparison between before and after the operational commencement of the groundwater bypass)