

# Suspension of Unit 3 Spent Fuel Pool Circulation Cooling System at Fukushima Daiichi Nuclear Power Station: Cause Analysis and Countermeasures

< Reference >

April 15, 2013

Tokyo Electric Power Company

## 1. Overview

At 2:47 PM on April 5, 2013, in the container house where the power board for Unit 3 spent fuel pool (SFP) circulation cooling system is installed, **an alarm indicating a “power board failure” went off on the control panel** and **Unit 3 SFP circulation cooling system was suspended** during the work to cover up the opening in the lower part of the power board to prevent the entry of small animals.

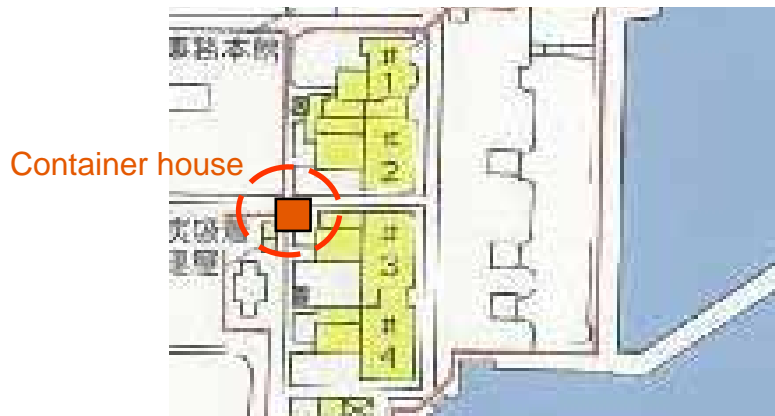

Container house

Appearance of Unit 3 container house



Container house

Inside of the container house

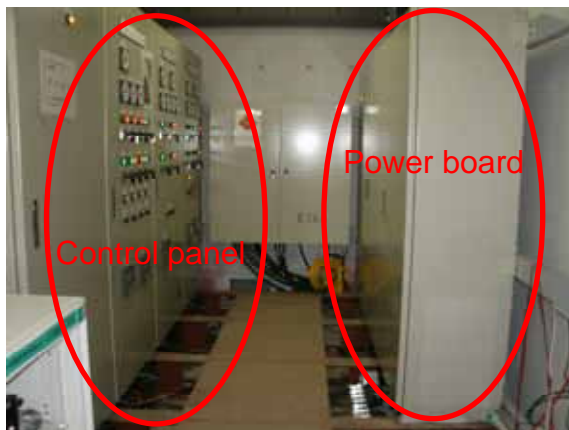

Control panel

Power board

Lower part of the power panel in the container house

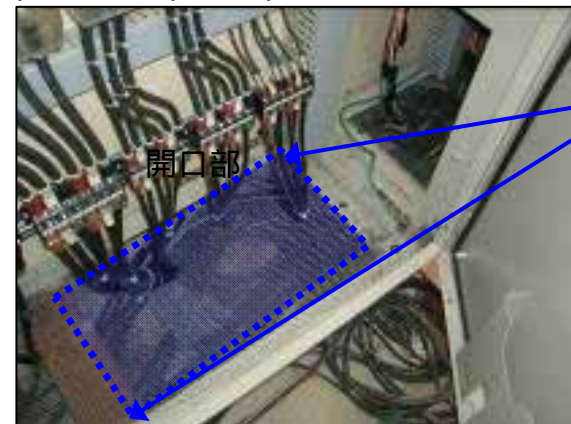

Opening

## 2. Site Investigation Results

As a result of site investigation performed after the alarm went off, **burn was found on the edge of a piece of wire and a current-carrying terminal (which were being used for the work) due to a ground fault.**

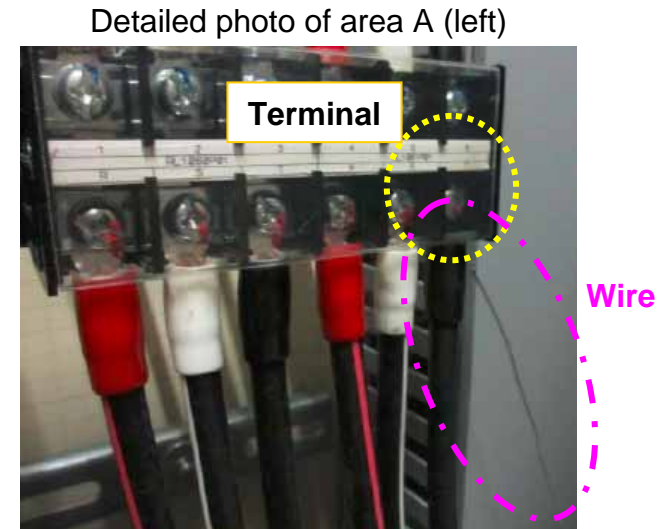
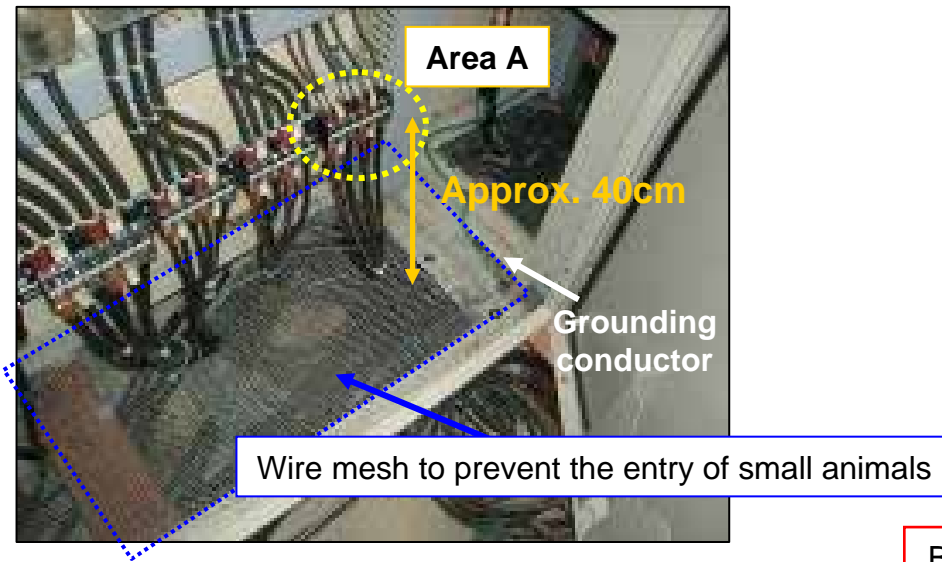

Burn found on the edge of a piece of wire and a terminal

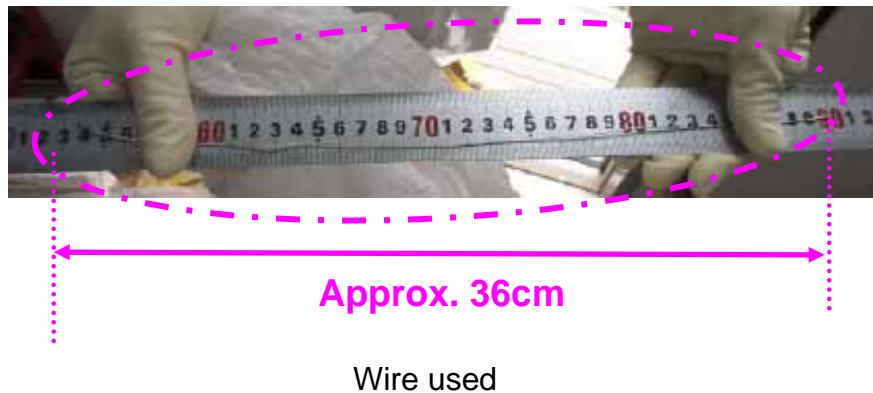

### 3. Causes of the Suspension of the SFP Circulation Cooling System

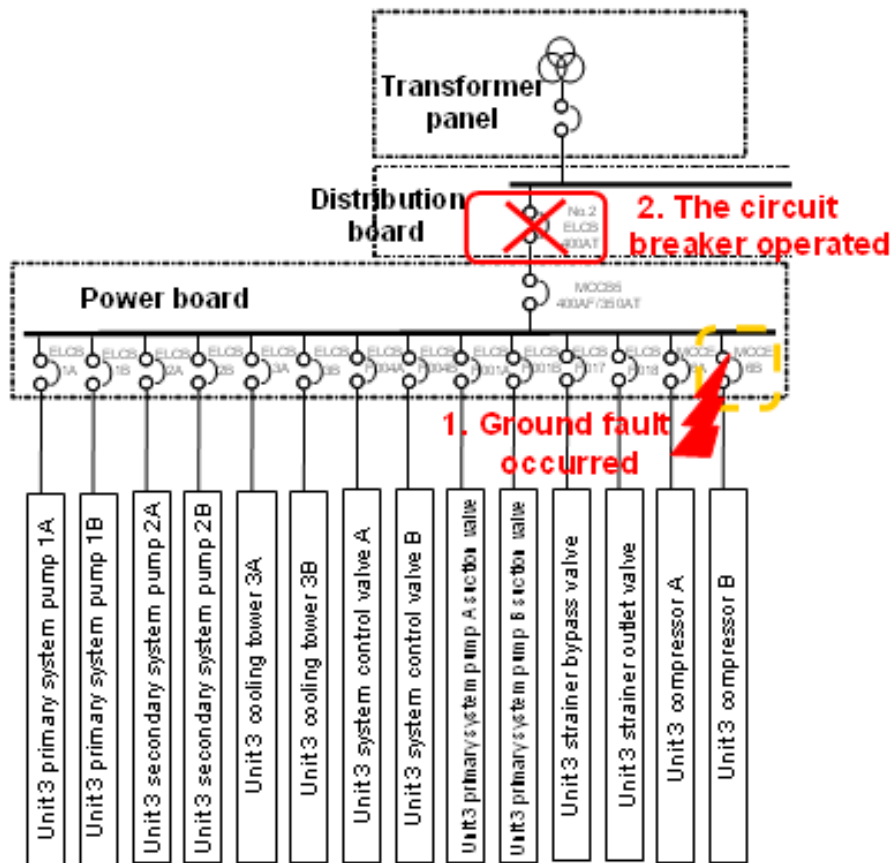

#### [Cause of suspension]

1. The wire which was being used for fixing the wire mesh touched a terminal and the terminal got connected to the grounding conductor through the wire and the wire mesh, resulting in a ground fault.
2. Due to the ground fault occurred, the circuit breaker of the distribution board in the upstream of the power board operated. As an alarm indicating a “power board failure” went off, the SFP circulation cooling system was suspended.

#### [Causes of the ground fault]

A wire mesh and wire were used for the measure to prevent the entry of small animals In order to ensure its effectiveness.

The ground fault was directly caused by not implementing any of the following measures.

- The power was not turned off during the work.
- The current-carrying area was not being protected.

In addition, as an indirect cause, the worker may have had the wire in his hand accidentally touch the terminal with his ability to concentrate lowered after long hours of work.

## 4. Factor Analysis

### ■ Management factors

- As senior personnel deemed the work to be simple and easy, they did not attend the meeting before the work implementation.
- Though the work can possibly affect power facilities, members in the mechanical field did not point out the necessity to turn off the power supply for the work.

### ■ Human factors

- After long hours of work with heavy equipment lowered the worker's ability to concentrate.
- Since it was right after the power supply failure occurred due to a small animal, the worker felt rushed to finish the work.
- The worker thought that the work would be easy and the only thing to watch for would be the risk of electric shock.

### ■ Facility factors

- Measure to prevent the entry of small animals had not yet been implemented for the facility.
- Since no earth leakage circuit breaker was installed in the power line where the ground fault occurred, the facility structure allowed for the suspension of the SFP circulation cooling system in the case of a ground fault.

# 5. Countermeasures

## ■ Countermeasures for management factors

- For the purpose of ensuring the involvement of senior personnel with simple operations, a procedure manual will be created for the work to be performed by TEPCO (all work contents except for routine work such as patrol) which will be approved by the senior personnel. The contents of safety evaluation performed beforehand will also be confirmed.
- As for the work to be performed by TEPCO (except for routine work such as patrol), a check sheet will be created to confirm the necessity of safety measure implementation (work which involves current-carrying area, heavy objects, a risk of lack of oxygen, etc. and work performed at high altitude) before work. Safety will be ensured by having the senior personnel confirm and approve the contents of the check sheet beforehand.
- The responsibility for the power facilities of the SFP circulation cooling system will be transferred to a group which specializes in electrical engineering considering the high level of expertise necessary for the work.

## ■ Countermeasures for human factors

- A work safety leader (responsible for paying close attention to work safety such as the work environment and work hours) will be clarified for each work.
- Personnel in charge of work safety will be designated for each of the related groups to review the status of safety measure implementation for the work performed by TEPCO (except for routine work such as patrol).

## ■ Countermeasure for facility factors

- Based on the review by the “Emergency Response Headquarters for Reliability Improvement at Fukushima Daiichi Nuclear Power Station” which has been newly established, additional measures will be implemented as necessary.