TEPCO's Safety Assurance Philosophy on Nuclear Power Generation Plants

January 25, 2013

Tokyo Electric Power Company, Inc.

This English translation has been prepared with the intention of creating an accurate and complete reflection of the original Japanese version for the convenience of our English-speaking audience. However, if there are any discrepancies between the translation and the original, the latter shall prevail.

This document summarizes our basic safety assurance philosophy on nuclear power generation plants based on the lessons learned from the accident at Fukushima Daiichi Nuclear Power Station. The contents will be reviewed from the viewpoint of continuous improvement.

Insufficient defense-in-depth against external events

[Facts]

- Design basis tsunami height was too low (measures against first level of protection was not sufficient).
- Latter-stage systems (i.e., third and fourth levels of protection) lost their functions simultaneously in wide range.
- We were forced to think out and take actions simultaneously immediately after the occurrence of accident, making it difficult to provide effective actions and time margin.

[Lessons learned]

- It is important to improve individual levels of protection of defense-in-depth against external events so that the events will not easily affect the latter stage even when they exceed the postulated design basis.

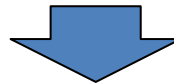

[Basic action policy]

- Under the assumption that external events would occur, the following arrangements must be provided for major functions of individual levels of protection (i.e., “prevention of abnormal event”, “stoppage”, “cooling”, and “containment”):

Establishing new design basis where additional requirements are arranged in a part of design basis.

Establishing the design category, DEC (Design Extension Condition), that exceeds the design basis to increase the magnitude of the action in a level of protection.

Designing those facilities that can accept the DEC.

Lessons learned from Fukushima (2/3)

Improvement of high pressure core injection and depressurization functions based on station black out

[Facts]

- In Unit 1, the emergency condenser hardly worked and the high pressure core injection system lost its functions.
- Units 2 and 3 respectively relied on the sole high pressure core injection system for a long period, making it difficult to depressurize the reactors.

[Lessons learned]

- It is necessary to improve the high pressure core injection capability, which will be required immediately after occurrence of accident, based on the SBO (Station Black Out).
- Prolonged maintenance of main steam relief safety valve functions is not sufficiently considered for the conventional LOCA-based design basis events. Therefore, it is necessary to extend the working period of this valve.



[Basic action policy]

- In addition to preventive measures against occurrence of SBO, it is necessary to assume occurrence of SBO in both design base and DEC in order to improve the high pressure core injection and depressurization capabilities.

Lessons learned from Fukushima (3/3)

Clarification of design requirements for containment vessels as fourth protection-level facility

[Facts]

- The containment vessel was damaged due to excessive temperature elevation to release radioactive materials into the external environment.
- There is no concrete design requirement for the post core damage accident containment capability.
 - The containment has been designed based on the requirements from LOCA.
 - Past arrangements targeted for the accident management have been served for effective utilization of current nuclear power plant facilities and, therefore, the fourth protection-level system has not been improved.

[Lessons learned]

- It is necessary to improve facilities, in addition to management methods, to mitigate the impacts and control the release of radioactive materials after the core damage accident.

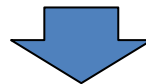

[Basic action policy]

- For containment vessels and containment vessel protection facilities, design requirements must be clarified as fourth protection-level systems and the containment capability must be improved.

External events equally affect the facilities belonging to individual levels of protection of defense-in-depth.

- In the accident at Fukushima, the tsunami whose magnitude exceeded the design basis disabled the functions of latter-stage levels of protection (except for the function of “stoppage”).
- It is, therefore, necessary to take measures against all levels of protection of the defense-in-depth.

To improve the defense-in-depth, DEC will be added to the design process in addition to the sophistication of design basis of each level of protection.

Design requirements for the facilities into which DEC will be arranged

- The objective is to maintain the key functions of each level of protection at a given degree even when a multiple failure accident that exceeds the design basis would occur.
- It is necessary to enhance the diversity that allow response to the complicated situation after the occurrence of multiple failure accident and consequently get various action options.

SBO that should be essentially handled as DEC is defined as a design base from the viewpoint of improvement of high pressure core injection and depressurization capabilities.

- Single failure of active component -> Backup by RCIC is needed.
- Length of operating time -> SRV must keep its function without pause for the required period.

Design requirements for each level of protection of defense-in-depth mainly based on external events

Improvement of defense-in-depth

Improvement of functions of each level of protection (improvement of each level of protection of defense-in-depth)

Level of protection	Objective (key function)	Requirement as design base	Requirement as DEC (permanent facilities and transportable equipment are used based on the phased approach discussed later)
1st level	Prevention of occurrence of abnormal event (Prevention of abnormal event)	In case of tsunami: To prevent SBO caused by design basis tsunami and resultant loss of safety functions assigned to each level of protection in the latter stage.	In case of tsunami: Taking into consideration the malfunction of anti-tsunami system, the facilities must maintain their functions even when the building is flooded to some extent. It must be possible to drain the water from vital zones.
2nd level	Prevention of expansion of accident (stoppage)	No change from current strategy (Even when one control rod having maximum reactivity value cannot be inserted, protection systems must be able to put the reactor into subcritical state. The nonessential system must be able to cool the reactor.)	No change from current strategy (Any other equipment than control rods must be able to put the reactor into subcritical state. The reliability of control rods must be increased.)
3rd level	Prevention of core damage (cooling)	Cooling: The water injection must be able to cool the reactor to prevent occurrence of SBO even when a single failure of active component is assumed.	Cooling: It must be possible to cool the reactor by means of water injection or heat sink provided by diversified or multiple facilities even when SBO lasts long.
		Depressurization: The reactor must be depressurized to prevent occurrence of SBO even when a single failure of active component is assumed	Depressurization: It must be possible to depressurize the reactor by using diversified or multiple facilities even when SBO lasts long.
4th level	Effect mitigation and release control after core damage (containment)	The containment vessel and containment protection facilities must prevent prolonged contamination of soil and uncontrolled release of radioactive materials.	

The system design is discussed here and therefore, the fifth level of protection that handles the disaster prevention is omitted.

Items added as new DEC categories

Item already defined as traditional DEC category in Europe

Major actions taken for each level of protection of defense-in-depth

Improvement of defense-in-depth

	Objective	Design base	DEC
1st level	Prevention of occurrence of abnormal event	In case of tsunami: Tide wall, sea wall, sea plate, and waterproofing of building penetration	In case of tsunami: Installation of flood prevention facilities in vital zones and drain system for vital zones
2nd level	Prevention of expansion of accident	No change from current strategy, except for improvement of switchyard	No change from current strategy
3rd level	Prevention of core damage	Cooling: Diversified high pressure core injection methods are added in addition to conventional ECCS and RCIC.	Cooling: Improvement of RCIC DC, CUW and power supply vehicle, NUWC and power supply vehicle, fire engine, diesel pump, vehicle-mounted alternative seawater heat exchanger, W/W vent, filter vent (before core damage)
		Depressurization: For the SRV, special DC and nitrogen cylinders are improved and the nitrogen supply pressure is increased.	Depressurization: Improvement of special DC and nitrogen cylinders, increase of nitrogen supply pressure, compressor for SRV operation, and diversification of depressurization measures (under study)
4th level	Effect mitigation and release control after core damage	Alternative spray, water injection to pedestal, CV flange watering, filter vent (after core damage; via W/W and D/W), and catalytic hydrogen recombiner	

The system design is discussed here and therefore, the fifth level of protection that handles the disaster prevention is omitted.

Items added as new DEC categories

Item already defined as traditional DEC category in Europe

Phased approach concept

Unless measures are selected properly based on the time margin, they fail to work effectively to ensure the safety.

It is necessary to properly define design requirements for the measures from the viewpoints of time margin and substitutability.

- Initial stage of accident: It is likely that the human resources are limited and access to the site is difficult. -> It is appropriate to design permanent facilities so that initial action can be taken at least for them.
- Latter stage of accident: Complicated situation is generated and thus it is likely that the accident cannot be handled only by the permanent facilities. -> It is important to add transportable equipment as options and increase the diversity and substitutability of action.

Measures are determined on a stage-by-stage basis according to the time margin. (Phase approach)
 -> The phased approach is applied as a strategy for enhancement of defense-in-depth based measures.

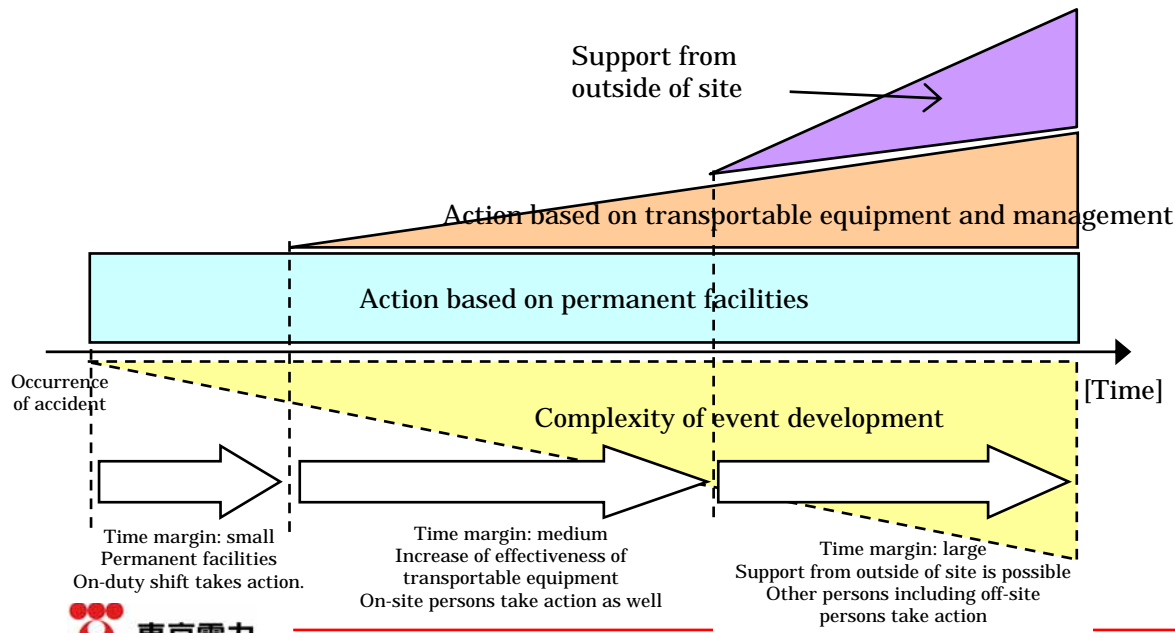

Philosophy on selection of action
 Removing common cause failures is important specifically for external events.
 -> Great importance is attached to the diversity (driving system, cooling method of power supply systems, etc.) and spatial dispersion instead of multiplicity.

Reference: Solution by design base using phased approach

- Settling conditions: Cold shutdown by seawater system must be established without damage to fuels.
- Completion time: Taking into consideration the troubles in Fukushima Daini NPS, the safety system must be designed in such the manner that the accident can be settled with 72 hours.
- Phase: The following three phases are defined from the viewpoints of time margin and substitutability of action. The off-site support is not expected.

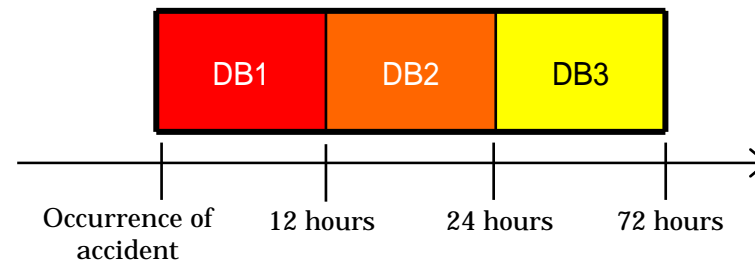

* The concept of the phased approach is schematized as shown left. Currently, DB1 is the only design base under study.

Phase 1 (DB1): Time range having small margin of action (up to 12 hours)

- Active components that are required for the action based on permanent facilities or the initial stage of event are automatically started. (However, if the automatic start impairs the safety and these components can be started in the manual mode through, for example, training, this automatic start sequence is not needed.)

Phase 2 (DB2): Time range having increased margin of action (up to 24 hours)

- For Phases 2 and 3, the action with transportable equipment is also expected.

Phase 3 (DB3): Same as phase 2 (up to 72 hours (= completion time))

- Flexible action with transportable equipment is very important.
- Taking into consideration that the operating time will be prolonged, the diversity or multiplicity must be ensured depending on various factors including reliability of each component.

Reference: Solution by DEC based on phase approach

Phased approach

- Settling conditions: Effects brought from the core damage is controlled and stable cool down at or below 100°C under atmospheric pressure.
- Completion time: The safety system must be designed in such the manner that the accident can be settled within 7 days.
- Phase: The following three phases are defined from the viewpoints of time margin and substitutability of action.

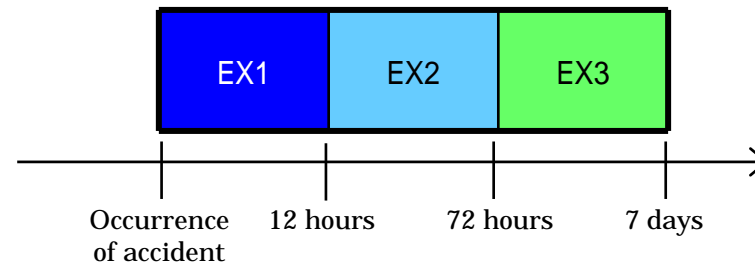

Phase 1 (EX1): Time range having small margin of action (up to 12 hours)

- DEC components that are needed for the action with permanent facilities having DEC strategy or the initial stage of event must be started automatically.
- The diversity or multiplicity must be ensured from the viewpoint of entire functional reliability of facilities including those having DEC strategy.

Phase 2 (EX2): Time range having increased margin of action (up to 24 hours)

- Flexible action with transportable equipment is very important.
- Taking into consideration that the operating time will be prolonged, the diversity or multiplicity must be ensured depending on various factors including reliability of each component.

Phase 3 (EX3): The off-site support is also expected. (Up to 7 days = completion time)

For existing reactors, different from the reactors that will be newly installed, nuclear fuels have been already loaded and, therefore, effective safety improvement measures should be provided promptly. In some cases, approaches different from those applied to the reactors that will be newly installed may be used.

Safety improvement options for existing reactors

- Addition of new permanent facilities
- Combination of existing permanent facilities and those facilities allowing diversity or spatial dispersion against external events
- Combination of nonessential system, transportable equipment, and management (documented procedures, training, and organization)
- Improvement of management method

Measures must be selected taking into consideration the connection with existing facilities (specifically important for external events), site-specific conditions, reality of action against accident (phased approach), and other factors.

In handling of external events, diversified actions must be taken speedily to effectively increase the safety under the recognition that measures with different quality (i.e., diversified measures) are important instead of complete conformity to various standards.

Measures though out must be continuously improved to increase the safety without maintaining them at a given level.

Safety improvement approach for increased safety (example)

We judge improving the high pressure core injection system is important based on the lessons learned from the accident at Fukushima.

- Such the design must be provided that the reactor can be cooled through the water injection even when a single failure of active component is assumed during SBO.

Safety improvement options for above judgment

- Addition of new permanent facility: Alternative high pressure core injection system (HPAC) is installed.
- Combination of existing facilities and facilities with diversity: The reactor is depressurized while the high pressure core injection system driven by the gas turbine generator is being operated for a short time.
- Improvement of management method: The on-site RCIC startup procedures are established. Then, operators are trained to master such startup procedures.

The following measures are provided to promptly and effectively improve the safety.

- The on-site RCIC startup procedures are established. Then, operators are trained to master such startup procedures.
- In addition, a new arrangement is introduced that allows short-time operation of existing high pressure core injection system. (Concretely, the gas turbine generator is connected to the emergency power unit installed on a hill and is put into standby state.)

The phased approach is introduced to study the action with permanent facilities from the viewpoint of time margin. It is necessary to commence installation of HPAC as a part of continuous improvement program.

Reference: Concrete improvement program for alternative high pressure core injection system (1/2)

Safety improvement of existing reactors

Alternative high pressure core injection system (HPAC)

If the RCIC fails in startup or continuous operation, the alternative high pressure core injection system that can be started earlier is used to maintain the reactor water level and thus prevent the core damage.

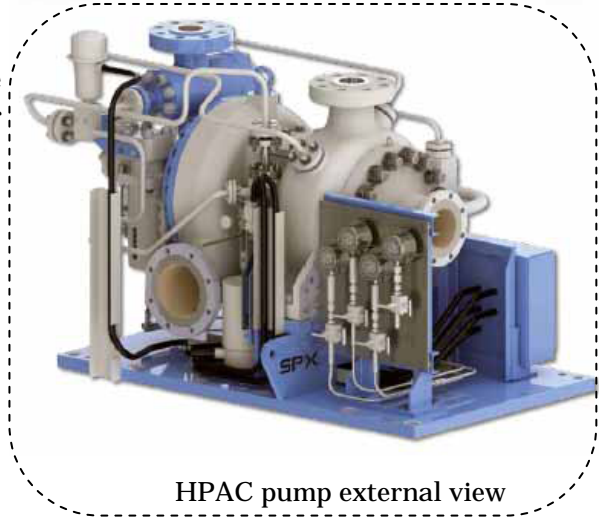
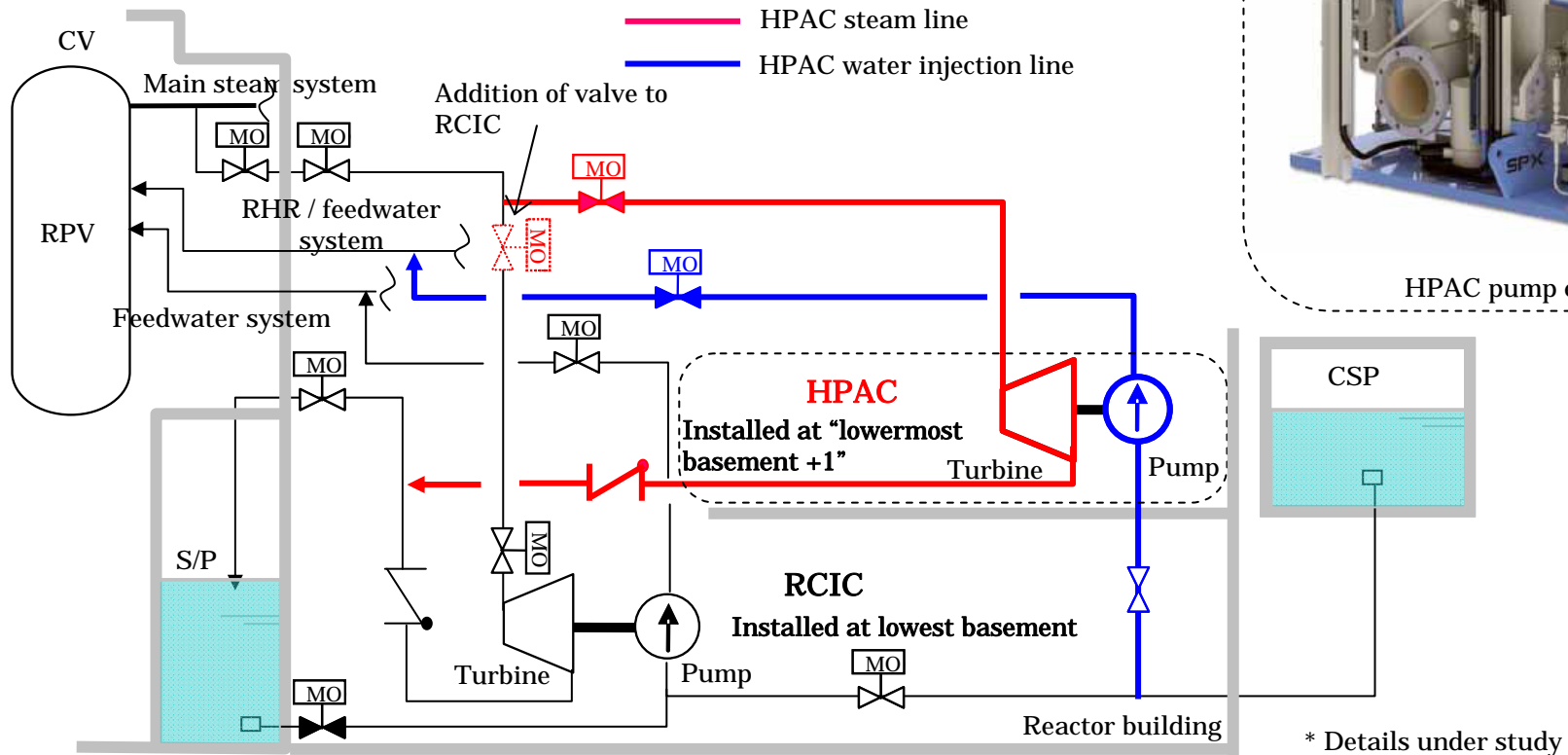

Design conditions:

- Using the pump (steam driven pump) that does not consume the electric power increases the plant survivability in case of SBO.
- Installing the HPAC on the story above the RCIC allows spatial dispersion.

Reference: Concrete improvement program for alternative high pressure core injection system (2/2)

Safety improvement of existing reactors

Short-time operation sequence used by the high pressure core injection system (HPCF) under SBO condition

System outline

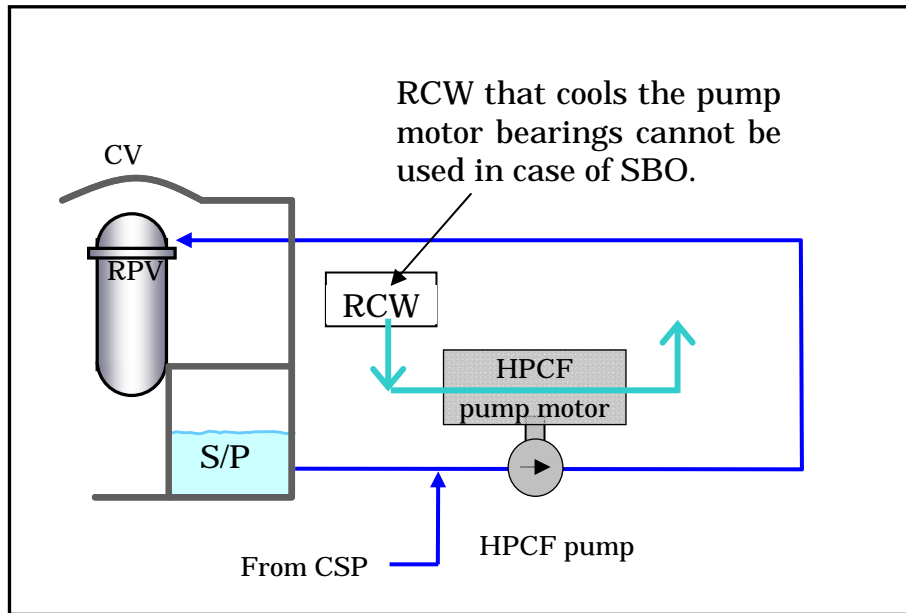

Time series events at accident (example)

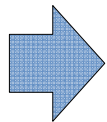
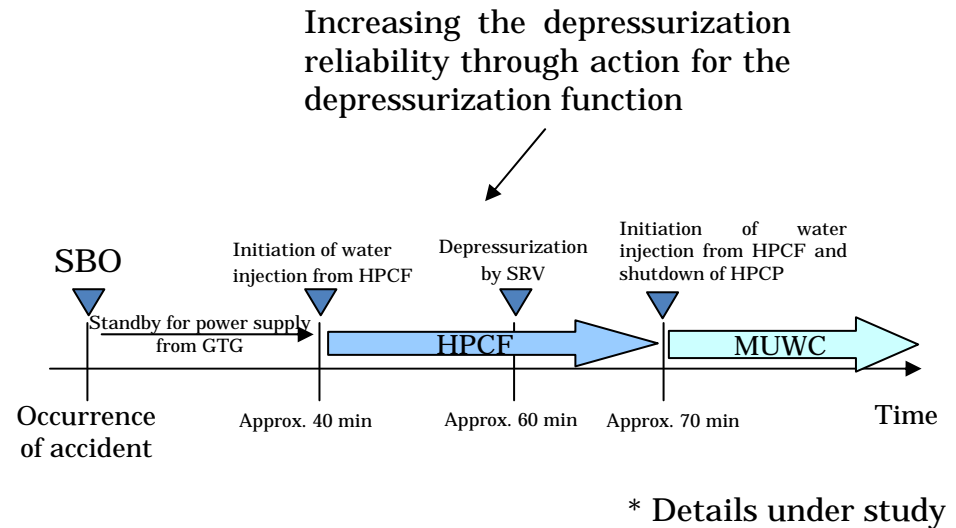

- The HPCF can be operated for about 30 minutes with cooling of motor bearings.
- Analysis has proved that the core is not damaged when the reactor is depressurized 20 minutes after the start of water injection from the HPCF and the water is injected from the MUWC further 10 minutes after the depressurization.

* For BWR-5 plants, the core is protected from the damage by the combination of rapid depressurization and low pressure core spray system (LPCS).

Design requirements for the containment vessel as forth protection-level facility

Containment
vessel

The design requirements must be met by using the entire containment system contributing to effect mitigation and release control after core damage instead of single containment vessel.

- Containment vessel, alternative spray, water injection to pedestal, W/W vent, filter vent (after core damage), etc.

Standard

- To prevent the containment vessel from damage by cooling the molten core, cooling the containment vessel (through spraying, S/P cooling, and venting), and treating incompressible gases (venting).
- To ensure a given level of heat removing efficiency through spraying, scrubbing in W/W, and filter vent.

Performance target of entire plant (evaluation base)

- Designing the facility that mitigates the effects before the core damage and meets the above standards reduces the amount of released radioactive materials (evaluated released amount) to not more than 1/X of that observed at Fukushima to prevent prolonged contamination of soil.

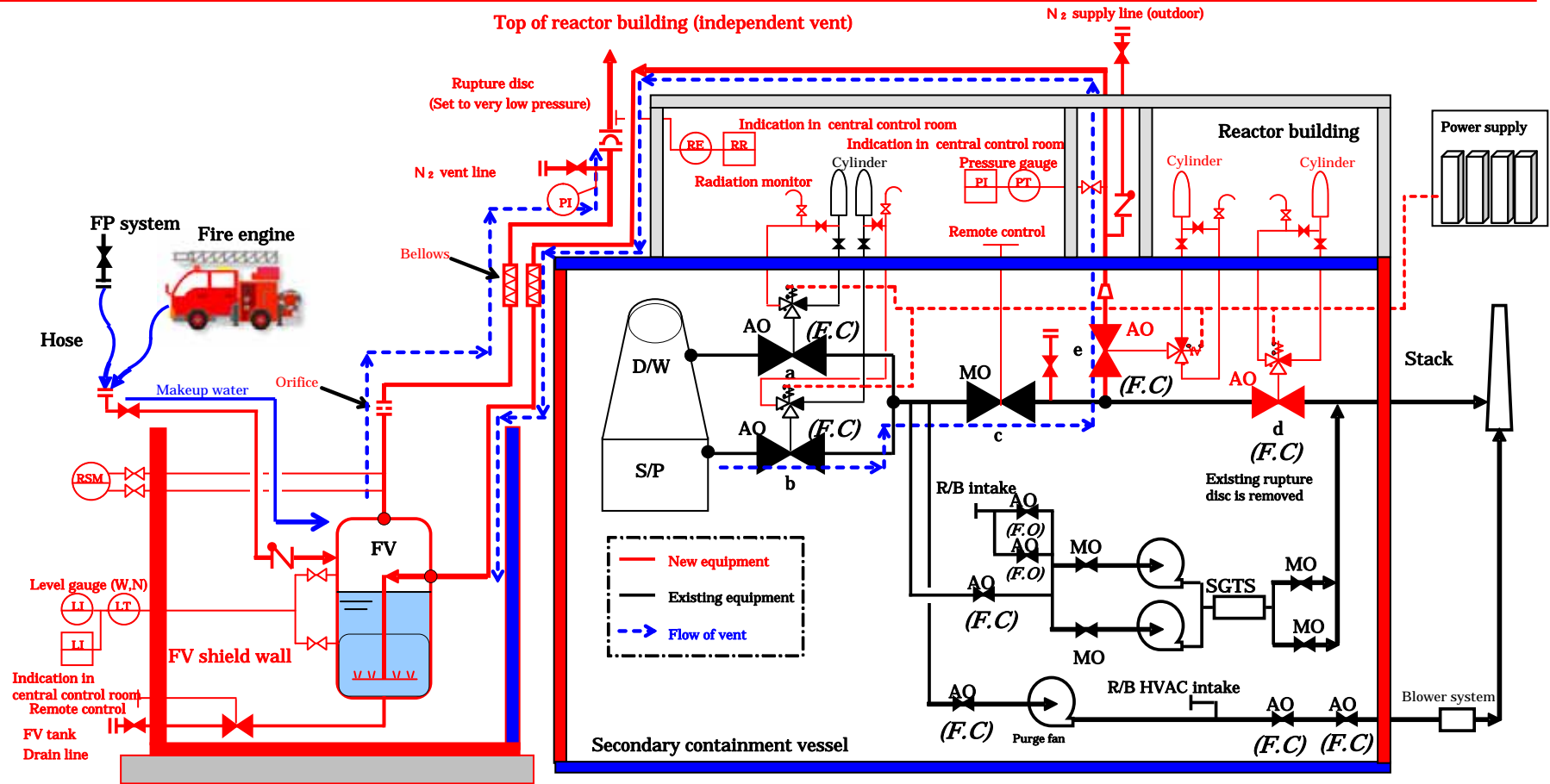

Design conditions

- The PCV vent valve must be operated even during SBO. (Operation with battery and air cylinder, and manual remote control)
- The PCV vent valve must be operated from the outside of the secondary containment vessel. (Radiation protection)
- The vent gas must not enter into other systems. (Isolation with valves and establishment of independent exhaust line)

Reference: Filter vent facility 2/2

Containment vessel

Installation of filter vent facility was started in Kashiwazaki Kariwa Nuclear Power Station Unit 7 on January 15, 2013.

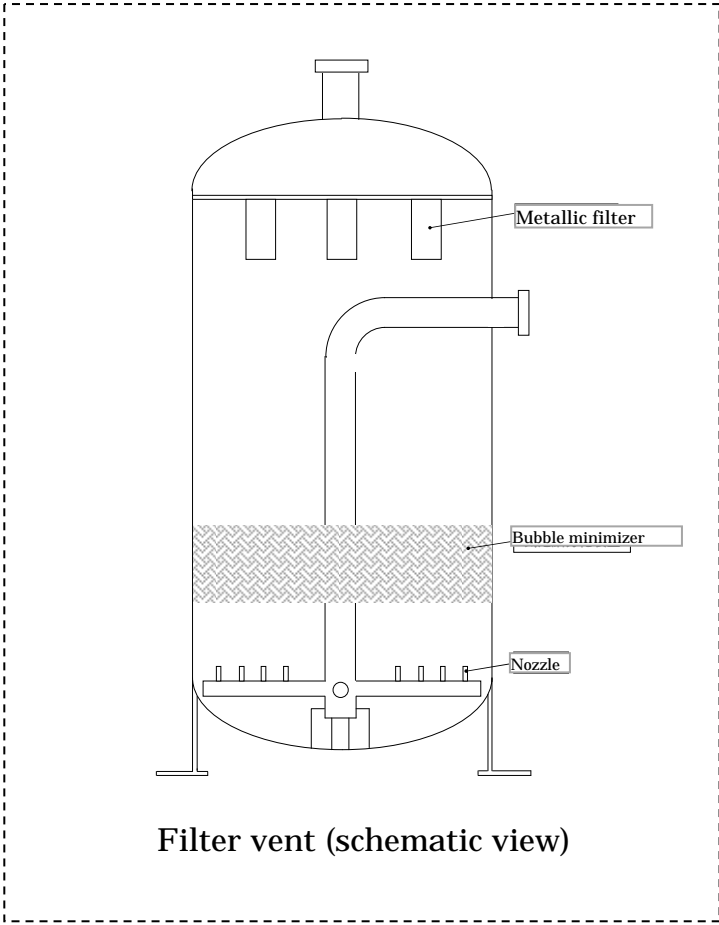
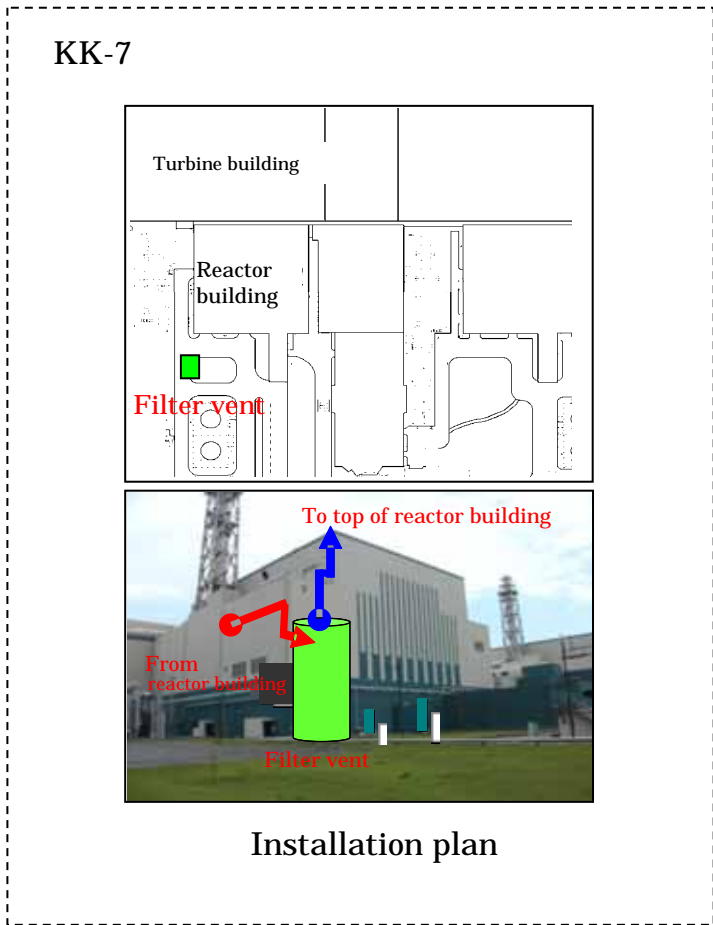

Modification of facilities in Kashiwazaki Kariwa Nuclear Power Station Unit 7 based on safety assurance

Transportable equipment
 Permanent facility spatially dispersed against existing facilities
 Permanent facility
 Items identified by red frame
 Action based on documented procedures and the like
 Facilities installed or those whose installation are under study after the accident at Fukushima

First level of protection: Prevention of occurrence of abnormal event (in case of tsunami)

- Measures will be taken to protect the building from flooding even when the tsunami that exceeds the design basis would occur.
- Anti-flooding and drain systems will be designed for rooms where vital components are installed when the reactor building is flooded.
- Basically, permanent facilities will be installed taking into consideration various factors: action is needed at the initial stage of accident; and occurrence of abnormal event must be avoided.

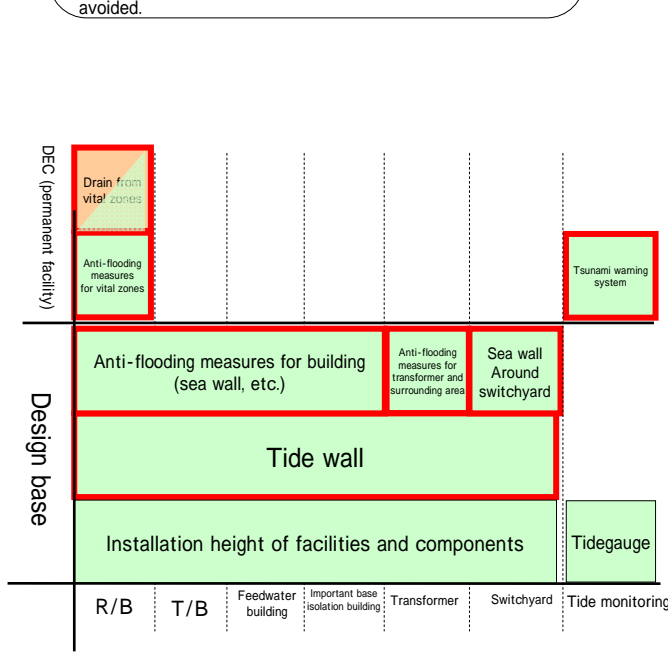

Third level of protection: Prevention of core damage (water injection, depressurization, circulating cooling)

- High pressure core injection function will be improved at both design base and DEC by defining SBO as design base.
- Improvement of depressurization function is under study.
- For further action after low pressure core injection, diversified measures, including introduction of transportable equipment, will be taken.

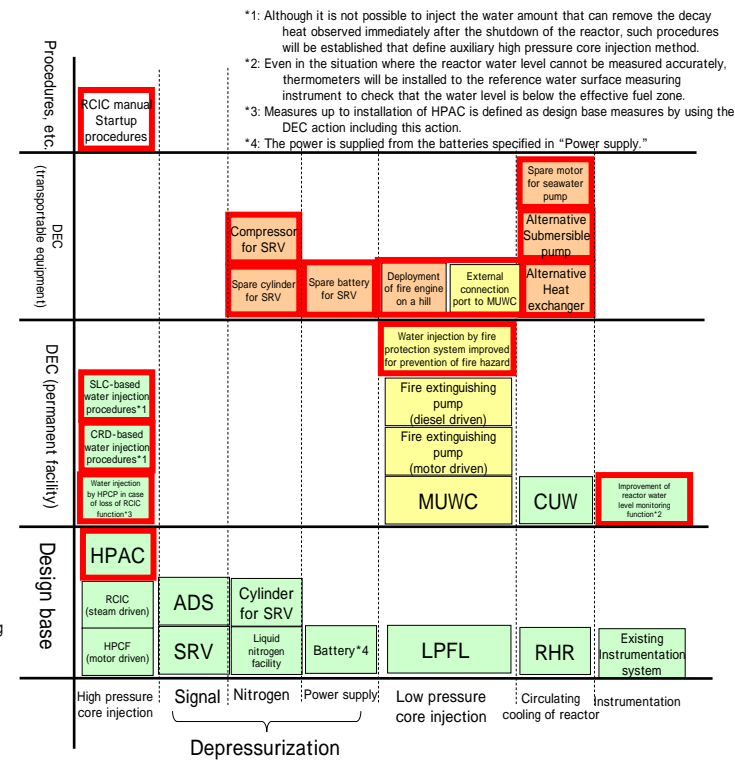

Fourth level of protection: Effect mitigation and release control after core damage

- Measures where installation of permanent facilities is a key player will be taken as DEC.

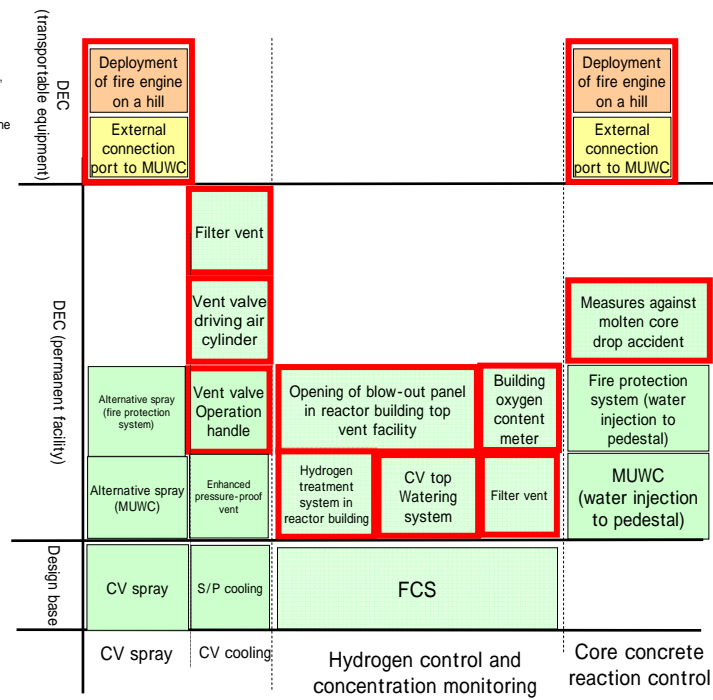

Common to all levels of protection: Prevention of core damage or effect mitigation after core damage (power supply)

- The power supply is the facility that supports the functions of each level of protection and needs the highest reliability. Therefore, measures where installation of permanent facilities spatially distributed is a key player will be taken as DEC.

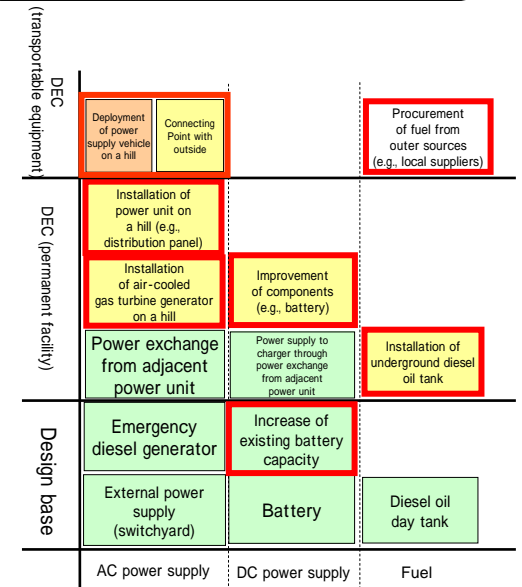

Common to all levels of protection: Prevention of core damage or effect mitigation after core damage (water source)

- The water source is the support element common to all levels of protection. Therefore, measures where installation of permanent facilities spatially distributed is a key player will be taken as DEC.

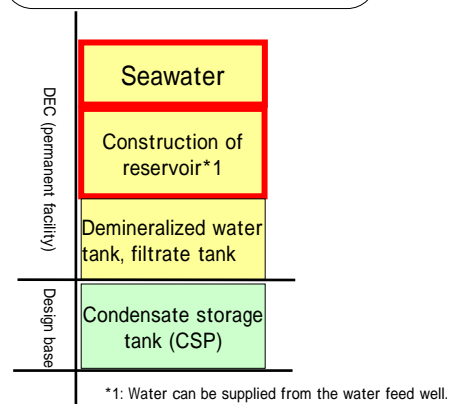

*1: Water can be supplied from the water feed well.

Others: Cooling of fuel pool

- Since the time margin is large, measures based on transportable equipment will be taken.

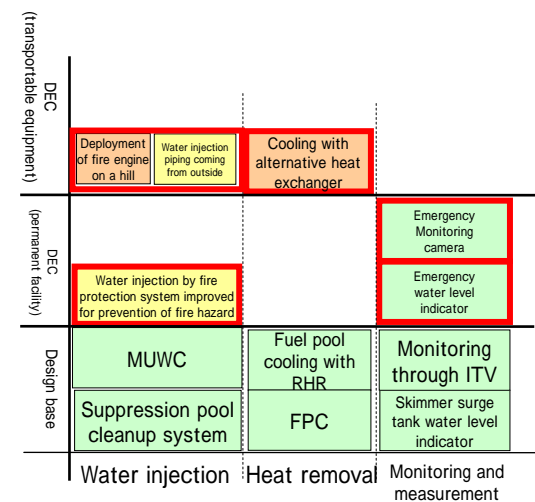

Others: Maintenance of aseismicity of nonessential systems

- From the viewpoint of effective utilization of nonessential systems in the emergency situation, additional aseismic design will be provided.

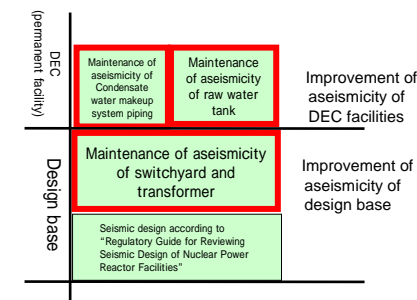

Others: Safety measures based on other viewpoints

- Measures against those functions that are important to accident handling will be taken.

