

March 31, 2016
Tokyo Electric Power Company

Air Dose Rates inside the Buildings

Sampling Period

Unit 6: from January 1, 2016 to January 31, 2016

Fukushima Daiichi NPS

Unit 6 Reactor Building 2nd Basement Floor

[mSv/h]

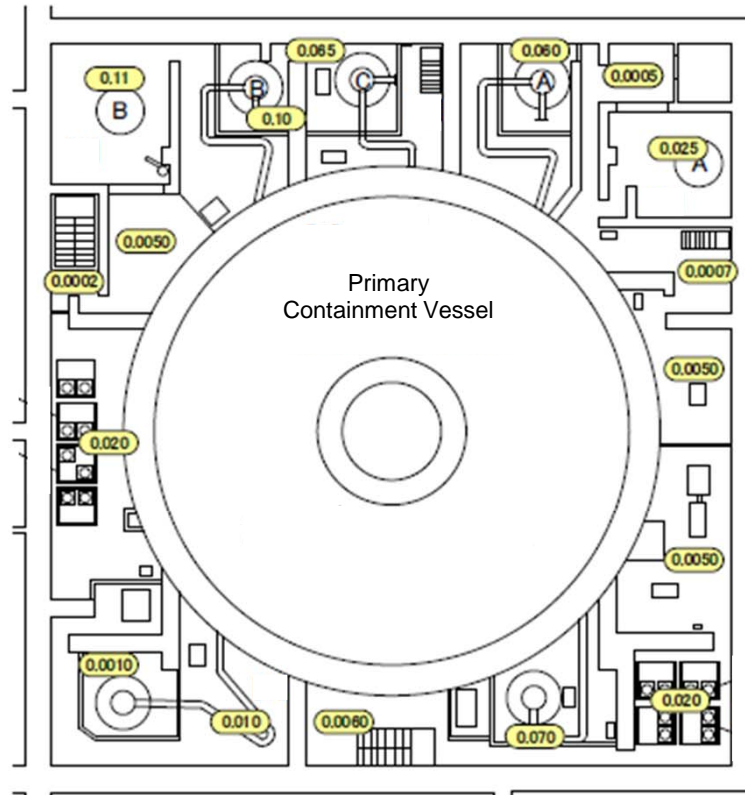
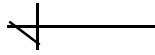

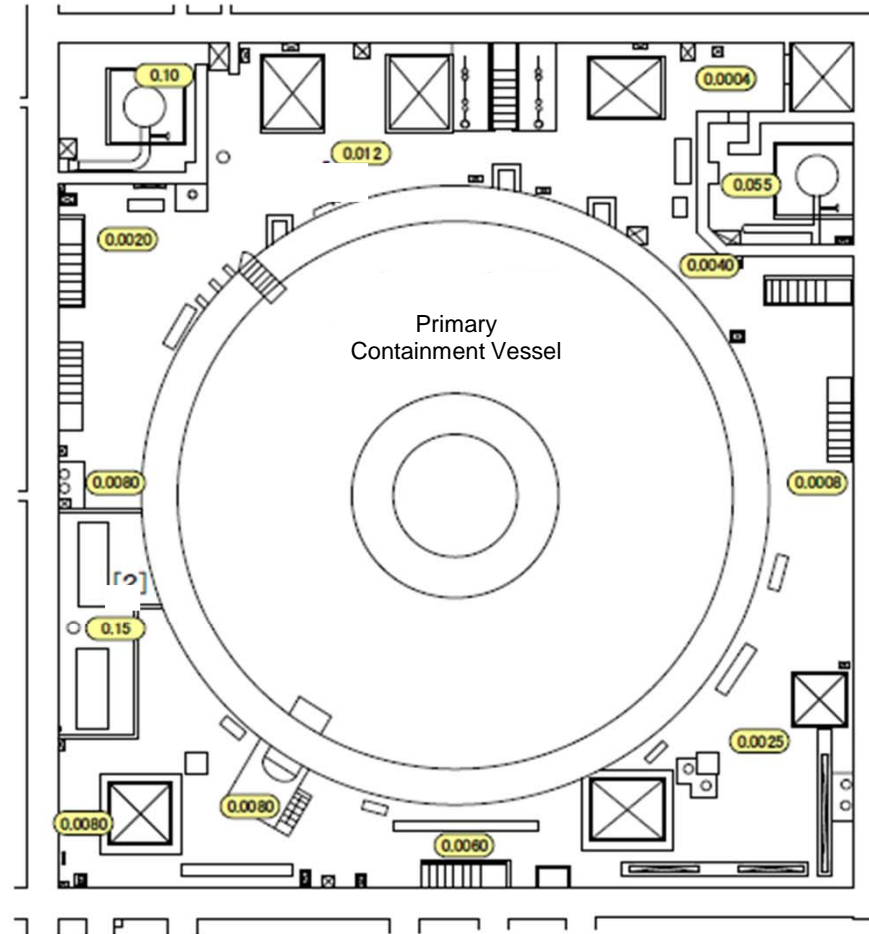
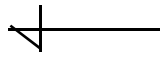

Fukushima Daiichi NPS	Unit 6 Reactor Building 1st Floor	[mSv/h]
-----------------------	-----------------------------------	---------

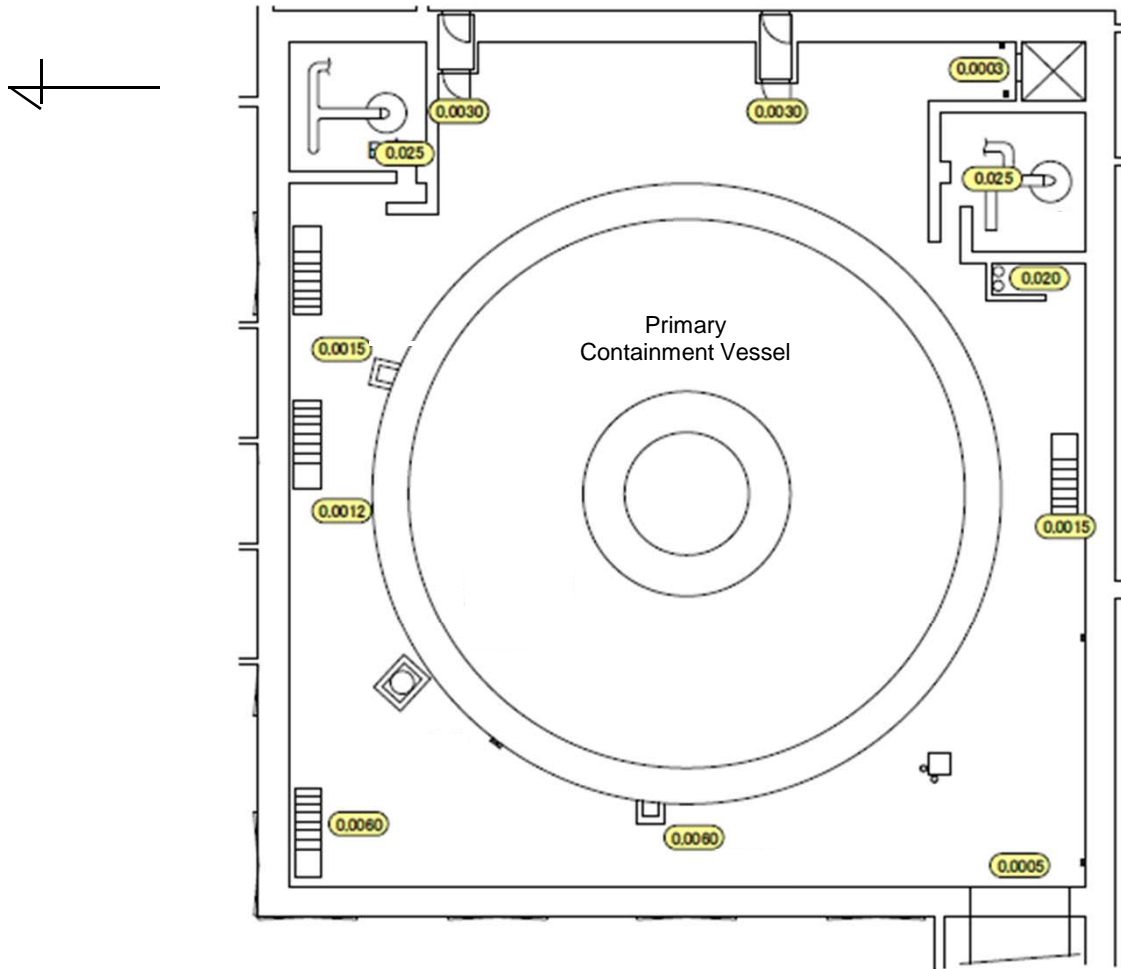

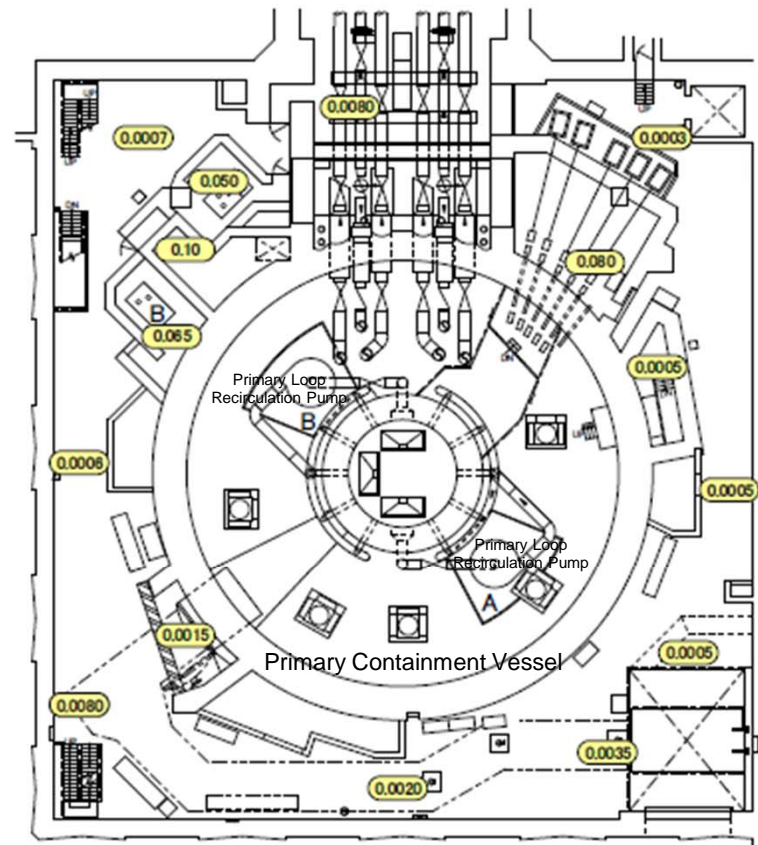
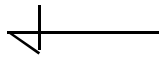

Fukushima Daiichi NPS

Unit 6 Reactor Building 3rd Floor

[mSv/h]

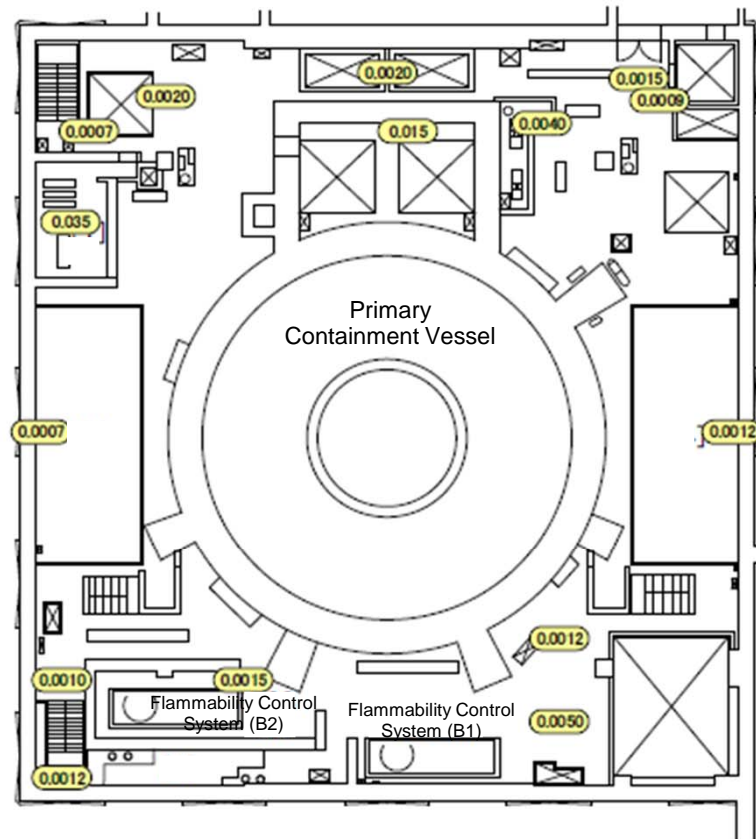
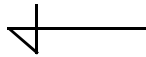

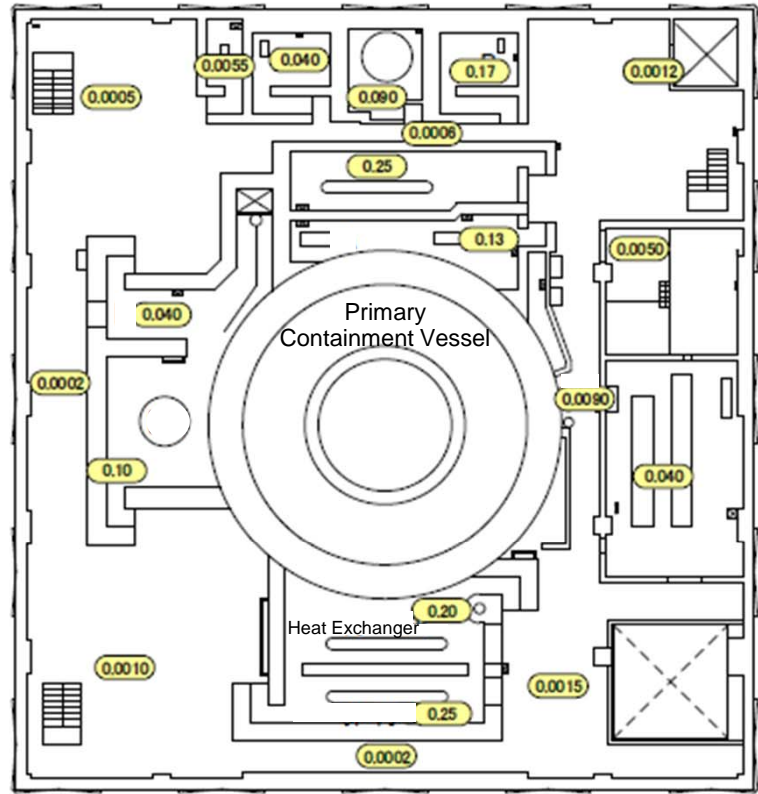
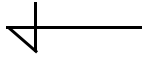

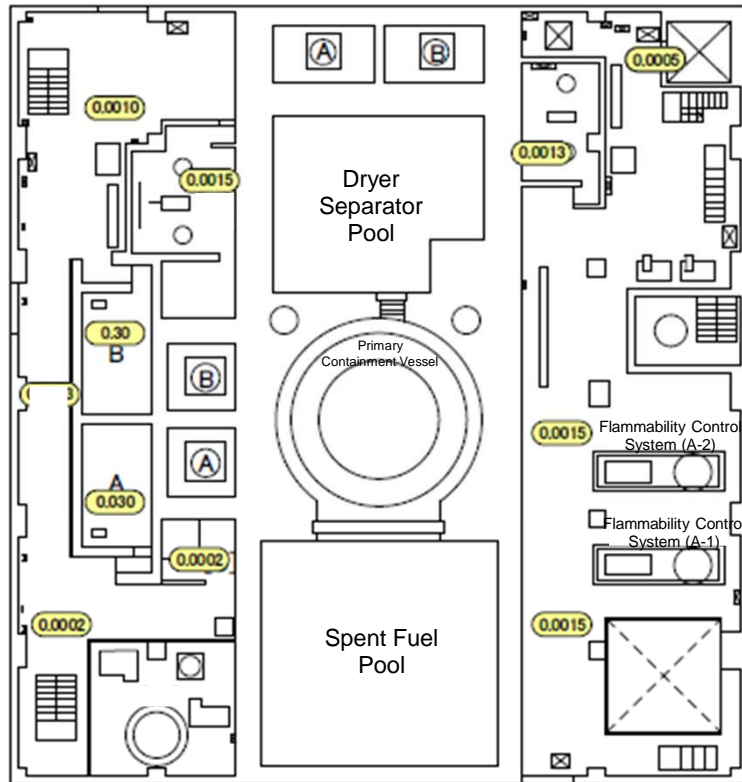
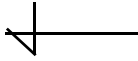

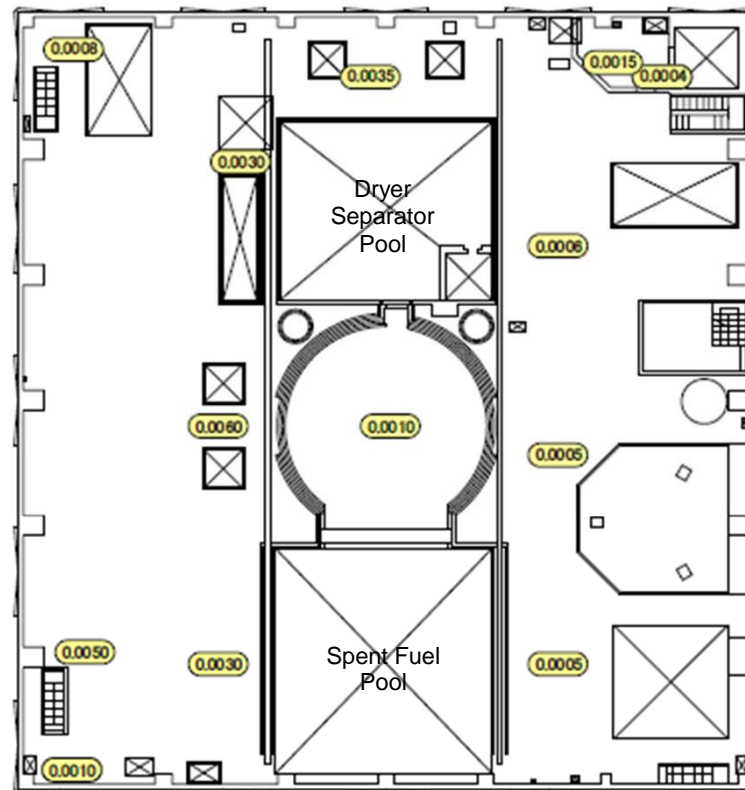
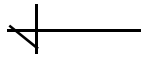

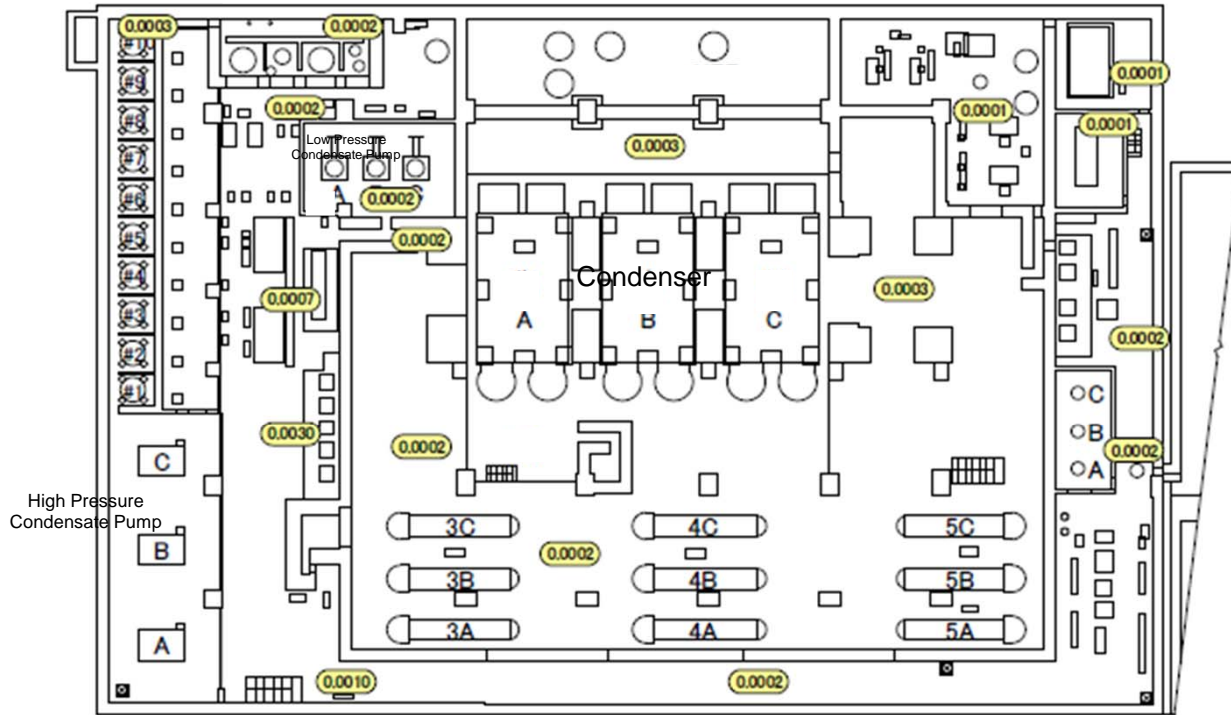
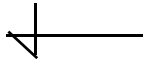

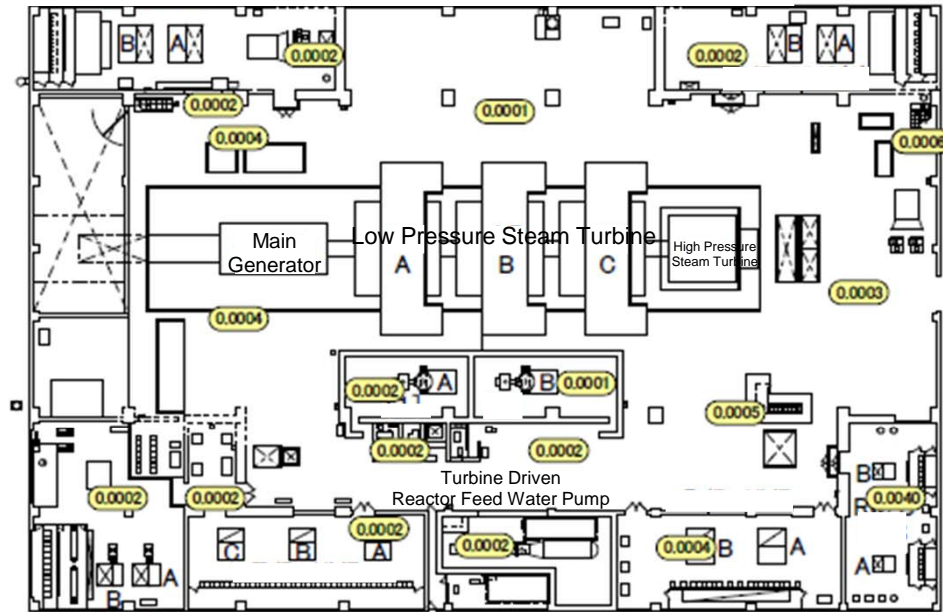
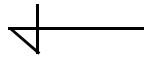

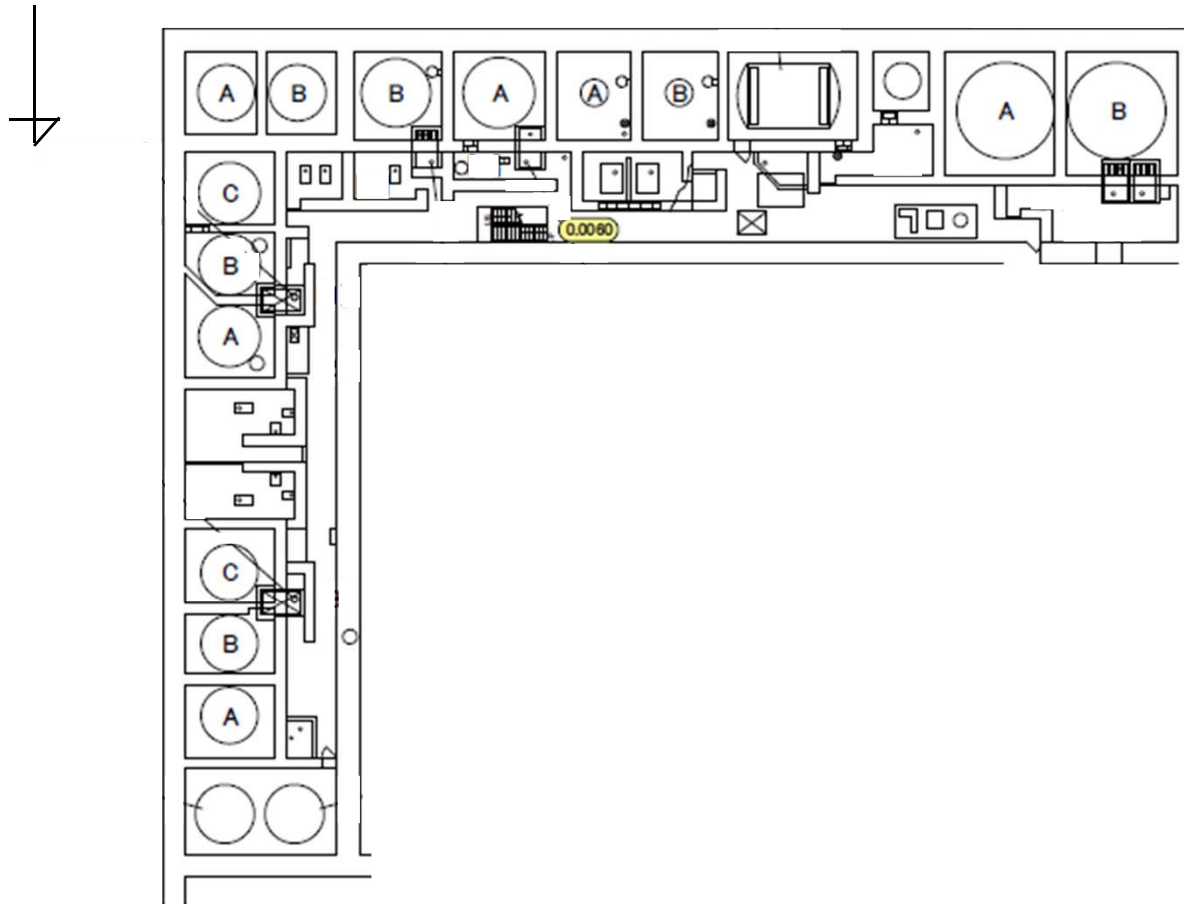

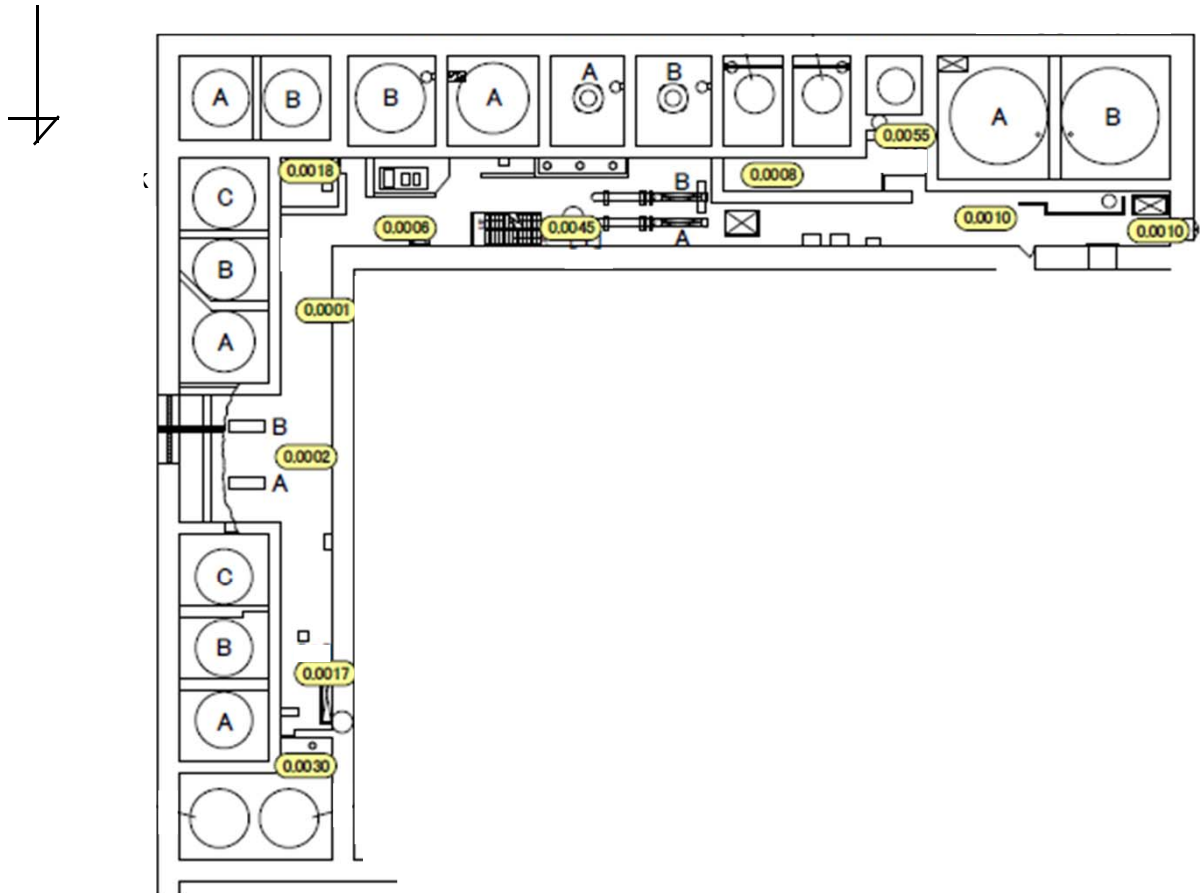

Fukushima Daiichi NPS

Unit 6 Radioactive Waste Treatment Facility Mezzanine Floor

[mSv/h]

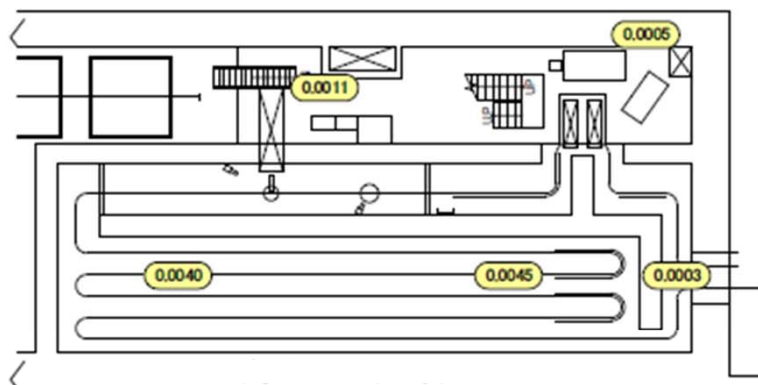

Fukushima Daiichi NPS

Unit 6 Radioactive Waste Treatment Facility 2nd Floor

[mSv/h]

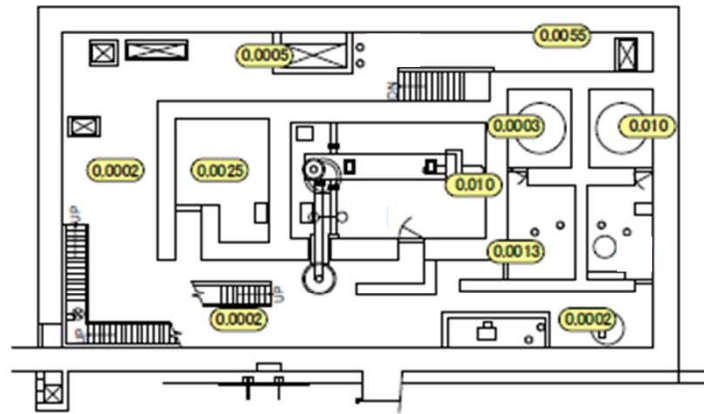

Fukushima Daiichi NPS

Unit 6 Radioactive Waste Treatment Facility 3rd Floor

[mSv/h]

