

February 29, 2016
Tokyo Electric Power Company

Air Dose Rates inside the Buildings

Sampling Period

Unit 5: from December 1, 2015 to December 31, 2015

Fukushima Daiichi NPS

Unit 5 Reactor Building 1st Basement Floor

[mSv/h]

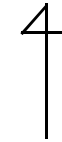
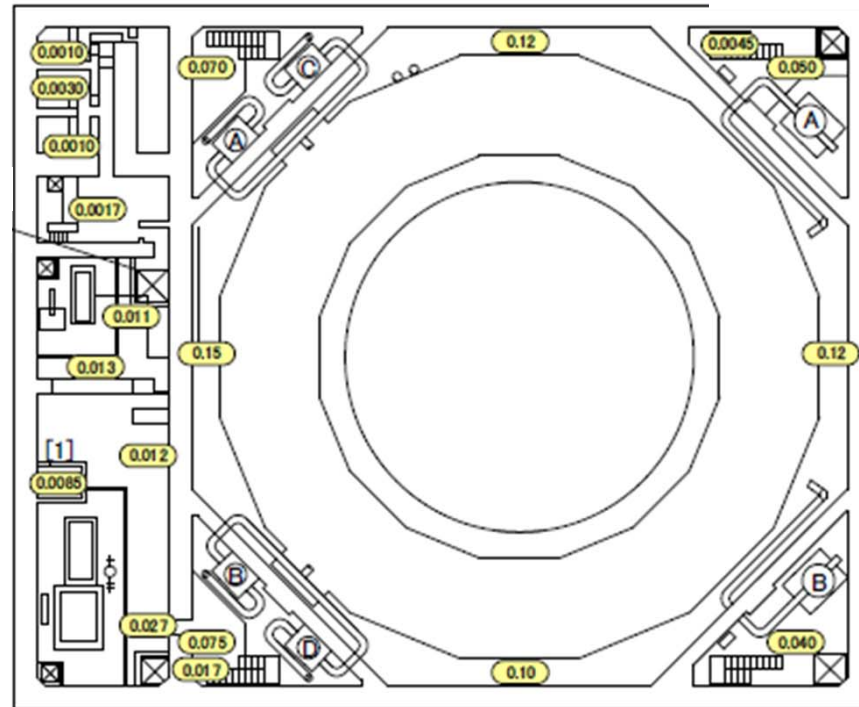

Fukushima Daiichi NPS	Unit 5 Reactor Building Semi-Basement Floor	[mSv/h]
-----------------------	---	---------

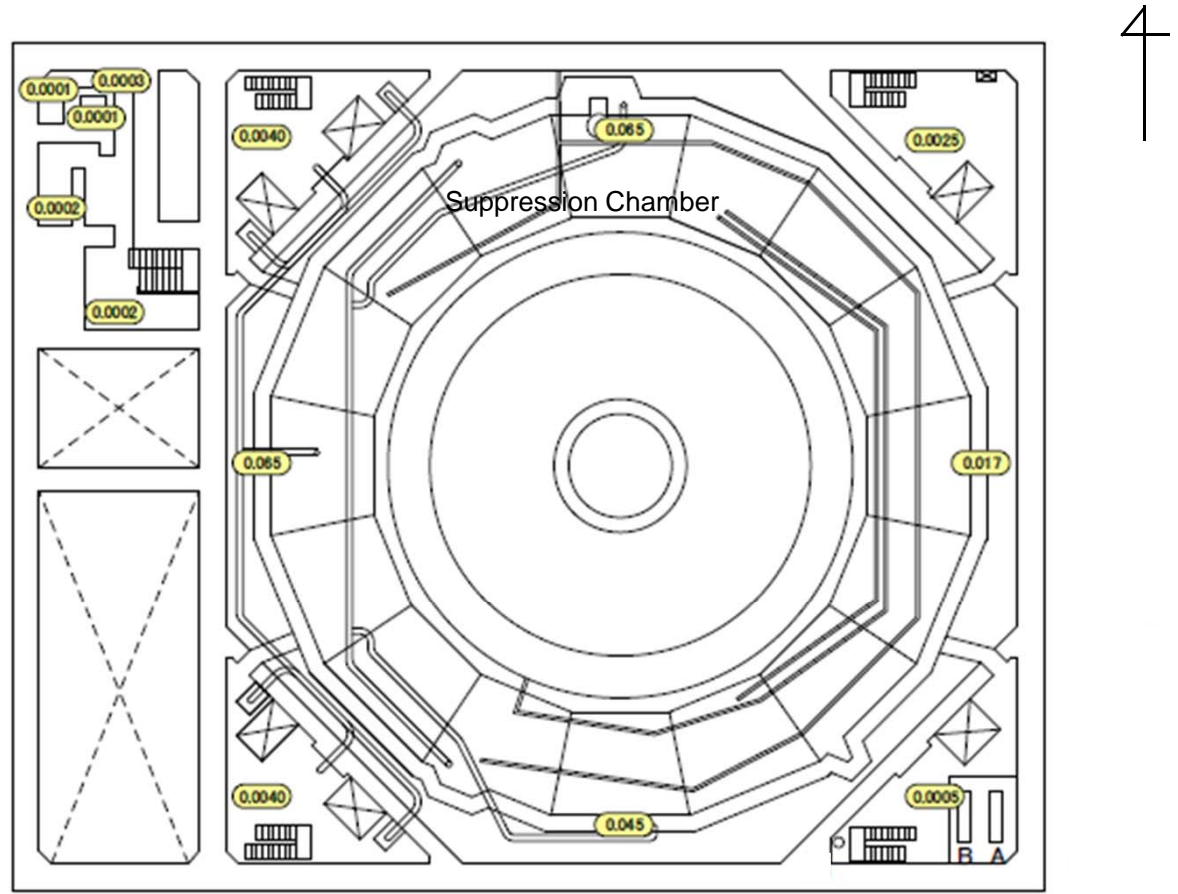

Fukushima Daiichi NPS	Unit 5 Reactor Building 1st Floor	[mSv/h]
-----------------------	-----------------------------------	---------

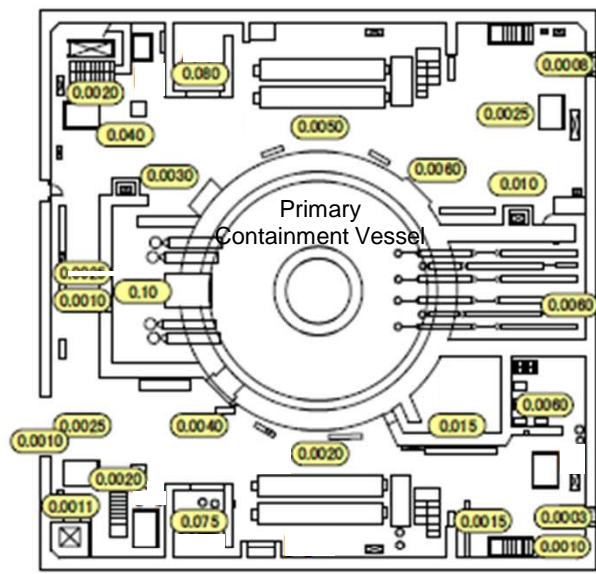

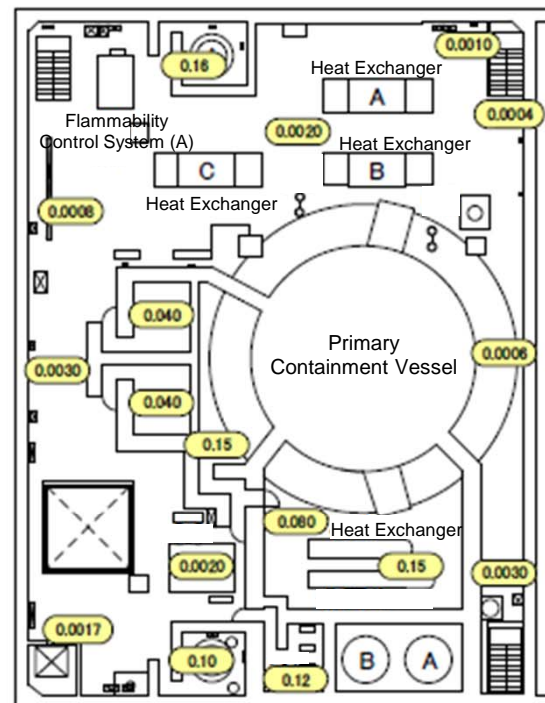

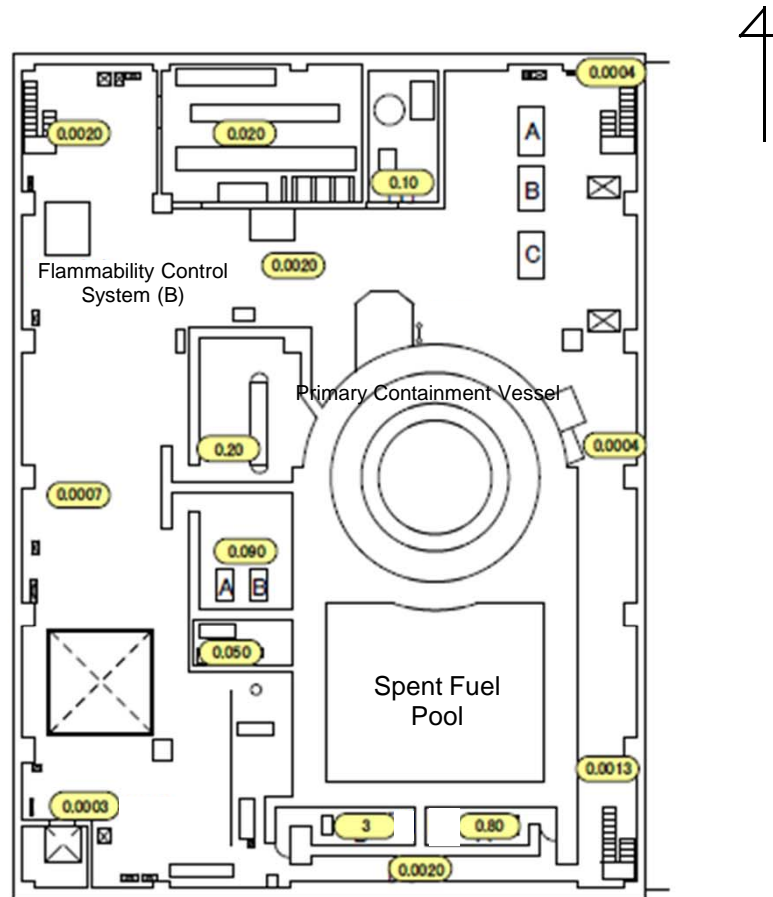

1F05RB004-00-01

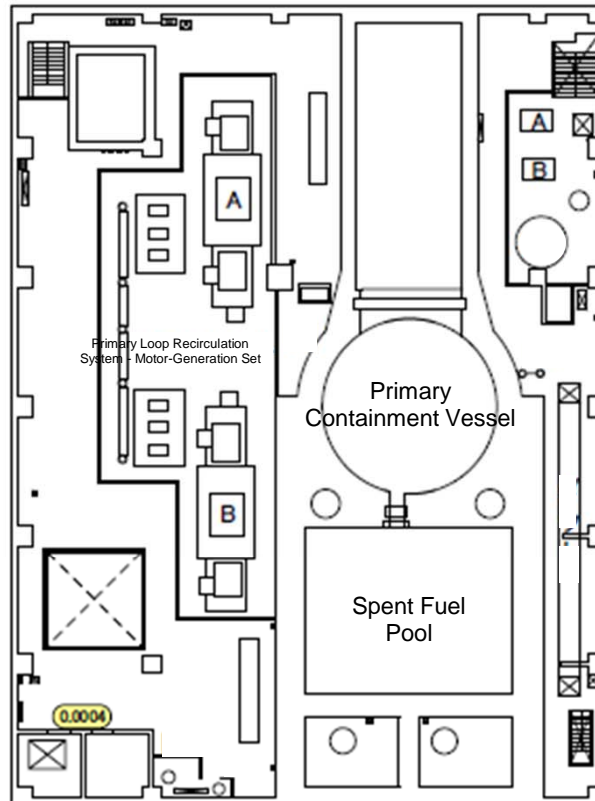
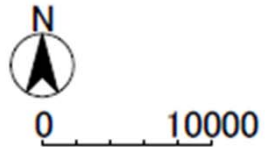

Fukushima Daiichi NPS	Unit 5 Reactor Building 5th Floor	[mSv/h]
-----------------------	-----------------------------------	---------

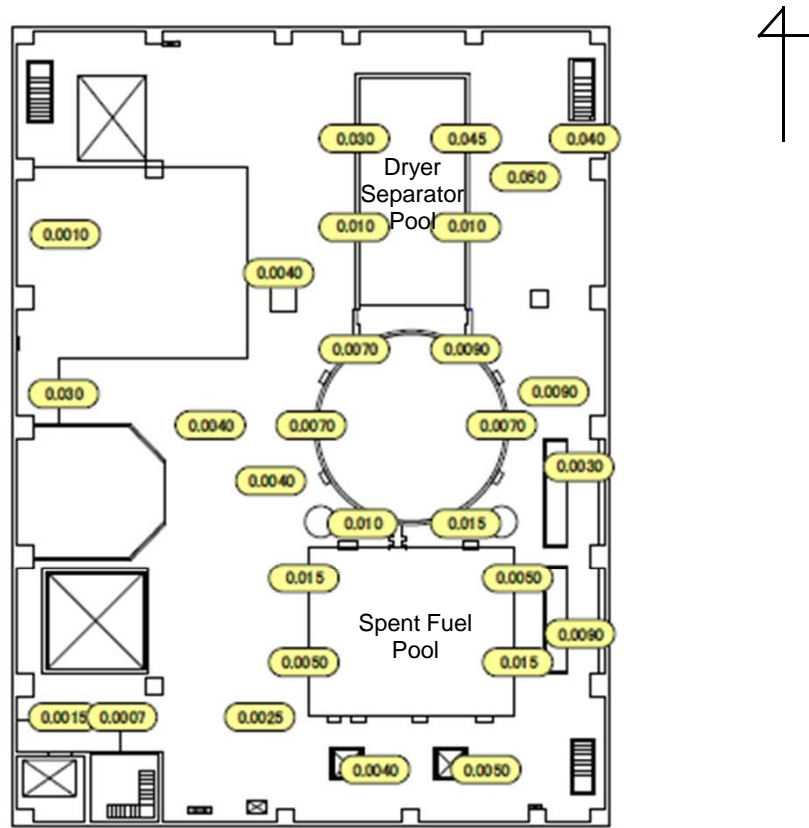

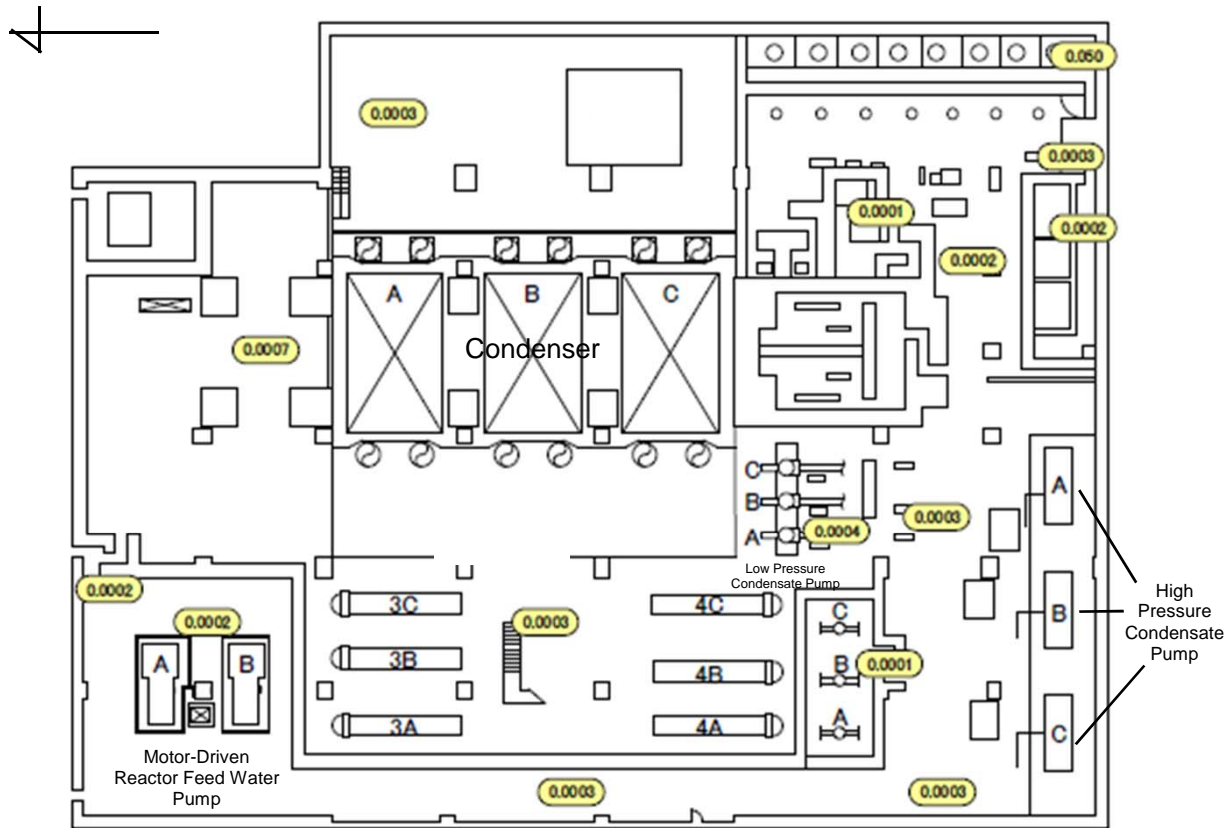

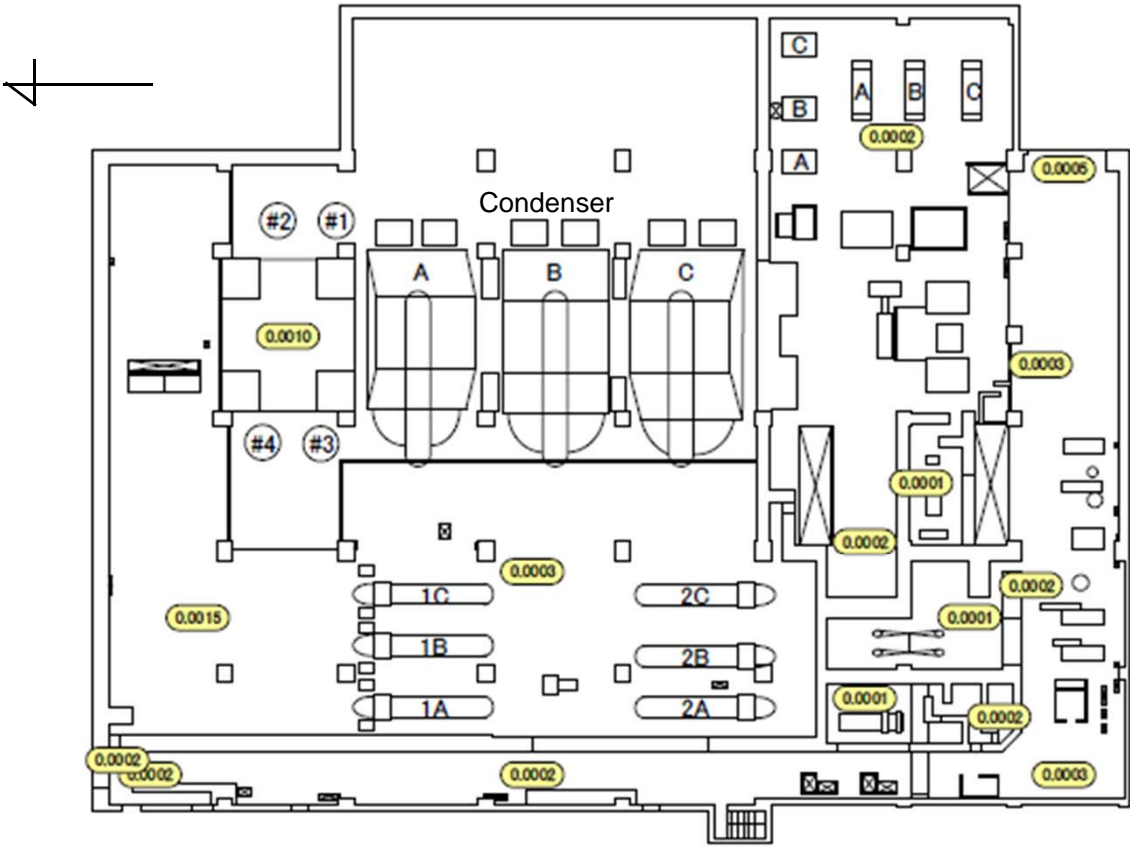

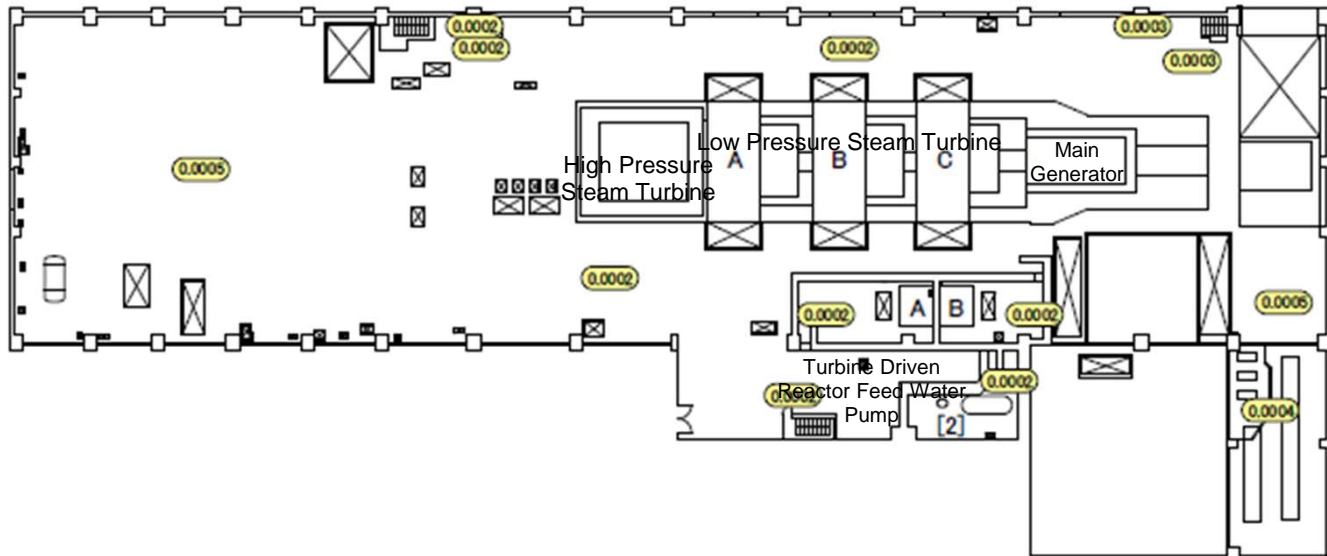
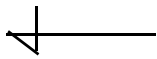

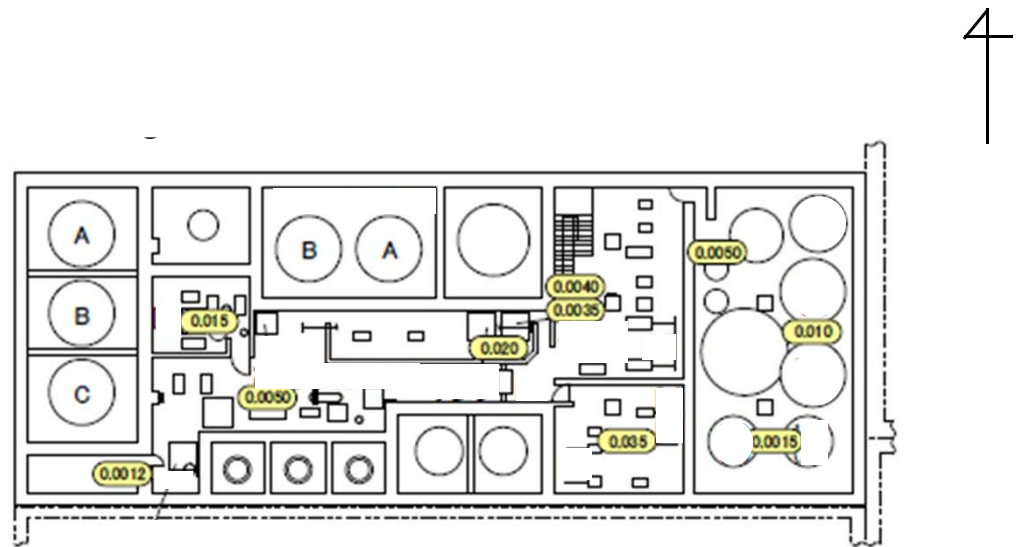

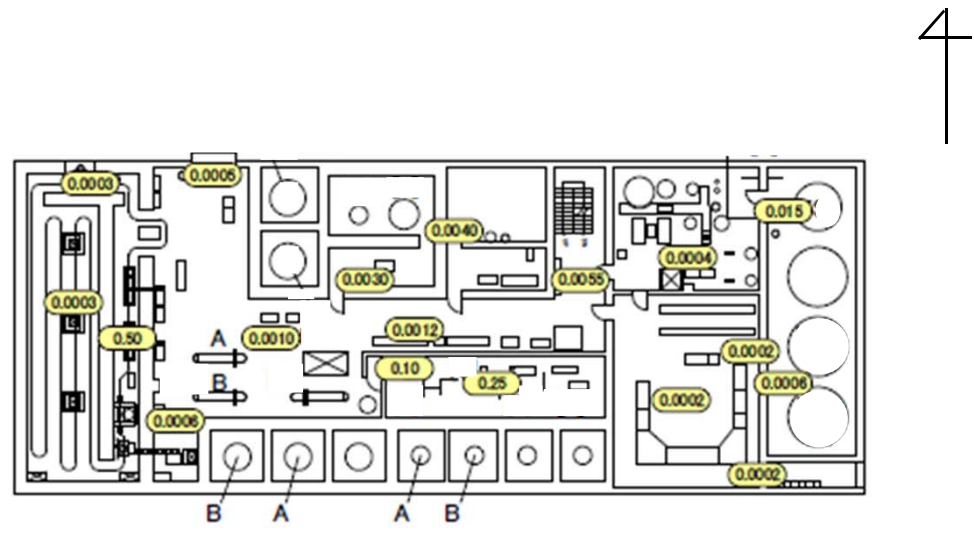

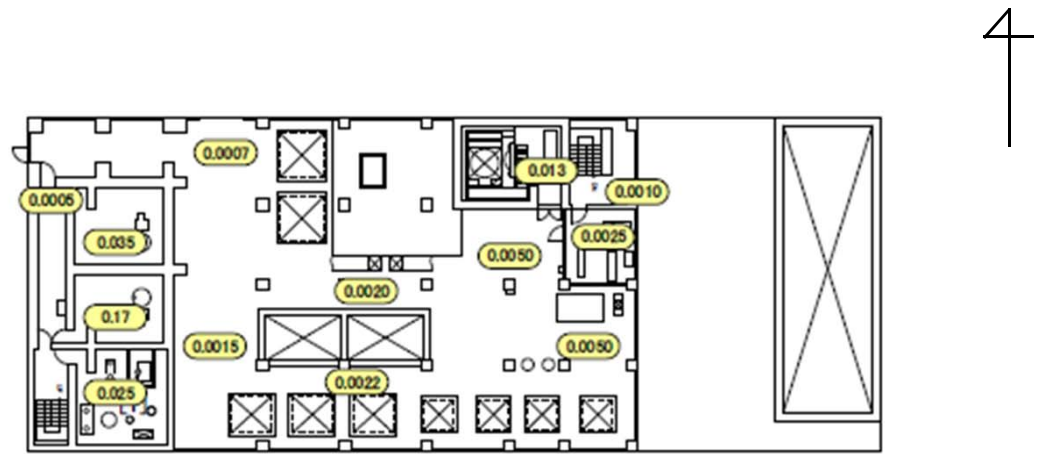

Fukushima Daiichi NPS	Unit 5 Radioactive Waste Treatment Facility 3rd Floor	[mSv/h]
-----------------------	---	---------

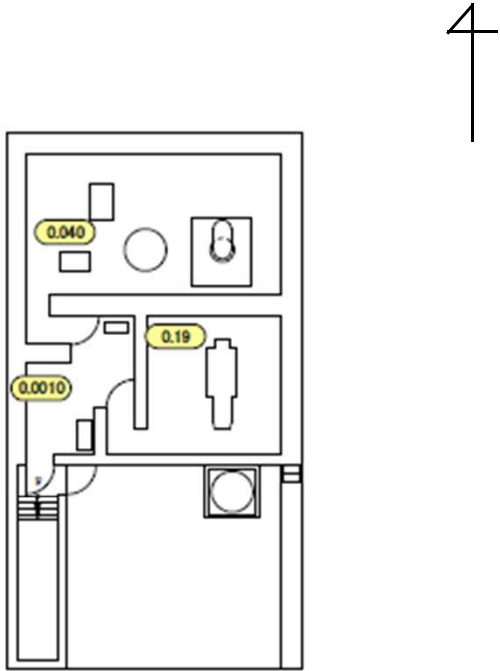

Fukushima Daiichi NPS	Units 5 and 6 Service Building 1st Floor	[mSv/h]
-----------------------	--	---------

