

Supplementary explanation on conformity to
the Items required for Measures which should
be taken at Tokyo Electric Power Co., Inc.'s
Fukushima Daiichi Nuclear Power Station in
line with the Designation as the Specified
Nuclear Facility

(Change in operation structure for the discharge
of ALPS treated water into the sea and selection
of nuclides to be measured and assessed)

December 2022

Tokyo Electric Power Company Holdings, Inc.

Table of Contents

Chapter 1 Security of the Specified Nuclear Facility

1.1 Conformity to the items required for measures which should be taken for security of the Specified Nuclear Facility.....	1-1
---	-----

Chapter 1 Security of the Specified Nuclear Facility

1.1 Conformity to the items required for measures which should be taken for security of the Specified Nuclear Facility

Items required for Measures which should be taken at Tokyo Electric Power Co., Inc.'s Fukushima Daiichi Nuclear Power Station in line with the Designation as the Specified Nuclear Facility (November 7, 2012, Decision of NRA Commission)
(Hereinafter referred to as "items required for measures.")

III. Items concerning Measures Taken for Security of the Specified Nuclear Facility

By taking appropriate measures such as operation management, maintenance management, radiation control, radioactive waste management, emergency measure and on-site and off-site environmental radiation monitoring, etc., "II. Items concerning Measures to be taken for Design and Facilities" shall be ensured to be appropriately and reliably implemented, and workers' and on-site and off-site safety shall be ensured.

Particularly, with regard to emergency measures during accident or disaster, systems for communication with organizations concerned and medical care in emergency shall be developed in addition to responses to emergency situation.

In addition, education and training shall be appropriately conducted for employees and workers including those of contracted and subcontracted companies to maintain and improve their skill and capability.

1.1 Policy to ensure conformity to items required for measures

For ALPS treated water dilution/discharge facilities and related facilities, appropriate measures such as operation control, maintenance management, radiation control, radioactive waste management, emergency measures and on-site and off-site environmental radiation monitoring, etc., will be implemented appropriately and reliably to ensure "II. Items concerning Measures to be taken for Design and Facilities" and to secure the safety of workers in and outside the premises.

1.2 Response policy

1.2.1 Operation structure for the discharge of ALPS treated water into the sea

Among the duties for the security of the ALPS treated water dilution/discharge facilities and related facility, the FDNPS organization performs the following duties. The designing, construction, installation and maintenance to ensure integrity are performed based on the Facility Management Plan.

- (1) The ALPS treated water Program Department performs **duties on** the planning and management of , and **study for the operation method of facilities related to the discharge of the water** which have been purified by Advance Liquid Processing System, etc., and **whose sum of ratios to regulatory concentration limit of radioactive materials other than tritium is less than 1 (hereinafter, referred to as ALPS treated water), the planning of operation for ALPS treated water dilution/ discharge facility,** and the duties on the design and construction/ installation of the mechanical and civil engineering SSCs related to those, among the safety assurance facilities of the Units 1 to 4. In addition, **the Department performs duties on planning ALPS treated water analyses.**
- (2) The Electrical Engineering Group performs duties on the design of electrical SSCs (excluding the duties performed by the Power Distribution and Electrical Circuit Group Manager.).
- (3) The Instrumentation Engineering Group performs duties on the design of instrumentation SSCs.
- (4) The Architectural Construction Engineering Group performs duties on the design of new buildings.
- (5) The Operation Shift Team (Water treatment System) performs **duties on the operation management of** contaminated water treatment facilities, buildings that store accumulated water, Advance Liquid Processing Systems, sub-drain etc. treatment facility (excluding groundwater drain collection facility,) and **the ALPS treated water dilution/ discharge facility** among the safety assurance facilities of the Units 1 to 4 (excluding the duties performed by the Operation Support Group Manager, the Work Management Group Manager and the Water Treatment Planning Group Manager.)
- (6) The Operation Support Group performs **duties on the part of the operation management, such as making manual and procedure and the facility management of the safety assurance facilities of the Units 1 to 4,** the Units 5/6, of the common spent fuel pool facility and the radioactive solid management facility and related facility (excluding miscellaneous solid waste incineration facility and additional miscellaneous solid waste incineration facility) among the others. In addition, the Group performs duties on the operation of water injection facility for RPV/ PCV (filtrate tanks, pure water tanks and raw water underground tanks) among the safety assurance facilities of the Units 1 to 4, and the radioactive solid management facility and related facility (miscellaneous solid waste incineration facility and additional miscellaneous solid waste incineration facility), large equipment decontamination facility and volume reduction facility among the safety

assurance facilities of the others.

- (7) The Water Storage Facility Group performs **duties on the maintenance management of civil engineering SSCs of contaminated water treatment facilities (water storage facility) and mechanical SSCs of the ALPS treated water dilution/ discharge facility**, and the construction/ installation and maintenance management of contaminated water treatment facilities (auxiliary facility of the water storage facility) and rain water treatment facility among the safety assurance facilities of the Units 1 to 4.
- (8) The Electrical Maintenance Group performs **duties on the maintenance management of electrical SSCs** and operation and maintenance management of power supply vehicles (excluding the duties performed by the Power Distribution and Electrical Circuit Group Manager and the Electrical Facility Construction Group Manager.)
- (9) The Electrical Facility Construction Group performs **duties on the construction/ installation management of electrical SSCs** (excluding the duties performed by the Power Distribution and Electrical Circuit Group Manager and the Electrical Facility Construction Group Manager.)
- (10) The Water Treatment Instrumentation Group performs **duties on the construction/ installation and maintenance management of instrumentation SSCs of** contaminated water treatment facilities, buildings that store accumulated water, Advance Liquid Processing Systems, sub-drain etc. treatment facility, oil treatment facility, water intake facility from Unit 3 PCV and **the ALPS treated water dilution/ discharge facility** among the safety assurance facilities of the Units 1 to 4, temporary facilities for Units 5/6 (accumulated water storage facility) among the safety assurance facilities of the Units 5/6, and the radioactive solid management facility and related facility, radioactive material analysis/ research center laboratory-1, large equipment decontamination facility and volume reduction facility among the safety assurance facilities of the others.
- (11) The Civil Infrastructure Group performs **duties on the construction/ installation and maintenance management of civil engineering SSCs** (excluding the duties performed by the general manager of each program department and group manager of each group other than the Civil Infrastructure Group Manager.).
- (12) The Architectural Facility Maintenance Group performs **duties on the maintenance management of buildings** (excluding the duties performed by the general manager of each program department and group manager of each group other than the Architectural Facility Group Manager.) In addition, the group performs duties on the maintenance management of electrical SSCs of large equipment decontamination facility among the safety assurance facilities of the others.
- (13) The Architectural Facility Construction Group performs **duties on the construction/ installation management of buildings** (excluding the duties performed by the general manager of each program department and group manager of each group other than the Architectural Facility Construction Group Manager.)

- (14) The Release and Environment Monitoring Group performs **duties on** on-site and off-site land and sea area environmental monitoring among radiation control, and **liquid waste discharge control** and measurement and release management of gaseous waste from Units 1 to 4 reactors, and radioactive gaseous waste release management from Units 5 and 6 **among radioactive waste management**.

- (15) The Chemical Analysis & Evaluation Group carries performs **duties on** the operation of analysis facilities, management of radiation and chemical analysis equipment, operation and maintenance management of radioactive material analysis/ research center laboratory-1, and **analysis/data assessment**.

1.2.2 Selection of nuclides to be measured and assessed at the discharge of ALPS treated water to the sea

(1) Overview

With regard to radionuclides other than tritium in ALPS treated water, the result of the analysis of the radioactivity concentrations of the seven major nuclides* plus carbon 14 and technetium 99 in ALPS treated water, and the measured value of gross β shows no discrepancies that would raise suspicion regarding radionuclides except for radionuclides of the current 64 nuclides. In addition, some of the nuclides subject to removal by ALPS will be considered sufficiently decayed and become less abundant by the time of the discharge of ALPS treated water into the sea. Therefore, the sum of the ratios to regulatory concentration limits is considered to satisfy less than 1.

In order to ensure that the sum of the ratios to regulatory concentration limits is less than 1, target nuclides to be measured and assessed (hereinafter "nuclides to be measured and assessed") are selected after thorough verification whether they are significantly present in contaminated water based on domestic knowledge of decommissioning and disposal facilities.

Given that, in order to ensure the sum of the ratios to regulatory concentration limits of less than 1, thorough verifications will be performed, while taking into account previous studies on decommissioning and burial facilities in Japan, to check for significant presence of nuclides in the contaminated water. Then radionuclides to be measured and assessed (hereinafter referred to as nuclides to be measured and assessed) will be selected.

*: ALPS has a processing performance that can remove 62 nuclides until the sum of the ratios to regulatory concentration limits becomes below 1. Even so, since it would take a long time to analyze all of the 62 nuclides, it was necessary to select representative nuclides to confirm the performance of ALPS and to understand the concentration of nuclides contained in tanks without causing a delay in the decommissioning work. At that time, 62 nuclides in the treated water were analyzed, and the 7 nuclides that were detected at significant concentrations compared to the regulatory concentration limits are called major 7 nuclides (Cs-134, Cs-137, Sr-90, I-129, Co-60, Sb-125, Ru-106).

(2) Policy on the selection of nuclides to be measured and assessed

For verification of nuclides which have possibility to be significantly contained in contaminated water at FDNPS, nuclide analyses are conducted based on the domestic knowledge on decommissioning and disposal facilities, and inventory assessments are conducted.

Nuclide analysis
Verify whether or not the nuclides to be assessed in the research on decommissioning and disposal facilities are also significantly present in contaminated water by actual analysis of water. Also verify the results of past nuclide analyses.
Inventory assessment
Assess an inventory of fission products in the same way as in the study of nuclides subject to removal by ALPS. Assess the inventory quantity generated by activation of such as structures in reactor pressure vessel based on the studies on decommissioning and disposal facilities. In the above assessments, taken into account the reduction of inventory quantity due to decay as the 12 years have passed since the earthquake until discharge. Based on the above assessment results, verify the existence of nuclides that may be significantly contained in contaminated water, taking into account such as the ease of transfer to water.

Based on the results of nuclide analysis and inventory assessment, the nuclides to be measured and assessed are selected, taking into account the impacts on dose assessment.

- (3) Selection of nuclides to be measured and assessed at the time of the discharge of ALPS treated water into the sea
- a. Rational behind the selection of nuclides subject to be measured and assessed for discharge of ALPS treated water into the sea

Based on the results of nuclide analysis and inventory assessment in section (2), the nuclides to be measured and assessed are selected according to the flowchart, shown in Figure-1.1-1

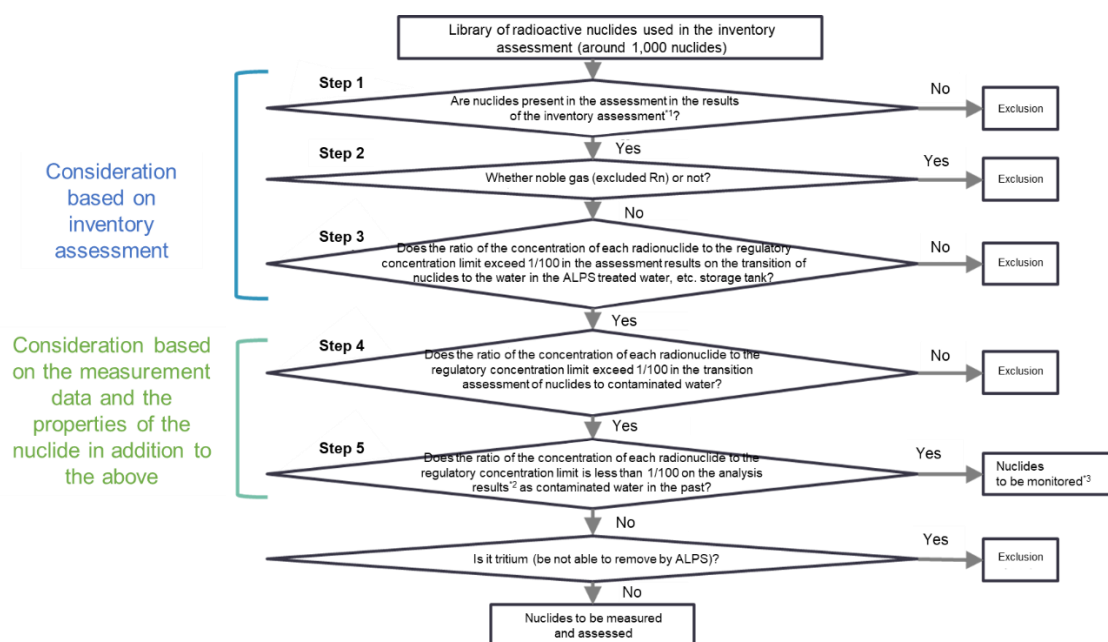

*1: The decay period of the inventory evaluation is appropriately set according to the time when the selection result is to be used. (First time set to 2023 (12 years after the accident))

*2: Nuclides that have been detected in the past are confirmed by the maximum value of the detection value, and nuclides that have never been detected are confirmed by the minimum value of the detection limit value

*3: Nuclides that shall be continuously confirmed if significantly exists in contaminated water.

Figure 1.1-1 Flow for selecting nuclides to be measured and assessed at the discharge of ALPS treated water to the sea

b. Confirmation of discharge criterion

Before discharging ALPS treated water into the sea, it will be confirmed that the nuclides selected for measurement and assessment based on the flowchart in Figure-1.1-1 satisfy the discharge criteria (sum of the ratios to regulatory concentration limit of nuclides other than tritium is less than 1.)

c. Regular confirmation of nuclides to be measured and assessed

These nuclides to be measured and assessed are selected based on the flowchart in Figure-1.1-1. However, there is a possibility that the situation may change depending on the progress of the decommissioning work in the future. Therefore, the following methods are used to confirm that there are no significant nuclides other than the selected nuclides to be measured and assessed (hereinafter "other nuclides"). If it is confirmed that other nuclides are significantly present (1/100 or more of the regulatory concentration limit) during this confirmation process, re-assessment of the nuclides to be measured and assessed will be performed. The decay of radionuclides will be also reflected in the selection flowchart.

(a) Confirmation of each discharge

When confirming that ALPS treated water meets the discharge limit, also confirm that no other nuclides are present significantly by measuring with gross α , gross β , and Ge semi-conductor detectors.

(b) Trend confirmation in contaminated water

Confirm that concentrations of radionuclides, regularly checked in contaminated water of downstream from the centralized radioactive waste building, are below the previously confirmed concentration and there is no change in the status of the transfer of radionuclides to contaminated water.

(c) Investigation analysis

The existence of other nuclides is investigated when an event with concern is confirmed in the sections (a) and (b). Even if such concerns are dispelled, check the presence of the nuclides subject to be monitored in contaminated water prior to ALPS treatment at a frequency of once a year in order to investigate the presence of other nuclides.

Supplementary explanation on the change in operation system for the discharge of ALPS treated water into the sea

1. Overview

When the application for the change to the Implementation Plan concerning the establishment of the ALPS Treated Water Program Department was filed, it was planned to submit a separate application regarding the operation system for the running and maintenance of the ALPS treated water discharge. This time, the system has been concretized, and the details of the change are explained herein. Figure 1.1.1-1 shows the scope of the last application for the Implementation Plan and that of the application this time.

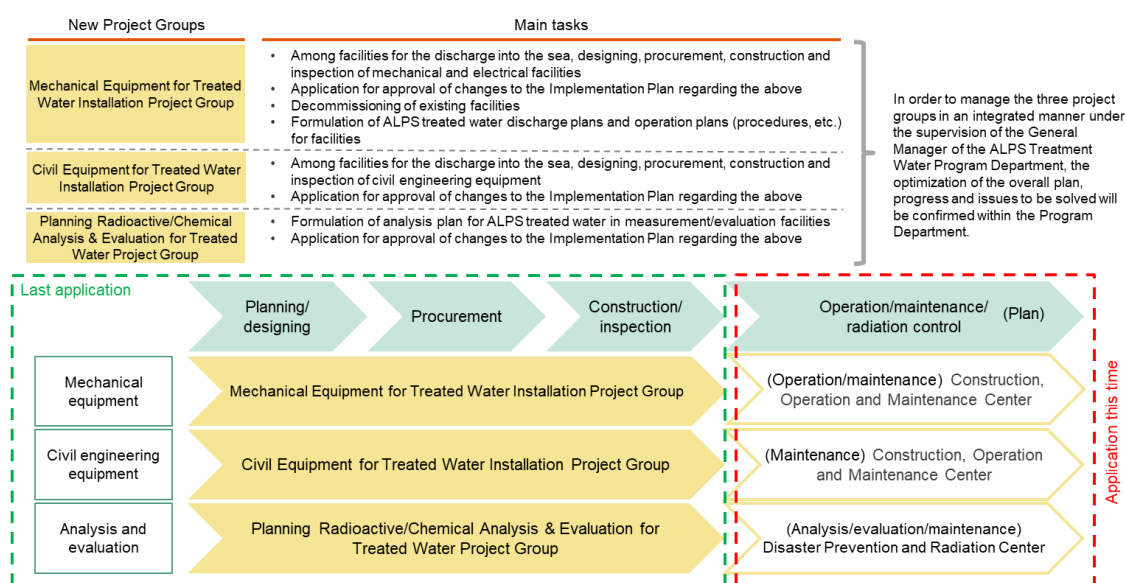

Figure 1.1.1-1 Organizations responsible for the discharge of ALPS treated water into the sea

2. Organizational structure for the discharge of ALPS treated water into the sea

Fig. 1.1.1-2 shows the organizational structure for discharging ALPS treated water into the sea based on the organization chart of Fukushima Daiichi Decontamination and Decommissioning Engineering Company. This section describes the duties performed by each group.

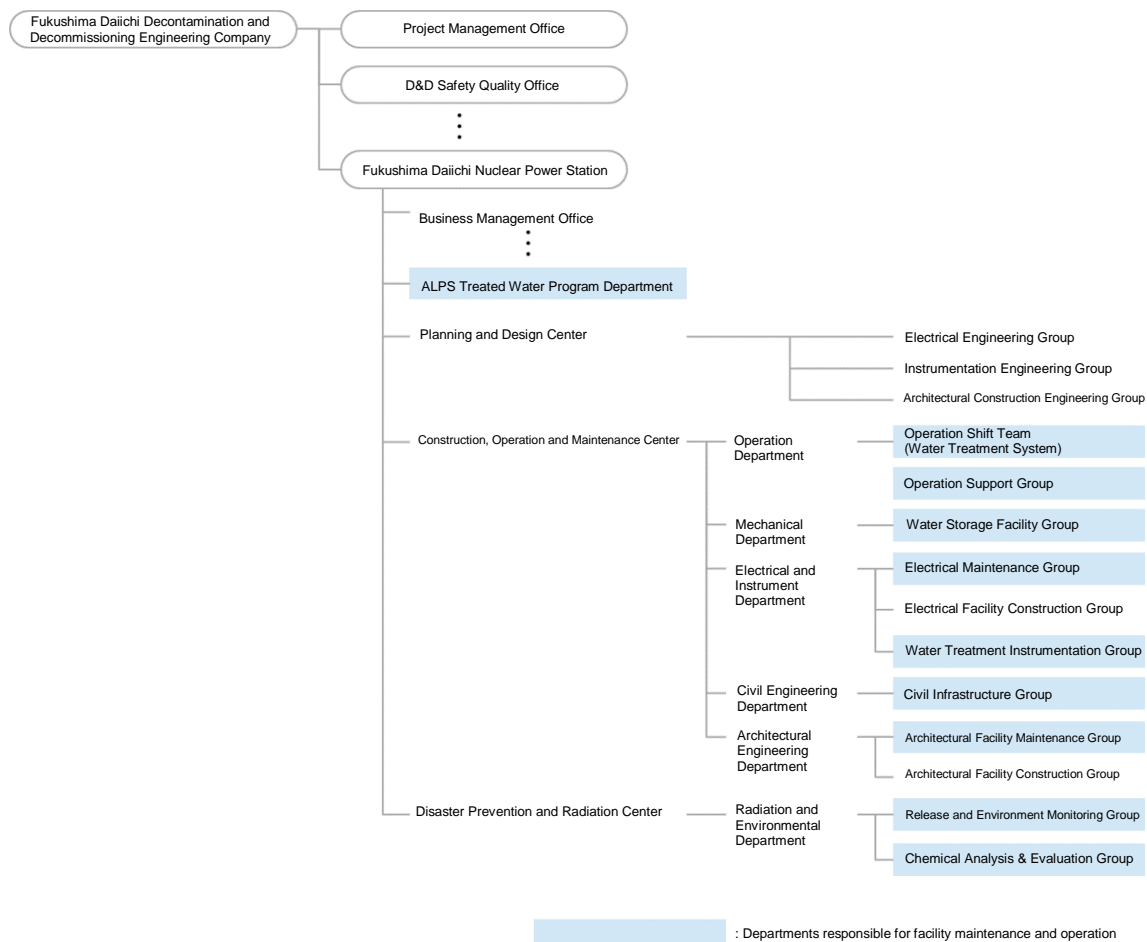

Figure 1.1.1-2 Organization chart for discharging ALPS treated water into the sea at Fukushima Daiichi Decontamination and Decommissioning Engineering Company

2.1 Designing, construction/installation, maintenance management system

As for designing, construction, and installation of the ALPS treated water dilution/discharge facilities and related facilities, the ALPS Treated Water Program Department had been in charge of the management of projects (process management, budgetary management, and risk management). The ALPS Treated Water Program Department had also been responsible for daily tasks associated with mechanical equipment and civil engineering equipment. Other daily tasks associated with electrical equipment, instrumentation and construction facilities had been entrusted to the Planning and Design Center and the Construction, Operation and Maintenance Center.

After the start of operation, the maintenance management of facilities will be performed by the Construction, Operation and Maintenance Center as shown in Table 1.1.1-1. Table 1.1.1-2 shows the specific maintenance targets of each facility.

Table 1.1.1-1 Organizations responsible for the designing, construction/installation, and maintenance management of ALPS treated water dilution/discharge facilities and related facilities

Facilities	Last application		Application this time
	Designing	Construction and installation	Maintenance management
Mechanical equipment	ALPS Treated Water Program Department		Water Storage Facility Group
Civil engineering equipment	ALPS Treated Water Program Department		Civil Infrastructure Group
Electrical facilities	Electrical Engineering Group	Electrical Facility Construction Group	Electrical Maintenance Group
Instrumentation	Instrumentation Engineering Group	Water Treatment Instrumentation Group	Water Treatment Instrumentation Group
Construction facilities	Architectural Facility Construction Group	Architectural Facility Construction Group	Architectural Facility Maintenance Group

Planning and Design Center
Construction, Operation and Maintenance Center

*: The sections written in red are the changes to the Implementation Plan for which the application was filed this time.

Table 1.1.1-2 Main maintenance and management targets for ALPS treated water dilution/discharge facilities and related facilities

Facilities	Mechanical SSCs	Civil engineering SSCs	Electrical SSCs
Main maintenance management target	<ul style="list-style-type: none"> • Circulation pump (excluding motor) • Agitation equipment • Measurement/confirmation tanks • ALPS treated water transfer pump (excluding motor) • Emergency isolation valve-1, 2 • Water flow rate control valve for ALPS treated water • Seawater transfer pump (excluding motor) • Main pipe (including seawater pipe header) 	<ul style="list-style-type: none"> • Discharge vertical shaft (upper-stream storage/down-stream storage) • Discharge tunnel • Discharge outlet 	<ul style="list-style-type: none"> • Power panel • Circulation pump (motor) • ALPS treated water transfer pump (motor) • Seawater transfer pump (motor)
Facilities	Instrumentation SSCs	Buildings	
Main maintenance management target	<ul style="list-style-type: none"> • Monitoring and control device • ALPS treated water flowmeter • Radiation monitor • Seawater flowmeter 	<ul style="list-style-type: none"> • Electrical equipment building on east of Units 5 and 6 	

2.2 Facility operation management system

As for the operation control of the ALPS treated water dilution/discharge facilities, the ALPS Treated Water Program Division reviews the operation method at present. Once the operation starts, the Construction, Operation and Maintenance Center will take charge of the operation control as shown in Table 1.1.1-3 and the ALPS Treated Water Program Division the planning of operation. Since the release of small amounts at the initial stage of discharge into the sea is different from the normal operation, the work is implemented as the ALPS Treated Water Program Department, which is in charge of discharge management, charges the Operation Shift Team (Water Treatment System) with the operation management. After that, the task will be carried out in accordance with the organizations responsible in the following table.

Table 1.1.1-3 Organizations responsible for operation control of ALPS treated water dilution/discharge facilities

Tasks	Last application	Application this time
	Design stage	After the start of operation
Review of operation methods Study on the method for discharging ALPS treated water into the sea (e.g., confirmation of discharge standards prior to dilution and discharge, ensuring that it is less than 1500 Bq/L of H-3 concentration, etc.)	ALPS Treated Water Program Department	
Operation plan Release plan development for ALPS treated water and establishment of facility operation plan for the execution of the plan.	-	ALPS Treated Water Program Department
Operation management Duties related to the operation of ALPS treated water dilution/release facilities and facility condition management	-	Operation Shift Team (Water Treatment System)
Duties associated with manuals and procedures among the operation management Duties related to establishing and revising the manuals and procedures in operation management of ALPS treated water dilution/discharge facilities	-	Operation Support Group

Construction, Operation and Maintenance Center

*: The sections written in red are the changes to the Implementation Plan for which the application was filed this time.

2.3 Tasks associated with analyses for the discharge of ALPS treated water into the sea
 As for tasks associated with analyses for the discharge of ALPS treated water into the sea, the ALPS Treated Water Program Division is in charge of planning of analyses at present. Once the operation starts, as is the case with tasks associated with other analyses, the Disaster Prevention and Radiation Center will take charge of the analysis/data evaluation, discharge control of liquid waste, etc. as shown in Table 1.1.1-4.

Table 1.1.1-4 Organizations responsible for the analysis of ALPS treated water

Tasks	Last application	Application this time
	Planning stage	After the start of operation *1
Analysis plan	ALPS Treated Water Program Department	
Analysis/data evaluation	-	Chemical Analysis & Evaluation Group
Discharge control of liquid waste, etc.	-	Release and Environment Monitoring Group

Disaster Prevention and Radiation Center

Here, the detailed operation flow for the analysis of the ALPS treated water is shown in Figure 1.1.1-3, and the task from the analysis to the release is all planned to be carried out in the chemical management system. Among them, the Chemical Analysis & Evaluation Group performs the tasks related to the analysis and data evaluation of ALPS treated water, and the Release and Environment Monitoring Group, which receives the notification of the analysis result via the chemical management system, determines whether to discharge or not. When the discharge standard is satisfied, the Release and Environment Monitoring Group notifies the effluent analysis result to Shift Team for Water Treatment, and the facility operation for the discharge is carried out.

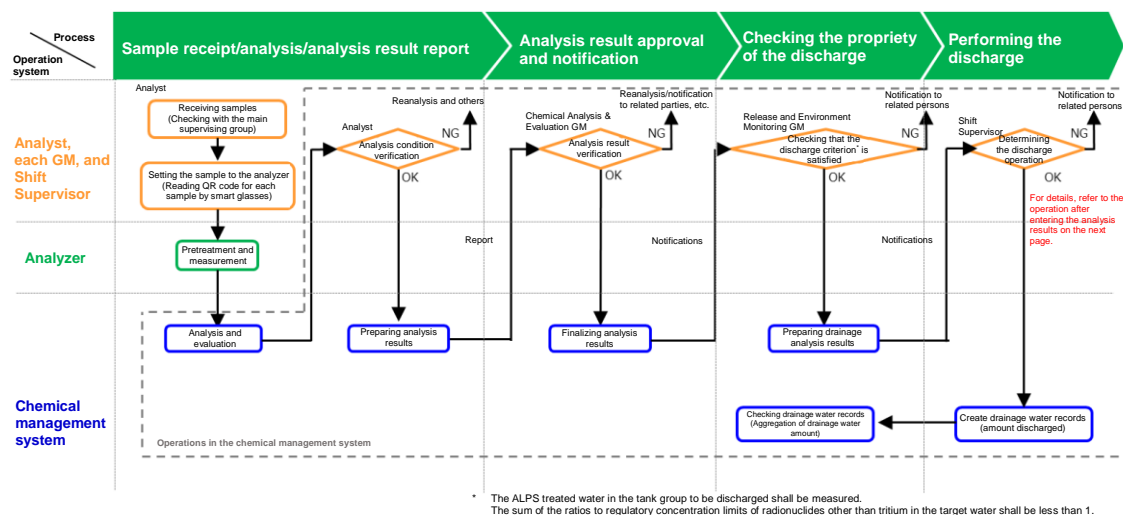

Figure 1.1.1-3 Analysis process

1.1.1-5

Supplementary explanation on securing personnel
for Operation Shift Team (Water Treatment System)

1. Overview

Currently, Operation Shift Team (Water Treatment system) is operated by 5 teams with 8 persons per team on 2 shifts system.

We expect to have additional duties associated with the discharge of ALPS treated water into the sea, as shown in Table 1.1.1-5. For transferring operation management-related duties, the structure will be a total of 10 persons per team (+2 persons per team).

Table 1.1.1-5 Additional duties related to operation management of
ALPS treated water discharge facilities

Main additional duties		Number of additional members
Facility condition management	Parameter monitoring, data collection, and field patrols	+2 persons per team
Response to alarm issuance	Verification of site conditions at the time of alarm issuance	
PTW operations	Operation such as isolating field valves	
Transfer pump, seawater transfer pump start/stop operation	On-site check when starting/stopping	
	Field lineup	

2. Proposed changes to the framework of the Shift Team for Water Treatment

The framework of the Shift Team for Water Treatment as of November 2022 is shown in Figure 1.1.1-4. In addition to stagnant water transfer facility, cesium adsorption facilities (SARRY/SARRY II/KURION), desalination facilities (existing RO, RO in the building), and three multi-nuclide removal facilities (ALPS), Operation Shift Team (Water Treatment System) is in charge of operation management of sub-drain, groundwater bypass, storage tanks for ALPS treated water, etc., and land-side impermeable walls. From the viewpoint of the integrated management of the water treatment facilities, the Operation Shift Team (Water Treatment System) also provides operation management of the ALPS treated water discharge facilities into the sea. An increase of 2 persons per team is planned for the Operation Shift Team members to ensure that operation management can be performed after the addition of the ALPS treated water discharge facilities.

The fixed number of regular personnel of the Operation Shift Team (Water Treatment System) is determined to be 8 persons per team in the secondary manual "QI-51-1 Manual for securing operators", and when the fixed number of regular personnel is changed (10 persons per team), the secondary manual "QI-51-1 Manual for securing operators" will be revised.

In improving the framework, we are working on training the personnel assigned to the Operation

Department to ensure the competence of operators. We are securing the personnel systematically by first ensuring sufficient competence to serve as an operator.

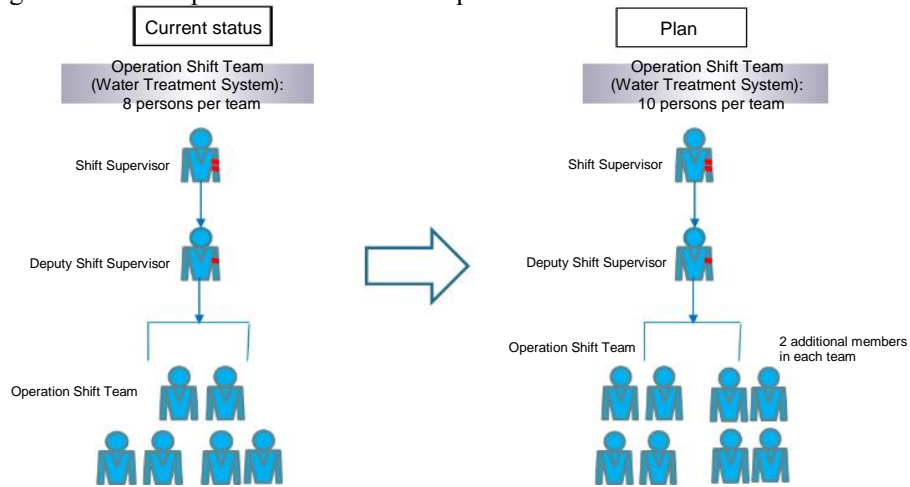

Figure 1.1.1-4 Framework of Operation Shift Team (Water Treatment System)

Supplementary explanation on the nuclide analysis in the examination of nuclides to be measured and assessed at the discharge of ALPS treated water into the sea

1. Overview

In order to ensure that the sum of the ratios to regulatory concentration limits of radionuclides other than tritium in ALPS treated water is less than 1, thorough verifications will be performed, while taking into account previous studies on decommissioning and burial facilities in Japan, to check for significant presence of nuclides in the contaminated water. Then radionuclides to be measured and assessed (hereinafter referred to as nuclides to be measured and assessed) will be selected. The examination will be carried out in accordance with the flow explained at the 9th Review Meeting on the Implementation Plan Regarding the Handling of ALPS Treated Water (See Figure 1.1.2-1), and a nuclide analysis and inventory assessment are planned to be performed. This document supplements the explanation about the nuclide analysis.

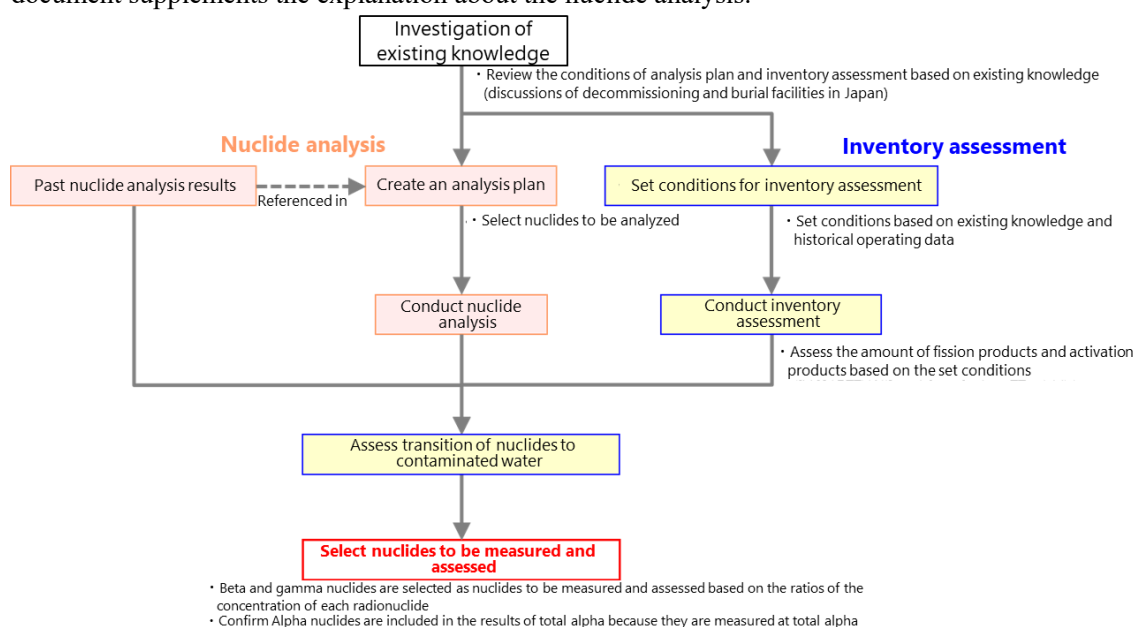

Figure 1.1.2-1 Overall procedure for examining the selection of the nuclides to be measured and assessed
 [Excerpt from a document for the 9th Review Meeting on the Implementation Plan Regarding the Handling of ALPS Treated Water (partially revised)]

2. Nuclide analysis

2.1 Survey of past analysis results

[Excerpt from the Supplementary Explanation of the Implementation Plan for the ALPS Treated Water Dilution/Discharge Facilities and Related Facilities (July 2022)]

So far, Japan Atomic Energy Agency (hereinafter referred to as JAEA) and TEPCO have analyzed 20 nuclides except for the nuclides (62 nuclides) to be removed by ALPS, tritium, and C-14 as shown in Table 1.1.2-1.

A nuclide analysis plan has been laid out for examining the selection of nuclides to be measured and assessed, and in developing this plan, the results of past analyses were taken into account as well as previous studies to select nuclides subject to the nuclide analysis (hereinafter referred to as “nuclides to be analyzed”).

Table 1.1.2-1 List of nuclides analyzed in the past

Fission products (56 nuclides)						
Rb-86	Sr-89	Sr-90	Y-90	Y-91	Nb-95	Tc-99
Ru-103	Ru-106	Rh-103m	Rh-106	Ag-110m	Cd-113m	Cd-115m
Sn-119m	Sn-123	Sn-126	Sb-124	Sb-125	Te-123m	Te-125m
Te-127	Te-127m	Te-129	Te-129m	I-129	Cs-134	Cs-135
Cs-136	Cs-137	Ba-137m	Ba-140	Ce-141	Ce-144	Pr-144
Pr-144m	Pm-146	Pm-147	Pm-148	Pm-148m	Sm-151	Eu-152
Eu-154	Eu-155	Gd-153	Tb-160	Pu-238	Pu-239	Pu-240
Pu-241	Am-241	Am-242m	Am-243	Cm-242	Cm-243	Cm-244
Corrosion products (6 nuclides)						
Mn-54	Fe-59	Co-58	Co-60	Ni-63	Zn-65	
Nuclides other than the above (2 nuclides)						
H-3	C-14					
Nuclides other than the 64 nuclides (20 nuclides)						
Cl-36	Ca-41	Ni-59	Se-79	Nb-94	Mo-99	Tc-99m
Te-132	I-131	I-132	La-140	U-233	U-234	U-235
U-236	U-238	Np-237	Pu-242	Cm-245	Cm-246	

2.2 Previous studies used in developing the analysis plan

[Excerpt from the Supplementary Explanation of the Implementation Plan for the ALPS Treated Water Dilution/Discharge Facilities and Related Facilities (July 2022)]

To develop the nuclide analysis plan, the nuclides to be analyzed were selected from the nuclides pointed out in previous studies, which are shown below, according to the following conditions.

- Nuclides that have not been analyzed in the past or have not been analyzed sufficiently
- Nuclides that were not studied at the time of selecting nuclides to be removed by ALPS
- β and γ nuclides which, according to previous studies, exist in reactor water as activation products at a concentration 1/100 or more of the concentration of Co-60 in stagnant water
- α nuclides except nuclides whose concentration can be assessed by decay chain.

Even when nuclides fall under the above conditions, if they have a half-life of less than 1 year and reduced to about 1/1000 or less due to decay over 12 years up to discharge, those nuclides were excluded. On the other hand, even when nuclides do not fall under the above conditions, if it is possible to analyze them at external analysis organizations, some of them were included in the plan.

[Previous studies]

- (1) Joint Electric Power Research Project "Study related to decommissioning of BWR nuclear reactor (Part 2)" (FY 1996)
- (2) Tokai low-level radioactive waste burial facility, Type II waste disposal business license application "selection of major radioactive nuclides" (February 2018, Japan Atomic Power Company)
- (3) Study data when JAEA examined nuclides to be analyzed to grasp 1F radioactive waste physical properties
 - The upper three orders of magnitude for the nuclides with the highest relative importance D/C among the nuclides included in either the nuclear reactor waste or the cycle waste targeting trench disposal, pit disposal, and surplus depth disposal in "about the upper limit of activity concentration for burial disposal of low-level radioactive waste"
 - Those selected as important nuclides in the "TRU waste disposal technology review report - second TRU waste disposal research and development report"
 - Those selected as important nuclides in "technical reliability of geological disposal of high-level radioactive waste in Japan - second summary of research and development on geological disposal - general report"
 - "Application for burying business license for Japan Nuclear Fuel Rokkasho low level radioactive waste storage center (near surface pit disposal) and JPDR (near surface trench disposal)"

2.3 Nuclides to be analyzed that have been identified based on previous studies (β and γ nuclides, etc.)

[Excerpt from the Supplementary Explanation of the Implementation Plan for the ALPS Treated Water Dilution/Discharge Facilities and Related Facilities (July 2022) (The measuring method revised)]

Based on the previous studies in paragraph 2.2, β , γ and other nuclides to be analyzed were identified as shown in Table 1.1.2-2.

Since it is currently difficult for TEPCO to measure the identified nuclides on their own, the measurement is planned to be commissioned to an external organization.

Table 1.1.2-2 shows that the identified nuclides' energy is generally lower than that of the nuclides that are representative at Fukushima Daiichi NPS: Cs-137 (Ba-137 m), 0.662 MeV (γ -rays); Sr-90 (Y-90), 2.28 MeV (β -rays).

Table 1.1.2-2 Nuclides to be analyzed that have been identified based on previous studies (β and γ nuclides, etc.)

Candidate nuclides	Previous studies* ¹	Disintegration form	Energy [MeV]	Regulatory concentration limit [Bq/cm ³]	Measuring method	Remarks
Cl-36	[1] [2] [3]	β -	0.709550	9.0E-01	After pretreatment (separation, precipitation), a low-background β -ray spectrometer	Has ever been analyzed by an external organization
Se-79	[1][3]	β -	0.150630	2.0E-01	After pretreatment (separation, precipitation, and resolution), liquid scintillation counter	Has ever been analyzed by an external organization
Zr-93	[1] [2] [3]	β -	0.090800	1.0E+00	After pretreatment (separation), inductively coupled plasma mass spectrometer (ICP-MS)	—
Pd-107	[3]	β -	0.034000	2.0E+01		—
Ca-41	[1] [2] [3]	EC	0.003310	4.0E+00	After pretreatment (separation, precipitation, and resolution), Si (Li) detector	Has ever been analyzed by an external organization
Fe-55	[1][2]	EC	0.005900	2.0E+00	After pretreatment (separation), low-energy photon measuring device (LEPS)	—
Ni-59	[1] [2] [3]	EC	0.006930	1.0E+01		—
Nb-93m	[2]	IT	0.016615	7.0E+00		—
Mo-93	[1] [2] [3]	EC	0.016615	3.0E-01		—
Sn-121m	[3]* ²	β -IT	0.359800 0.026359	2.0E+00		—
Ba-133	[1][2]	EC	0.356013	5.0E-01	Germanium semiconductor detector (Ge)	—

*1: Refer to the numbers in section 2.2 "Previous studies."

*2: Selected because the study shows the nuclide is generated the most among Sn isotopes from zircaloy contained in cladding tubes, etc.

2.4 Nuclides to be analyzed that have been identified based on previous studies (α nuclides)

[Excerpt from the Supplementary Explanation of the Implementation Plan for the ALPS Treated Water Dilution/ Discharge Facilities and Related Facilities (July 2022) (Remarks revised)]

Based on the previous studies in paragraph 2.2, α nuclides to be analyzed were identified as shown in Table 1.1.2-3.

Since it is currently difficult for TEPCO to measure the identified nuclides on their own, the measurement is planned to be commissioned to an external organization.

The following nuclides were analyzed to identify α nuclides that may be contained in building stagnant water at significant concentrations.

Table 1.1.2-3 Nuclides to be analyzed that have been identified based on previous studies (α nuclides)

Candidate nuclides	Previous studies*1	Disintegration form	Energy [MeV]	Regulatory concentration limit [Bq/cm ³]	Half-life [y]	Measuring method	Remarks	
U-233	[3]	α	4.824200	2.0E-02	1.6E+05	After pretreatment (separation), inductively coupled plasma mass spectrometer (ICP-MS)	Has ever been analyzed by an external organization	
U-234	[1][3]	α	4.774600	2.0E-02	2.5E+05		Has ever been analyzed by an external organization	
U-235	[1][3]	α	4.395400	2.0E-02	7.0E+08		Has ever been analyzed by an external organization	
U-236	[1][3]	α	4.494000	2.0E-02	2.3E+07		Has ever been analyzed by an external organization	
U-238	[1][3]	α	4.198000	2.0E-02	4.5E+09		Has ever been analyzed by an external organization	
Np-237	[1][3]	α	4.788000	9.0E-03	2.1E+06		Has ever been analyzed by an external organization	
Pu-238	[1] [2] [3]	α	5.499030	4.0E-03	8.8E+01	After pretreatment (separation), α -spectrometer	Pu-238 to Pu-241 are nuclides to be removed by ALPS. The concentration of Pu-241 was estimated using an isotope.	
Pu-239	[1] [2] [3]	α	5.156590	4.0E-03	2.4E+04			
Pu-240	[1] [2] [3]	α	5.168170	4.0E-03	6.6E+03			
Pu-241	[1] [2] [3]	β -	0.020780	2.0E-01	1.4E+01	—		
Pu-242	[1][3]	α	4.902300	4.0E-03	3.7E+05	After pretreatment (separation), α -spectrometer	Has ever been analyzed by an external organization	
Am-241	[1] [2] [3]	α	5.485560	5.0E-03	4.3E+02		After pretreatment (separation), α -spectrometer	Am-241 to Am-243 are nuclides to be removed by ALPS. The concentration of Am-242m was estimated using an isotope.
Am-242m	[1][3]	IT	0.018856	5.0E-03	1.4E+02			
Am-243	[1][3]	α	5.275300	5.0E-03	7.4E+03	After pretreatment (separation), α -spectrometer		Cm 242 to Cm-234 are nuclides to be removed by ALPS. Cm-243 and Cm-244, and Cm-245 and Cm-246 were measured as combined values as their energies are close to each other. Cm-245 and Cm-246 have ever been analyzed by an external organization.
Cm-242	[3]	α	6.112720	6.0E-02	4.5E-01			
Cm-243	[3]	α	5.785200	6.0E-03	2.9E+01			
Cm-244	[1][3]	α	5.804770	7.0E-03	1.8E+01			
Cm-245	[3]	α	5.361100	5.0E-03	8.4E+03			
Cm-246	[3]	α	5.386500	5.0E-03	4.7E+03			

*1: Refer to the numbers in section 2.2 "Previous studies."

1.1.2-5

2.5 Analysis result of nuclides to be analyzed

The nuclides to be analyzed which have been identified in section 2.3 through 2.4 were checked to see if they exist in building stagnant water, strontium removed water and ALPS treated water at significant concentrations.

As a result, some of them were detected in building stagnant water and water before treatment by ALPS, but nuclides (including α nuclides) pointed out in previous studies were 1/100 or less of the regulatory concentration limit and below the lower detection limit* in ALPS treated water.

*: For uranium, natural uranium in the environment was detected.

(1) ALPS treated water, etc. analysis results (β and γ nuclides, etc.)

Table 1.1.2-4 shows the analysis results of β and γ nuclides in ALPS treated water, etc.

Since the presence of suspended matters was visually confirmed in the building stagnant water and strontium removed water before the treatment by ALPS, they were filtered with a 0.45 μm filter, and the filtrate and the residual were analyzed separately (for elements that are likely to be precipitated). Therefore, some analytical results are reported separately for the filtrate and the residue. In this case, considering the conservativity of the analytical results of the entire sample, the sum of the results of the filtrate and the residue shall be used as the analytical value of the entire sample when both or either of them are detected, and the higher value of the detection limit shall be used as the analytical value of the entire sample when neither is detected. Some of the ALPS treated water was also filtered and γ -rays of the used filter was measured. As a result, Cs-134, Cs-137, Co-60, which were found in filters for water up to ALPS treatment, were not detected. That shows that most of insoluble radionuclides have been removed through the ALPS treatment and that the filtering has no impacts. The analysis result of β and γ nuclides in each sample has confirmed that most nuclides were below the detection limit, but Fe-55, Ni-59, Se-79 and Pd-107 were detected in the building stagnant water at concentrations about 1/100, 1/1000, 1/20 and 1/80000 of the regulatory concentration limits respectively. And Ni-59, Se-79 and Pd-107 were detected before ALPS treatment at a concentration of about 1/5000, 1/20, 1/80000 of the regulatory concentration limit and Pd-107 at about 1/80000 of the regulatory concentration limits respectively. On the other hand, in water after ALPS treatment, each nuclide was 1/100 or less of the regulatory limit and below the detection limit.

Table 1.1.2-4 Results of nuclide analysis targeting nuclides to be analyzed (β and γ nuclides, etc.) (1/3)

Nuclide	Regulatory concentration limit [Bq/L]	Type of specimen	Sampling location	Date of collection	Sampling method* ¹	Base date	Analytical value [Bq/L]	External analytical organization	Measuring instrument		
Fe-55	2.00E+03	-	K4-A10 tank	Nov. 1, 2021	(1)	Mar. 7, 2022	< 2.7E+00	NFD* ²	Low-energy photon measuring device		
		-	H4-B7 tank	Nov. 1, 2021		Apr. 14, 2022	< 2.3E+00				
		-	After treatment by additional ALPS	Oct. 28, 2021		May. 17, 2022	< 3.0E+00				
		Filtrate	Before treatment by additional ALPS	Oct. 28, 2021		Jun. 23, 2022	< 1.5E+01				
		Residue			Sep. 15, 2022	< 4.3E+00					
		Filtrate	Process Main Building	Nov. 2, 2021	(2)-a	Jul. 22, 2022	< 4.1E+00				
		Residue				Sep. 5, 2022	1.7E+01 \pm 0.1E+01				
Ni-59	1.00E+04	-	K4-A10 tank	Nov. 1, 2021	(1)	Mar. 9, 2022	< 2.3E+00			NFD* ²	Low-energy photon measuring device
		-	H4-B7 tank	Nov. 1, 2021		Apr. 19, 2022	< 6.6E+00				
		-	After treatment by additional ALPS	Oct. 28, 2021		May 23, 2022	< 2.3E+00				
		Filtrate	Before treatment by additional ALPS	Oct. 28, 2021		Jun. 27, 2022	2.2E+00 \pm 0.3E+00				
		Residue			Sep. 26, 2022	< 1.0E+00					
		Filtrate	Process Main Building	Nov. 2, 2021	(2)-a	Jul. 26, 2022	9.4E+00 \pm 0.7E+00				
		Residue				Sep. 8, 2022	3.5E+00 \pm 0.5E+00				
Nb-93m	7.00E+03	-	K4-A10 tank	Nov. 1, 2021	(1)	Mar. 8, 2022	< 8.6E+00	NFD* ²	Low-energy photon measuring device		
		-	H4-B7 tank	Nov. 1, 2021		May 10, 2022	< 1.5E+01				
		-	After treatment by additional ALPS	Oct. 28, 2021		May 18, 2022	< 7.8E+00				
		Filtrate	Before treatment by additional ALPS	Oct. 28, 2021		Jun. 13, 2022	< 5.6E+01				
		Residue			Sep. 20, 2022	< 5.2E+00					
		Filtrate	Process Main Building	Nov. 2, 2021	(2)-a	Jul. 21, 2022	< 5.2E+01				
		Residue				Sep. 6, 2022	< 4.4E+00				

*1: Details are shown in Figure 1.1.2-2.

*2: Nippon Nuclear Fuel Development Co., Ltd.

1.1.2-7

Table 1.1.2-4 Results of nuclide analysis targeting nuclides to be analyzed (β and γ nuclides, etc.) (2/3)

Nuclide	Regulatory concentration limit [Bq/L]	Type of specimen*1	Sampling location	Date of collection	Sampling method*1	Base date	Analytical value [Bq/L]	External analytical organization	Measuring instrument
Mo-93	3.00E+02	-	K4-A10 tank	Nov. 1, 2021	(1)	Mar. 10, 2022	< 1.1E+00	NFD*2	Low-energy photon measuring device
		-	H4-B7 tank	Nov. 1, 2021		Apr. 18, 2022	< 2.0E+00		
		-	After treatment by additional ALPS	Oct. 28, 2021		May 19, 2022	< 1.0E+00		
		Filtrate	Before treatment by additional ALPS	Oct. 28, 2021		Jun. 14, 2022	< 1.7E+00		
		Residue			Sep. 21, 2022	< 6.4E-01			
		Filtrate	Process Main Building	Nov. 2, 2021	(2)-a	Jul. 25, 2022	< 1.2E+00		
		Residue				Sep. 7, 2022	< 1.4E+00		
Sn-121m	2.00E+03	-	K4-A10 tank	Nov. 1, 2021	(1)	Mar. 22, 2022	< 1.7E+00	NFD*2	Low-energy photon measuring device
		-	H4-B7 tank	Nov. 1, 2021		Apr. 8, 2022	< 5.3E+00		
		-	After treatment by additional ALPS	Oct. 28, 2021		May 20, 2022	< 2.0E+00		
		Filtrate	Before treatment by additional ALPS	Oct. 28, 2021		Jun. 16, 2022	< 1.2E+01		
		Residue			Sep. 22, 2022	< 2.9E+00			
		Filtrate	Process Main Building	Nov. 2, 2021	(2)-a	Jul. 28, 2022	< 9.2E+00		
		Residue				Sep. 2, 2022	< 1.1E+00		
Cl-36	9.00E+02	Filtrate	K4-A10 tank	Jan. 26, 2022	(1)	May 13, 2022	< 4.2E+00	NDC*3	Low-background β -ray spectrometer
		Filtrate	H4-B7 tank	Jan. 26, 2022		May 30, 2022	< 5.5E+00		
		Filtrate	After treatment by additional ALPS	Feb. 10, 2022		May 13, 2022	< 3.9E+00		
		Filtrate	Before treatment by additional ALPS	Feb. 10, 2022		May 17, 2022	< 3.7E+00		
		Filtrate	Process Main Building	Feb. 4, 2022	(2)-a	May 23, 2022	< 4.3E+00		

*1: Details are shown in Figure 1.1.2-2.

*2: Nippon Nuclear Fuel Development Co., Ltd.

*3: MHI Nuclear Development Corporation

1.1.2-8

Table 1.1.2-4 Results of nuclide analysis targeting nuclides to be analyzed (β and γ nuclides, etc.) (3/3)

Nuclide	Regulatory concentration limit [Bq/L]	Type of specimen	Sampling location	Date of collection	Sampling method*1	Base date	Analytical value [Bq/L]	External analytical organization	Measuring instrument
Ca-41	4.00E+03	Filtrate	K4-A10 tank	Jan. 26, 2022	(1)	Jun. 3, 2022	< 7.9E+00	NDC*7	Si (Li) semiconductor detector
		Filtrate	H4-B7 tank	Jan. 26, 2022		Jun. 6, 2022	< 7.9E+00		
		Filtrate	After treatment by additional ALPS	Feb. 10, 2022		Jun. 1, 2022	< 7.4E+00		
		Filtrate	Before treatment by additional ALPS	Feb. 10, 2022		Jun. 14, 2022	< 1.9E+01		
		Filtrate	Process Main Building	Feb. 4, 2022	(2)-a	Jun. 13, 2022	< 1.4E+01		
Zr-93	1.00E+03	Filtrate	K4-A10 tank	Jan. 26, 2022	(1)	May 24, 2022	< 8.4E-01	NDC*7	Inductively coupled plasma mass spectrometer
		Filtrate	H4-B7 tank	Jan. 26, 2022		May 24, 2022	< 8.4E-01		
		Filtrate	After treatment by additional ALPS	Feb. 10, 2022		May 24, 2022	< 8.4E-01		
		Filtrate	Before treatment by additional ALPS	Feb. 10, 2022		May 24, 2022	< 8.4E-01		
		Residue	Process Main Building	Feb. 4, 2022	(2)-a	Jun. 7, 2022	< 1.3E+00		
		Filtrate				May 24, 2022	< 8.4E-01		
		Residue				Jun. 7, 2022	< 1.3E+00		
Ba-133	5.00E+02	Filtrate	K4-A10 tank	Jan. 26, 2022	(1)	Apr. 23, 2022	< 7.3E-01	NDC*7	Ge semiconductor detector
		Filtrate	H4-B7 tank	Jan. 26, 2022		Apr. 22, 2022	< 7.0E-01		
		Filtrate	After treatment by additional ALPS	Feb. 10, 2022		Apr. 24, 2022	< 7.0E-01		
		Filtrate	Before treatment by additional ALPS	Feb. 10, 2022		Apr. 21, 2022	< 4.3E+00		
		Filtrate	Process Main Building	Feb. 4, 2022	(2)-a	Jun. 2, 2022	< 2.6E+00		
Se-79	2.00E+02	Filtrate	After treatment by additional ALPS	Apr. 22, 2022	(1)	*2	< 1.5E+00	JAEA	Liquid scintillation counter
		Filtrate	Before treatment by additional ALPS	Apr. 22, 2022		*3	9.0E+00*6		
		Filtrate	Process Main Building	Apr. 21, 2022	(2)-b	*4	9.7E+00*5,6		
Pd-107	2.00E+04	Filtrate	After treatment by additional ALPS	Apr. 22, 2022	(1)	Oct. 6, 2022	< 7.1E-02	JAEA	Inductively coupled plasma mass spectrometer
		Filtrate	Before treatment by additional ALPS	Apr. 22, 2022		Oct. 6, 2022	2.4E-01*6		
		Filtrate	Process Main Building	Apr. 21, 2022	(2)-b	Oct. 6, 2022	7.8E-02*5,6		

*1: Details are shown in Figure 1.1.2-2. *2: Sep.27, 2022; Sep. 27, 2022; Oct. 14, 2022 *3: Oct. 2, 2022; Oct. 2, 2022; Oct. 14, 2022 *4: Sep. 21, 2022; Oct. 8, 2022 ; Oct. 8, 2022

*5: The same specimen was analyzed three times, and the value detected once was recorded. (In water before/after ALPS treatment, all of the three results were detected/below the detection limit, so the mean value was recorded)

*6 Uncertainty assessment of measurement is not performed *7 MHI Nuclear Development Corporation

1.1.2-9

(2) ALPS treated water, etc. analysis results (α nuclides)

Table 1.1.2-5 shows the analysis results of α nuclides in ALPS treated water, etc.

In order to identify α nuclides that are contained in the building stagnant water at significant concentrations, the measurement of them were tried up to 1/100 or less of the regulatory concentration limits. In ALPS treated water, most nuclides were 1/100 or less of the regulatory concentration limits and below the detection limits, but trace amounts of U-235 and U-238 were detected. However, considering that the mass ratio*¹ changed in the order of 1.8% (the ratio equivalent to spent fuel), 1.2% to 0.7% (the ratio of natural composition) in the process of treatment and based on other reasons*², they are considered to be natural uranium contained in ALPS treated water.

In this analysis too, suspended matter was visually confirmed in the building stagnant water and strontium removed water before ALPS treatment. So, they were filtered with a 0.45 μm filter, and then the filtrate and the residue were analyzed separately (for elements that are likely to be precipitated). Therefore, some analytical results are reported separately for the filtrate and the residue. In this case, considering the conservativity of the analytical results of the entire sample, the sum of the results of the filtrate and the residue shall be used as the analytical value of the entire sample when both or either of them are detected, and the higher value of the detection limit shall be used as the analytical value of the entire sample when neither is detected. As is the case with β , γ and other nuclides, some of the ALPS treated water was also filtered, and γ -rays of the used filter was measured. As a result, Cs-134, Cs-137, Co-60, which were found in filters for water up to ALPS treatment, were not detected. That shows that most of insoluble radionuclides have been removed through the ALPS treatment and that the filtering has no impacts.

*1: Calculated from $X = \lambda w/A \times N_A$ (X : radioactivity, λ : decay constant, w : mass, A : number of atoms, N_A : Avogadro constant)

*2: Within the range of uranium concentrations in Japanese rivers (excluding Okinawa), 0.47 to 488 ng/L

[Natural level uranium concentration in Japanese rivers (Mochizuki et al.)]

(approx. 6E-06 to 6E-03 Bq/L: U-238 equivalent), or U-236 derived from fuel was not detected.

Table 1.1.2-5 Results of nuclide analysis targeting nuclides to be analyzed (α nuclides) (1/5)

Nuclide	Regulatory concentration limit [Bq/L]	Type of sample	Sampling location	Date of collection	Sampling method* ¹	Base date	Analytical value [Bq/L]	External analytical organization	Measuring instrument		
U-233	2.00E+01	-	K4-A10 tank	Nov. 1, 2021	(1)	Jul. 14, 2022	< 1.4E-02	NFD* ²	Inductively coupled plasma mass spectrometer		
		-	H4-B7 tank	Nov. 1, 2021		Jul. 14, 2022	< 1.3E-02				
		-	After treatment by additional ALPS	Oct. 28, 2021		Jul. 14, 2022	< 1.3E-02				
		Filtrate	Before treatment by additional ALPS	Oct. 28, 2021		Jul. 14, 2022	< 1.3E-02				
		Residue			Sep. 27, 2022	< 2.4E-03					
		Filtrate	Process Main Building	Nov. 2, 2021	(2)-a	Jul. 14, 2022	< 1.3E-02				
		Residue				Sep. 27, 2022	< 1.4E-03				
U-234	2.00E+01	-	K4-A10 tank	Nov. 1, 2021	(1)	Jul. 14, 2022	< 8.7E-03			NFD* ²	Inductively coupled plasma mass spectrometer
		-	H4-B7 tank	Nov. 1, 2021		Jul. 14, 2022	< 8.7E-03				
		-	After treatment by additional ALPS	Oct. 28, 2021		Jul. 14, 2022	< 8.7E-03				
		Filtrate	Before treatment by additional ALPS	Oct. 28, 2021		Jul. 14, 2022	< 8.7E-03				
		Residue			Sep. 27, 2022	< 1.6E-03					
		Filtrate	Process Main Building	Nov. 2, 2021	(2)-a	Jul. 14, 2022	1.3E-01 ± 1.7E-02				
		Residue				Sep. 26, 2022	2.8E-02 ± 4.3E-03				
U-235	2.00E+01	-	K4-A10 tank	Nov. 1, 2021	(1)	Jul. 14, 2022	5.0E-05 ± 6.0E-06	NFD* ²	Inductively coupled plasma mass spectrometer		
		-	H4-B7 tank	Nov. 1, 2021		Jul. 14, 2022	9.9E-06 ± 8.0E-07				
		-	After treatment by additional ALPS	Oct. 28, 2021		Jul. 14, 2022	8.8E-06 ± 7.8E-07				
		Filtrate	Before treatment by additional ALPS	Oct. 28, 2021		Jul. 14, 2022	2.0E-05 ± 6.0E-06				
		Residue			Sep. 27, 2022	3.9E-06 ± 3.3E-07					
		Filtrate	Process Main Building	Nov. 2, 2021	(2)-a	Jul. 14, 2022	3.7E-03 ± 9.0E-05				
		Residue				Sep. 26, 2022	6.0E-04 ± 7.0E-06				

*1: Details are shown in Figure 1.1.2-2.

*2: Nippon Nuclear Fuel Development Co., Ltd.

Table 1.1.2-5 Results of nuclide analysis targeting nuclides to be analyzed (α nuclides) (2/5)

Nuclide	Regulatory concentration limit [Bq/L]	Type of sample	Sampling location	Date of collection	Sampling method* ¹	Base date	Analytical value [Bq/L]	External analytical organization	Measuring instrument		
U-236	2.00E+01	-	K4-A10 tank	Nov. 1, 2021	(1)	Jul. 14, 2022	< 9.1E-05	NFD* ²	Inductively coupled plasma mass spectrometer		
		-	H4-B7 tank	Nov. 1, 2021		Jul. 14, 2022	< 9.1E-05				
		-	After treatment by additional ALPS	Oct. 28, 2021		Jul. 14, 2022	< 9.0E-05				
		Filtrate	Before treatment by additional ALPS	Oct. 28, 2021		Jul. 14, 2022	1.2E-04±2.4E-05				
		Residue		Sep. 27, 2022	< 1.6E-05						
		Filtrate	Process Main Building	Nov. 2, 2021	(2)-a	Jul. 14, 2022	2.2E-02±3.8E-04				
		Residue				Sep. 26, 2022	3.8E-03±1.3E-04				
U-238	2.00E+01	-	K4-A10 tank	Nov. 1, 2021	(1)	Jul. 14, 2022	1.2E-03±2.0E-05			NFD* ²	Inductively coupled plasma mass spectrometer
		-	H4-B7 tank	Nov. 1, 2021		Jul. 14, 2022	2.3E-04±1.8E-05				
		-	After treatment by additional ALPS	Oct. 28, 2021		Jul. 14, 2022	2.1E-04±1.8E-05				
		Filtrate	Before treatment by additional ALPS	Oct. 28, 2021		Jul. 14, 2022	2.3E-04±1.8E-05				
		Residue		Sep. 26, 2022	7.5E-05±2.7E-06						
		Filtrate	Process Main Building	Nov. 2, 2021	(2)-a	Jul. 14, 2022	3.1E-02±2.3E-04				
		Residue				Sep. 26, 2022	5.5E-03±6.5E-05				
Np-237	9.00E+00	-	K4-A10 tank	Nov. 1, 2021	(1)	Jul. 15, 2022	< 1.5E-03	NFD* ²	Inductively coupled plasma mass spectrometer		
		-	H4-B7 tank	Nov. 1, 2021		Jul. 15, 2022	< 1.5E-03				
		-	After treatment by additional ALPS	Oct. 28, 2021		Jul. 15, 2022	< 1.5E-03				
		Filtrate	Before treatment by additional ALPS	Oct. 28, 2021		Jul. 15, 2022	1.2E-02±4.3E-04				
		Residue		Sep. 26, 2022	8.0E-04±1.6E-04						
		Filtrate	Process Main Building	Nov. 2, 2021	(2)-a	Jul. 15, 2022	2.1E-01±2.2E-03				
		Residue				Sep. 27, 2022	8.5E-03±2.0E-04				

*1: Details are shown in Figure 1.1.2-2.

*2: Nippon Nuclear Fuel Development Co., Ltd.

1.1.2-12

Table 1.1.2-5 Results of nuclide analysis targeting nuclides to be analyzed (α nuclides) (3/5)

Nuclide	Regulatory concentration limit [Bq/L]	Type of sample	Sampling location	Date of collection	Sampling method* ¹	Base date	Analytical value [Bq/L]	External analytical organization	Measuring instrument		
Pu-238	4.00E+00	Filtrate	K4-A10 tank	Nov. 1, 2021	(1)	May 27, 2022	< 1.9E-03	NDC* ²	Surface barrier silicon semiconductor detector		
		Filtrate	H4-B7 tank	Nov. 1, 2021		May 30, 2022	< 1.9E-03				
		Filtrate	After treatment by additional ALPS	Oct. 28, 2021		May 27, 2022	< 2.5E-03				
		Filtrate	Before treatment by additional ALPS	Oct. 28, 2021		May 31, 2022	2.8E-01 \pm 8.7E-03				
		Residue	Process Main Building	Nov. 2, 2021	(2)-a	Jun. 30, 2022	4.1E-01 \pm 1.2E-02				
		Filtrate				Jun. 13, 2022	1.2E+00 \pm 2.4E-02				
Pu-239+ Pu240	8.00E+00	Filtrate	K4-A10 tank	Nov. 1, 2021	(1)	May 27, 2022	< 1.9E-03			NDC* ²	Surface barrier silicon semiconductor detector
		Filtrate	H4-B7 tank	Nov. 1, 2021		May 30, 2022	< 1.9E-03				
		Filtrate	After treatment by additional ALPS	Oct. 28, 2021		May 27, 2022	< 1.9E-03				
		Filtrate	Before treatment by additional ALPS	Oct. 28, 2021		May 31, 2022	9.1E-02 \pm 4.6E-03				
		Residue	Process Main Building	Nov. 2, 2021	(2)-a	Jun. 30, 2022	1.4E-01 \pm 6.0E-03				
		Filtrate				Jun. 13, 2022	3.9E-01 \pm 1.1E-02				
Pu-242	4.00E+00	Filtrate	K4-A10 tank	Nov. 1, 2021	(1)	May 27, 2022	< 1.9E-03	NDC* ²	Surface barrier silicon semiconductor detector		
		Filtrate	H4-B7 tank	Nov. 1, 2021		May 30, 2022	< 2.2E-03				
		Filtrate	After treatment by additional ALPS	Oct. 28, 2021		May 27, 2022	< 1.9E-03				
		Filtrate	Before treatment by additional ALPS	Oct. 28, 2021		May 31, 2022	< 4.4E-03				
		Residue	Process Main Building	Nov. 2, 2021	(2)-a	Jun. 30, 2022	< 6.1E-03				
		Filtrate				Jun. 13, 2022	< 7.9E-03				
Residue	Jul. 4, 2022	< 1.3E-02									

*1: Details are shown in Figure 1.1.2-2.

*2: MHI Nuclear Development Corporation

Table 1.1.2-5 Results of nuclide analysis targeting nuclides to be analyzed (α nuclides) (4/5)

Nuclide	Regulatory concentration limit [Bq/L]	Type of sample	Sampling location	Date of collection	Sampling method*1	Base date	Analytical value [Bq/L]	External analytical organization	Measuring instrument		
Am-241	5.00E+00	Filtrate	K4-A10 tank	Nov. 1, 2021	(1)	May 27, 2022	< 1.8E-03	NDC*2	Surface barrier silicon semiconductor detector		
		Filtrate	H4-B7 tank	Nov. 1, 2021		May 30, 2022	< 1.8E-03				
		Filtrate	After treatment by additional ALPS	Oct. 28, 2021		May 27, 2022	< 1.8E-03				
		Filtrate	Before treatment by additional ALPS	Oct. 28, 2021	Jun. 22, 2022	6.8E-02±3.6E-03					
		Residue			Jun. 30, 2022	1.2E-01±5.2E-03					
		Filtrate	Process Main Building	Nov. 2, 2021	(2)-a	Jun. 28, 2022	4.0E-02±2.8E-03				
Residue	Jul. 4, 2022	5.7E-01±1.4E-02									
Am-243	5.00E+00	Filtrate	K4-A10 tank	Nov. 1, 2021	(1)	May 27, 2022	< 1.5E-03			NDC*2	Surface barrier silicon semiconductor detector
		Filtrate	H4-B7 tank	Nov. 1, 2021		May 30, 2022	< 1.5E-03				
		Filtrate	After treatment by additional ALPS	Oct. 28, 2021		May 27, 2022	< 1.5E-03				
		Filtrate	Before treatment by additional ALPS	Oct. 28, 2021	Jun. 22, 2022	< 7.7E-03					
		Residue			Jun. 30, 2022	< 5.5E-03					
		Filtrate	Process Main Building	Nov. 2, 2021	(2)-a	Jun. 28, 2022	< 5.1E-03				
Residue	Jul. 4, 2022	< 1.7E-02									
Cm-242	6.00E+01	Filtrate	K4-A10 tank	Nov. 1, 2021	(1)	May 27, 2022	< 1.5E-03	NDC*2	Surface barrier silicon semiconductor detector		
		Filtrate	H4-B7 tank	Nov. 1, 2021		May 30, 2022	< 1.5E-03				
		Filtrate	After treatment by additional ALPS	Oct. 28, 2021		May 27, 2022	< 1.6E-03				
		Filtrate	Before treatment by additional ALPS	Oct. 28, 2021	Jun. 22, 2022	< 1.6E-03					
		Residue			Jun. 30, 2022	5.5E-03±1.0E-03					
		Filtrate	Process Main Building	Nov. 2, 2021	(2)-a	Jun. 28, 2022	< 1.5E-03				
Residue	Jul. 4, 2022	9.9E-03±1.4E-03									

*1: Details are shown in Figure 1.1.2-2.

*2: MHI Nuclear Development Corporation

1.1.2-14

Table 1.1.2-5 Results of nuclide analysis targeting nuclides to be analyzed (α nuclides) (5/5)

Nuclide	Regulatory concentration limit [Bq/L]	Type of sample	Sampling location	Date of collection	Sampling method*1	Base date	Analytical value [Bq/L]	External analytical organization	Measuring instrument
Cm-243 +Cm-244	1.30E+01	Filtrate	K4-A10 tank	Nov. 1, 2021	(1)	May 27, 2022	< 1.5E-03	NDC*2	Surface barrier silicon semiconductor detector
		Filtrate	H4-B7 tank	Nov. 1, 2021		May 30, 2022	< 1.5E-03		
		Filtrate	After treatment by additional ALPS	Oct. 28, 2021		May 27, 2022	< 1.8E-03		
		Filtrate	Before treatment by additional ALPS	Oct. 28, 2021		Jun. 22, 2022	6.4E-02±3.4E-03		
		Residue				Jun. 30, 2022	9.1E-02±4.4E-03		
		Filtrate	Process Main Building	Nov. 2, 2021		(2)-a	Jun. 28, 2022		
Residue	Jul. 4, 2022	4.4E-01±1.1E-02							
Cm-244 +Cm-245	1.00E+01	Filtrate	K4-A10 tank	Nov. 1, 2021	(1)	May 27, 2022	< 1.5E-03	NDC*2	Surface barrier silicon semiconductor detector
		Filtrate	H4-B7 tank	Nov. 1, 2021		May 30, 2022	< 4.7E-03		
		Filtrate	After treatment by additional ALPS	Oct. 28, 2021		May 27, 2022	< 1.5E-03		
		Filtrate	Before treatment by additional ALPS	Oct. 28, 2021		Jun. 22, 2022	< 2.1E-02		
		Residue				Jun. 30, 2022	< 2.6E-02		
		Filtrate	Process Main Building	Nov. 2, 2021		(2)-a	Jun. 28, 2022		
Residue	Jul. 4, 2022	< 6.0E-02							

*1: Details are shown in Figure 1.1.2-2.

*2: MHI Nuclear Development Corporation

1.1.2-15

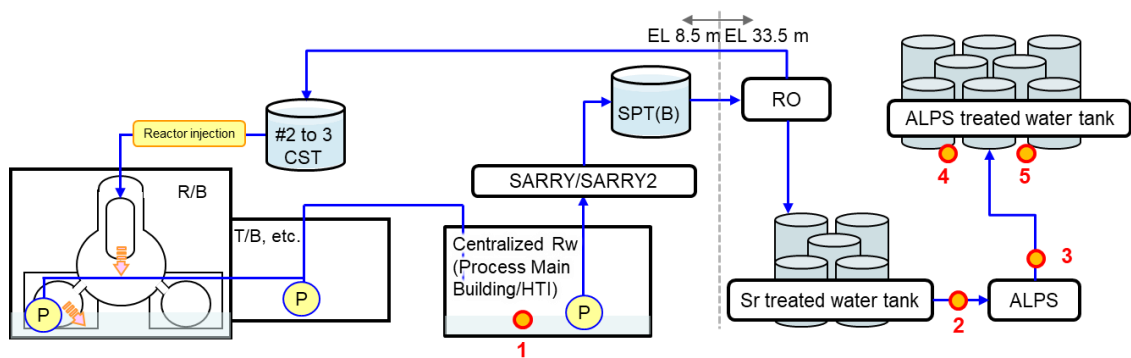

No.	Sampling location	Sampling method
1	Process Main Building	See (2).
2	Before treatment by ALPS	Collect from sampling rack installed at the inlet of ALPS
3	After treatment by ALPS	Collect from sampling rack installed at the outlet of ALPS
4	H4-B7 tank	Collected from the upper part of the tank using a water sampler.
5	K4-A10 tank	

(1) Sampling locations and methods for the nuclide analysis this time

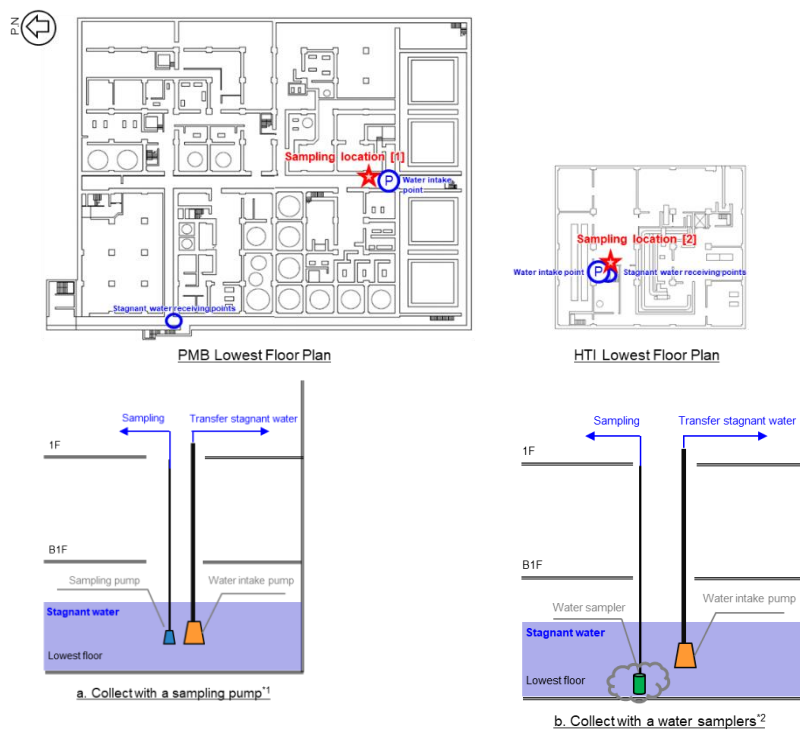

*1: The suction point of the sampling pump is set at the same height as that of the sampling pump.

*2: Since sediment on the bottom of the building was stirred up during sampling, samples collected contained more sludge than usual.

(2) Method for collecting samples from the Process Main Building

Figure 1.1.2-2 Sampling locations and methods for the nuclide analysis targeting nuclides to be analyzed

This time, for the samples for which additional analysis was performed, samples were taken from the same places as routine sampling points for checking the performance of normal stagnant water and water treatment facilities. However, as shown in Figure 1.1.2-2 (2), two types of sampling were performed for the process main building. In routine sampling during normal operation, water is sampled with a sampling pump as in (a). As a result, shown in Figure 1.1.2-3, it was confirmed that the analytical results of Cs-137 and Sr-90 showed the same concentration as the water at the inlet of the cesium adsorption equipment after the intake pump. On the other hand, in the sampling carried out in (b), the stagnant water in buildings containing sludge settled at the bottom of the building was sampled, and considering the performance of ALPS capable of removing up to 20 nm with a cross-flow filter, the plan is to remove it with a 0.45 μm filter and analyze the nuclides dissolved in water that require treatment with ALPS, etc.

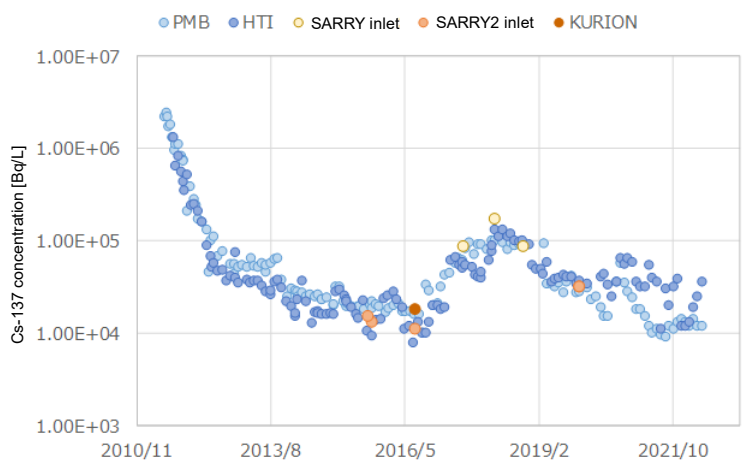

a. Analytical results of Cs-137

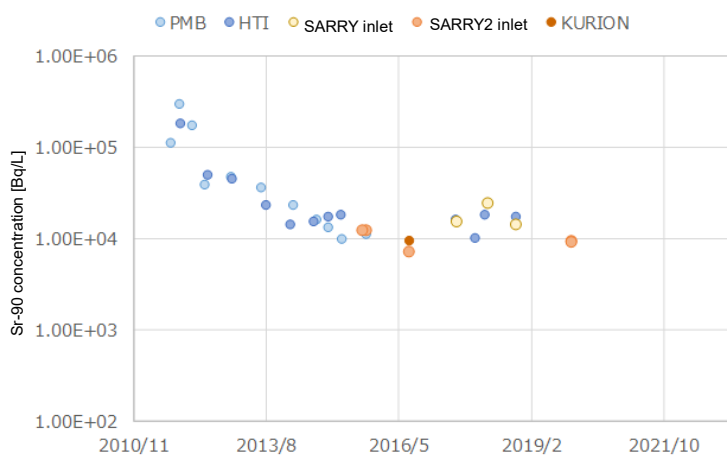

b. Analytical results of Sr-90

Figure 1.1.2-3 Comparison of analysis results between process main building and cesium adsorption equipment inlet

(Reference) Supplemental remarks on the analysis method for the additional analysis

In the analysis this time, suspended matter was visually confirmed in the stagnant water from the Process Main Building and in the strontium removed water before the ALPS treatment. Therefore, they were filtered with a 0.45 μm filter before analysis. (See Figure 1.1.2-4.)

This analysis method has been adopted for light water reactors as a method to separate soluble from insoluble nuclides. It was used in this analysis to separate and identify which nuclides are insoluble and can be easily removed and which nuclides are dissolved in water and need to be removed by ALPS, etc.

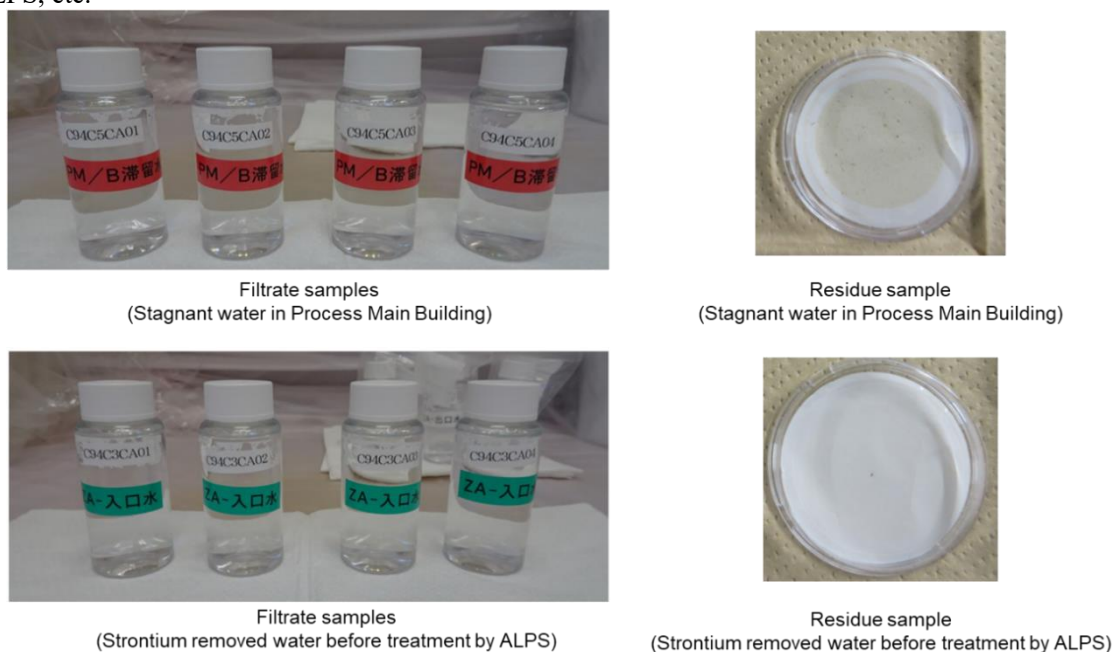

Figure 1.1.2-4 Filtrate samples and residue samples from samples to be analyzed (stagnant water in Process Main Building and strontium removed water before ALPS treatment)

2.6 Summary of the nuclide analysis

This time, in examining the nuclides to be measured and assessed at the discharge of ALPS treated water into the sea, among nuclides that have been the focus of studies about decommissioning and burial facilities, etc., excluding those with short half-lives, nuclides that have never been analyzed or have not been analyzed sufficiently so far were analyzed. As a result, they were not detected in the ALPS treated water, being 1/100 or less of the regulatory concentration limits.

The analysis have revealed that the nuclides that may exist in the ALPS treated water at significant concentrations are the major seven nuclides, carbon 14 and technetium 99.

With regard to the nuclides to be measured and assessed when discharging ALPS treated water into the sea, in addition to the above 9 nuclides, the selection is based on a process of confirming that nuclides that exist/may exist at significant concentrations in stagnant water in buildings and strontium removed water before treatment by ALPS have been removed from ALPS treated water to be discharged into the sea to the point that the discharge standards are satisfied.

Supplementary explanation on the inventory assessment in the examination of nuclides to be measured and assessed at the discharge of ALPS treated water into the sea

1. Overview

In order to ensure that the sum of the ratios to regulatory concentration limits of radionuclides other than tritium in ALPS treated water is less than 1, thorough verifications will be performed, while taking into account previous studies on decommissioning and disposal facilities in Japan, to check for significant presence of nuclides in the contaminated water. Then radionuclides to be measured and assessed (hereinafter referred to as nuclides to be measured and assessed) will be selected. The examination will be carried out in accordance with the flow explained at the 9th Review Meeting on the Implementation Plan Regarding the Handling of ALPS Treated Water (See Figure 1.1.3-1), and a nuclide analysis and inventory assessment are planned to be performed. This document supplements the explanation about the inventory assessment.

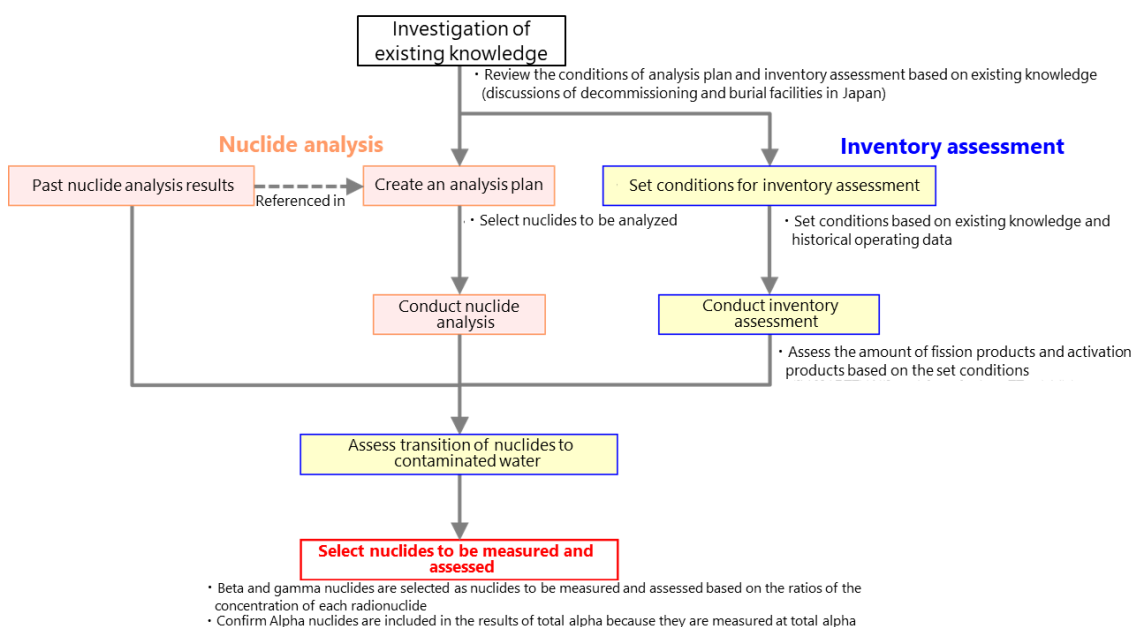

Figure 1.1.3-1 Overall procedure for examining the selection of the nuclides to be measured and assessed
[Excerpt from a document for the 9th Review Meeting on the Implementation Plan Regarding the Handling of ALPS Treated Water (partially revised)]

2. Inventory assessment

*[Excerpt from the Supplementary Explanation of the Implementation Plan for the ALPS Treated Water Dilution/
Discharge Facilities and Related Facilities (July 2022)]*

As the inventory assessment, fission products and radioactive materials such as actinoids generated from nuclear fuel materials (hereinafter referred to as "fission products") have been assessed in nuclear power plant safety assessments (used to examine nuclides to be removed by ALPS), while in studies regarding decommissioning and disposal facilities, activation of equipment in nuclear power plants has been calculated. In this examination, assessment of fission products and activation products will be performed while referring to the above assessments.

In both assessments, reduction in the inventory due to decay will also be assessed while taking into account that 12 years will have passed at the time of the discharge since the earthquake.

ORNL Isotope Generation and Depletion Code (ORIGEN: code system for calculating the generation, disintegration, and depletion of radioactive materials) will be used for the assessment as was the case with safety assessments, previous studies and other assessments so far.

Based on the result of ORIGEN assessment, the easiness of transfer into water will be taken into account, and then nuclides that may be contained at significant concentrations in building stagnant water will be identified.

2.1 Assessment of fission products

*[Excerpt from the Supplementary Explanation of the Implementation Plan for the ALPS Treated Water Dilution/
Discharge Facilities and Related Facilities (July 2022)]*

In the assessment of fission products, safety assessments at normal nuclear power plants will be referred to as they were in the examination of nuclides to be removed by ALPS, and the inventory as of March, 2011 will be assessed based on the condition of the fuel loaded in the Units 1 to 3 reactor pressure vessels at Fukushima Daiichi NPS as well as on the condition of the burnup assumed from the loading period of each piece of fuel. After March of 2011, the decrease in the inventory due to decay over 12 years will be calculated.

ORIGEN can assess inventories which are generated from nuclear fuel, disintegrated, and depleted. Regarding nuclear fission, it can assess that uranium 235 produces two nuclides mainly at peaks around mass numbers 95 and 140 in the process of fission. In addition, it is also capable of assess the generation of nuclides produced when uranium 238 absorbs neutrons, such as plutonium, as well as nuclides produced when fission products absorb neutrons, such as cesium 134.

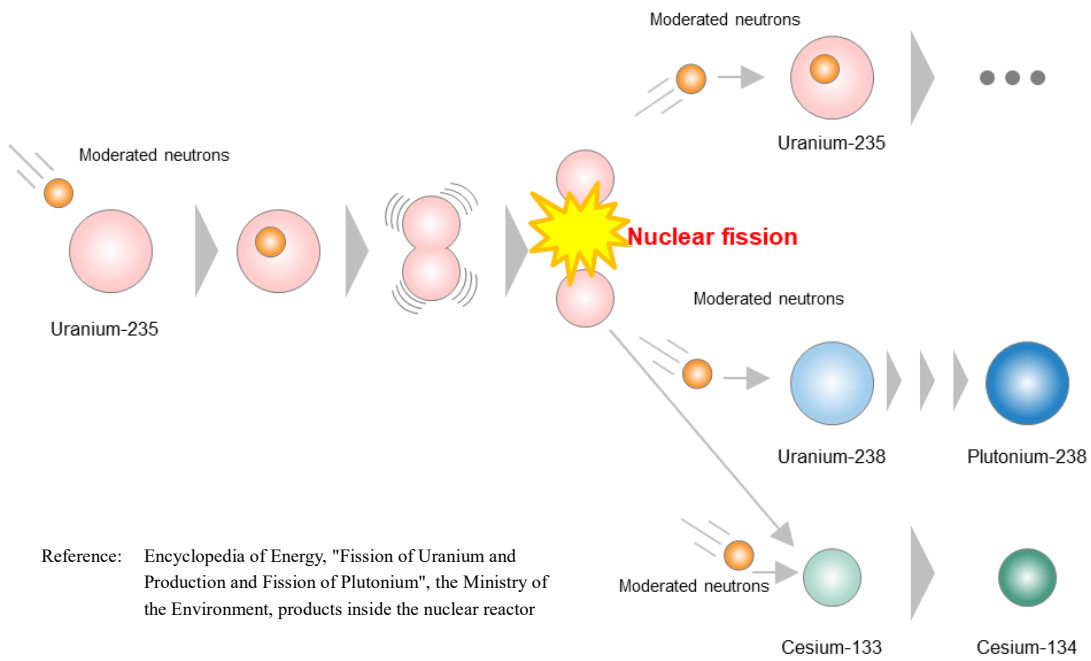
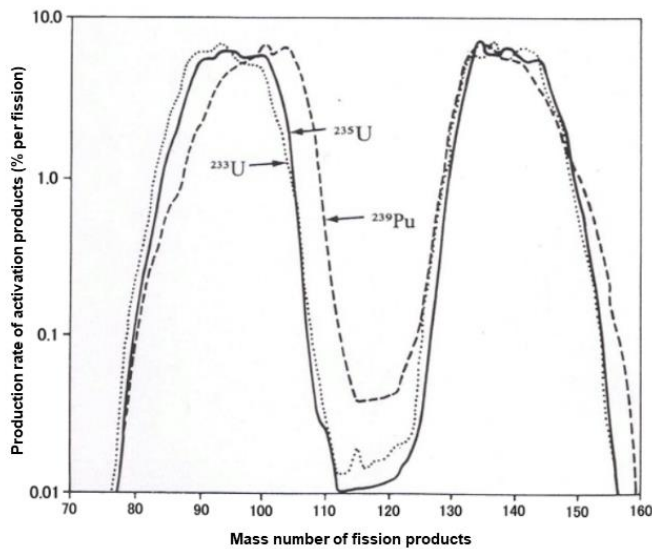

Figure 1.1.3-2 Fission of uranium, and production and fission of plutonium



Based on the ATOMICA's "atomic mass number distribution of fission products."
 Source: W. Marshall, ed.: Development of Reactor Technology (Vol.1), Shoukabou, p. 72

Figure 1.1.3-3 Distribution of mass numbers of fission products

2.2 Assessment of activation products

[Excerpt from the Supplementary Explanation of the Implementation Plan for the ALPS Treated Water Dilution/ Discharge Facilities and Related Facilities (July 2022)]

In the assessment of activation products, studies on decommissioning and disposal facilities will be used as a reference, and inventories as of March 2011 will be assessed, while taking into account the irradiation period from the core, for four kinds of equipment and structures: reactor internals, fuel assemblies (excluding nuclear fuel materials), pressure vessels, and pedestals, which exist in the reactor pressure vessels and lower part of them. In addition, inventories as of March of 2011 of corrosion products which will be produced as a result of corrosion and activation of materials comprising the equipment of the reactor coolant system will be assessed as well using water supply and metal data during operation, etc. In both of the assessments, for the period after March 2011, reduction in inventories due to decay over 12 years will be calculated.

Regarding reactor internals and fuel assemblies, rather than assessing all pieces of equipment, when same materials are used, those that are closer to the core (larger activation amount) will be selected for assessment to be conservative.

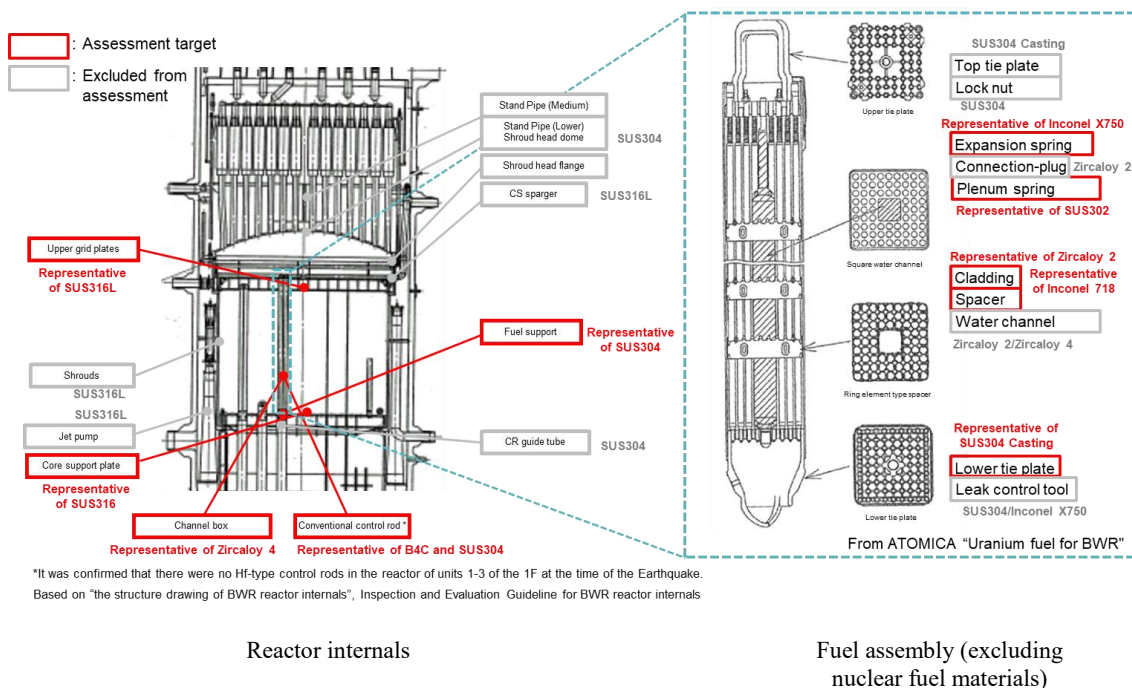

Figure 1.1.3-4 Targets of the inventory assessment, such as reactor internals

2.3 Inventory assessment results

Tables 1.1.3.1 to 3 show the results of the inventory assessment performed under the conditions described in section 2.1 and 2.2.

In the assessment of fission products, all of the inventories produced from fuel are taken into account. When assessing the inventories of fission products, only inventories produced from fuel are taken into account and the presence of combustible poisons is not considered as is the case with normal nuclear power plant safety assessments and in the examination of nuclides subject to removal by ALPS.

In the assessment of activation products, the inventory is calculated from the reactor pressure vessel and pedestal in addition to the upper grid plates, channel box, fuel assembly (all components), conventional control rods, fuel support, and core support plate which exist in the core while the reactor is in operation and assumed to have melted through past investigations and accident analyses. The activation of each piece of equipment are assessed based on operation records and conditions (element concentration condition, neutron flux) for waste subject to marginal depth disposal (L1), high-level radioactive waste (vitrified waste) and hull wastes^{*1}, which have been studied by the Electric Technology Research Association.

In the assessment of inventories using ORIGEN, as is the case with past safety assessments and research of decommissioning, the inventories such as the fuel, channel box, fuel assembly, and conventional control rods, which can be assessed by point kinetics of neutron flux in reactors, are assessed by ORIGEN2, while upper grid, core support plate, fuel support, reactor pressure vessel and pedestal, whose neutron spectrum is different from that of fuel, are assessed by SCALE5.1/ORIGEN-S. The data embedded in JENDL4.0 and SCALE5.1 are used as nuclear data respectively.

*1: When spent nuclear fuel is reprocessed through the Purex method, nuclear fuel is made into thin fragments by chopping it, and the clad waste material of the nuclear fuel is called the hull (from ATOMICA).

Table 1.1.3-1 Inventory assessment results: Unit 1 (1/3)

Nuclide	Radioactivity [Bq]	Nuclide	Radioactivity [Bq]	Nuclide	Radioactivity [Bq]
H-3	4.8E+14	Nb-94	1.9E+11	Te-123m	1.5E+04
Be-10	8.4E+08	Mo-93	2.4E+11	Te-125m	2.9E+14
C-14	5.4E+12	Tc-97	2.9E+06	Te-127	7.8E+03
Na-22	3.6E+07	Tc-98	9.6E+06	Te-127m	8.0E+03
Si-32	7.1E+05	Tc-99	2.7E+13	I-129	4.9E+10
P-32	7.1E+05	Ru-106	2.1E+14	Cs-134	6.9E+15
Cl-36	5.1E+09	Rh-101	1.1E+05	Cs-135	1.1E+12
Ar-39	1.7E+11	Rh-102	7.1E+06	Cs-137	1.5E+17
Ar-42	4.9E+03	Rh-102m	1.6E+07	Ba-133	5.0E+10
K-40	1.6E+08	Rh-106	2.1E+14	Ba-137m	1.5E+17
K-42	4.9E+03	Pd-107	1.9E+11	La-137	1.4E+07
Ca-41	3.5E+09	Ag-108	3.3E+09	La-138	3.1E+04
Ca-45	4.8E+06	Ag-108m	3.8E+10	Ce-139	5.4E+03
Sc-46	3.7E+01	Ag-109m	8.8E+09	Ce-142	5.3E+07
V-49	2.3E+04	Ag-110	3.5E+08	Ce-144	4.1E+13
Mn-54	4.1E+11	Ag-110m	2.6E+10	Pr-144	4.1E+13
Fe-55	2.6E+15	Cd-109	8.8E+09	Pr-144m	6.2E+11
Co-60	8.1E+15	Cd-113m	2.5E+13	Nd-144	3.3E+03
Ni-59	1.4E+13	In-113m	1.7E+04	Pm-144	2.8E+01
Ni-63	1.6E+15	In-115	4.5E+03	Pm-145	1.8E+10
Zn-65	9.9E+08	Sn-113	1.7E+04	Pm-146	1.0E+12
Se-75	1.0E+03	Sn-119m	1.6E+10	Pm-147	1.5E+16
Se-79	1.1E+11	Sn-121	2.1E+13	Sm-145	3.1E+07
Kr-81	1.1E+10	Sn-121m	2.7E+13	Sm-146	2.3E+05
Kr-85	9.2E+15	Sn-123	1.1E+05	Sm-147	1.3E+07
Rb-87	9.4E+07	Sn-126	4.8E+11	Sm-148	8.2E+01
Sr-90	1.1E+17	Sb-125	7.9E+14	Sm-149	1.5E+00
Y-90	1.1E+17	Sb-126	6.8E+10	Sm-151	5.7E+14
Zr-93	3.9E+12	Sb-126m	4.8E+11	Eu-150	3.9E+07
Nb-91	1.0E+05	Te-121	6.1E+02	Eu-152	2.8E+12
Nb-92	1.7E+06	Te-121m	6.1E+02	Eu-154	3.8E+15
Nb-93m	1.8E+12	Te-123	1.3E+04	Eu-155	1.1E+15

Table 1.1.3-1 Inventory assessment results: Unit 1 (2/3)

Nuclide	Radioactivity [Bq]	Nuclide	Radioactivity [Bq]	Nuclide	Radioactivity [Bq]
Gd-152	4.3E+00	Pb-212	3.8E+10	Th-228	3.8E+10
Gd-153	3.2E+08	Pb-214	5.2E+06	Th-229	4.6E+05
Tb-157	6.8E+08	Bi-208	6.5E+05	Th-230	6.8E+08
Tb-158	6.9E+08	Bi-210	1.8E+06	Th-231	8.4E+10
Dy-159	1.9E+01	Bi-210m	1.7E+05	Th-232	6.3E+06
Ho-163	1.5E+07	Bi-211	2.2E+07	Th-234	8.0E+11
Ho-166m	6.9E+09	Bi-212	3.8E+10	Pa-231	7.6E+07
Tm-170	5.0E+05	Bi-213	4.6E+05	Pa-233	5.0E+11
Tm-171	1.4E+12	Bi-214	5.2E+06	Pa-234	1.0E+09
Lu-176	5.1E+05	Po-210	1.8E+06	Pa-234m	8.0E+11
Lu-177	4.7E+05	Po-211	6.2E+04	U-232	3.9E+10
Lu-177m	2.0E+06	Po-212	2.4E+10	U-233	1.1E+08
Hf-182	2.1E+06	Po-213	4.6E+05	U-234	3.4E+12
Ta-182	2.2E+06	Po-214	5.2E+06	U-235	8.4E+10
W-181	8.3E+02	Po-215	2.2E+07	U-236	5.6E+11
Re-187	1.4E+06	Po-216	3.8E+10	U-237	3.0E+12
Os-194	1.4E+08	Po-218	5.2E+06	U-238	8.0E+11
Ir-192	5.7E+06	At-217	4.6E+05	U-240	5.7E+05
Ir-192m	5.7E+06	Rn-219	2.2E+07	Np-235	2.2E+06
Ir-194	1.4E+08	Rn-220	3.8E+10	Np-236	7.6E+06
Ir-194m	3.6E+03	Rn-222	5.2E+06	Np-237	5.0E+11
Pt-190	2.2E+03	Fr-221	4.6E+05	Np-238	7.9E+10
Pt-193	2.5E+12	Fr-223	3.1E+05	Np-239	2.7E+13
Tl-204	3.6E+12	Ra-223	2.2E+07	Np-240m	5.7E+05
Tl-206	1.7E+05	Ra-224	3.8E+10	Pu-236	3.3E+10
Tl-207	2.2E+07	Ra-225	4.6E+05	Pu-238	4.4E+15
Tl-208	1.4E+10	Ra-226	5.2E+06	Pu-239	6.7E+14
Tl-209	1.0E+04	Ra-228	6.2E+06	Pu-240	8.7E+14
Pb-205	5.1E+05	Ac-225	4.6E+05	Pu-241	1.2E+17
Pb-209	4.6E+05	Ac-227	2.2E+07	Pu-242	3.2E+12
Pb-210	1.8E+06	Ac-228	6.2E+06	Pu-243	2.2E+05
Pb-211	2.2E+07	Th-227	2.2E+07	Pu-244	5.7E+05

Table 1.1.3-1 Inventory assessment results: Unit 1 (3/3)

Nuclide	Radioactivity [Bq]	Nuclide	Radioactivity [Bq]	Nuclide	Radioactivity [Bq]
Am-241	3.5E+15	Cm-243	2.3E+13	Bk-249	1.8E+05
Am-242	1.6E+13	Cm-244	2.3E+15	Cf-249	5.4E+06
Am-242m	1.6E+13	Cm-245	4.0E+11	Cf-250	3.0E+07
Am-243	2.7E+13	Cm-246	6.9E+10	Cf-251	3.1E+05
Am-245	2.6E+00	Cm-247	2.2E+05	Cf-252	4.3E+06
Cm-242	1.3E+13	Cm-248	5.9E+05		

Table 1.1.3-2 Inventory assessment results: Unit 2 (1/3)

Nuclide	Radioactivity [Bq]	Nuclide	Radioactivity [Bq]	Nuclide	Radioactivity [Bq]
H-3	6.1E+14	Nb-93m	2.3E+12	Te-123	1.2E+04
Be-10	1.1E+09	Nb-94	3.6E+11	Te-123m	2.0E+04
C-14	9.8E+12	Mo-93	6.0E+11	Te-125m	3.9E+14
Na-22	5.0E+07	Tc-97	4.1E+06	Te-127	1.2E+04
Si-32	1.5E+06	Tc-98	1.1E+07	Te-127m	1.2E+04
P-32	1.5E+06	Tc-99	3.4E+13	I-129	5.9E+10
Cl-36	1.3E+10	Ru-106	2.8E+14	Cs-134	9.1E+15
Ar-39	2.4E+11	Rh-101	1.5E+05	Cs-135	1.2E+12
Ar-42	1.3E+04	Rh-102	9.7E+06	Cs-137	1.9E+17
K-40	1.5E+08	Rh-102m	2.1E+07	Ba-133	6.0E+10
K-42	1.3E+04	Rh-106	2.8E+14	Ba-137m	1.8E+17
Ca-41	6.8E+09	Pd-107	2.2E+11	La-137	1.7E+07
Ca-45	6.8E+06	Ag-108	5.8E+09	La-138	4.1E+04
Sc-46	5.2E+01	Ag-108m	6.7E+10	Ce-139	7.5E+03
V-49	3.8E+04	Ag-109m	1.3E+10	Ce-142	6.7E+07
Mn-54	5.8E+11	Ag-110	4.5E+08	Ce-144	6.4E+13
Fe-55	4.2E+15	Ag-110m	3.3E+10	Pr-144	6.4E+13
Co-60	1.4E+16	Cd-109	1.3E+10	Pr-144m	9.7E+11
Ni-59	2.9E+13	Cd-113m	2.9E+13	Nd-144	4.1E+03
Ni-63	3.4E+15	In-113m	2.4E+04	Pm-144	3.8E+01
Zn-65	1.5E+09	In-115	4.9E+03	Pm-145	3.0E+10
Se-75	1.5E+03	Sn-113	2.4E+04	Pm-146	1.3E+12
Se-79	1.3E+11	Sn-119m	2.2E+10	Pm-147	2.1E+16
Kr-81	1.7E+10	Sn-121	2.6E+13	Sm-145	4.4E+07
Kr-85	1.2E+16	Sn-121m	3.3E+13	Sm-146	2.5E+05
Rb-87	1.1E+08	Sn-123	1.6E+05	Sm-147	1.7E+07
Sr-90	1.5E+17	Sn-126	5.8E+11	Sm-148	9.4E+01
Y-88	1.1E+00	Sb-125	1.1E+15	Sm-149	2.3E+00
Y-90	1.5E+17	Sb-126	8.1E+10	Sm-151	7.8E+14
Zr-93	4.9E+12	Sb-126m	5.8E+11	Eu-150	4.1E+07
Nb-91	4.1E+05	Te-121	9.3E+02	Eu-152	3.1E+12
Nb-92	3.8E+06	Te-121m	9.3E+02	Eu-154	4.6E+15

Table 1.1.3-2 Inventory assessment results: Unit 2 (2/3)

Nuclide	Radioactivity [Bq]	Nuclide	Radioactivity [Bq]	Nuclide	Radioactivity [Bq]
Eu-155	1.4E+15	Pb-211	2.5E+07	Th-227	2.5E+07
Gd-152	4.7E+00	Pb-212	4.2E+10	Th-228	4.2E+10
Gd-153	3.8E+08	Pb-214	5.5E+06	Th-229	4.4E+05
Tb-157	9.5E+08	Bi-208	9.1E+05	Th-230	8.7E+08
Tb-158	7.6E+08	Bi-210	1.7E+06	Th-231	1.4E+11
Dy-159	2.5E+01	Bi-210m	2.4E+05	Th-232	5.9E+06
Ho-163	2.2E+07	Bi-211	2.5E+07	Th-234	1.1E+12
Ho-166m	9.5E+09	Bi-212	4.2E+10	Pa-231	9.4E+07
Tm-170	7.0E+05	Bi-213	4.4E+05	Pa-233	6.2E+11
Tm-171	1.9E+12	Bi-214	5.5E+06	Pa-234	1.5E+09
Lu-176	7.2E+05	Po-210	1.7E+06	Pa-234m	1.1E+12
Lu-177	6.5E+05	Po-211	7.1E+04	U-232	4.4E+10
Lu-177m	2.8E+06	Po-212	2.7E+10	U-233	1.5E+08
Hf-182	2.9E+06	Po-213	4.3E+05	U-234	5.1E+12
Ta-182	3.0E+06	Po-214	5.5E+06	U-235	1.4E+11
W-181	1.2E+03	Po-215	2.5E+07	U-236	7.3E+11
Re-187	2.2E+06	Po-216	4.2E+10	U-237	3.6E+12
Os-194	2.0E+08	Po-218	5.5E+06	U-238	1.1E+12
Ir-192	6.9E+06	At-217	4.4E+05	U-240	6.1E+05
Ir-192m	6.9E+06	Rn-219	2.5E+07	Np-235	2.8E+06
Ir-194	2.0E+08	Rn-220	4.2E+10	Np-236	9.4E+06
Ir-194m	4.4E+03	Rn-222	5.5E+06	Np-237	6.2E+11
Pt-190	2.1E+03	Fr-221	4.4E+05	Np-238	7.7E+10
Pt-193	3.6E+12	Fr-223	3.5E+05	Np-239	2.8E+13
Tl-204	5.4E+12	Ra-223	2.5E+07	Np-240m	6.1E+05
Tl-206	2.4E+05	Ra-224	4.2E+10	Pu-236	4.0E+10
Tl-207	2.5E+07	Ra-225	4.4E+05	Pu-238	4.8E+15
Tl-208	1.5E+10	Ra-226	5.5E+06	Pu-239	8.7E+14
Tl-209	9.5E+03	Ra-228	5.8E+06	Pu-240	1.1E+15
Pb-205	1.2E+06	Ac-225	4.4E+05	Pu-241	1.5E+17
Pb-209	4.4E+05	Ac-227	2.5E+07	Pu-242	3.4E+12
Pb-210	1.7E+06	Ac-228	5.8E+06	Pu-243	1.9E+05

Table 1.1.3-2 Inventory assessment results: Unit 2 (3/3)

Nuclide	Radioactivity [Bq]	Nuclide	Radioactivity [Bq]	Nuclide	Radioactivity [Bq]
Pu-244	6.1E+05	Cm-242	1.3E+13	Cm-248	4.8E+05
Am-241	4.1E+15	Cm-243	2.3E+13	Bk-249	1.5E+05
Am-242	1.5E+13	Cm-244	2.2E+15	Cf-249	4.5E+06
Am-242m	1.5E+13	Cm-245	3.9E+11	Cf-250	2.5E+07
Am-243	2.8E+13	Cm-246	6.1E+10	Cf-251	2.5E+05
Am-245	2.2E+00	Cm-247	1.9E+05	Cf-252	3.3E+06

Table 1.1.3-3 Inventory assessment results: Unit 3 (1/3)

Nuclide	Radioactivity [Bq]	Nuclide	Radioactivity [Bq]	Nuclide	Radioactivity [Bq]
H-3	5.7E+14	Nb-93m	2.2E+12	Te-123	1.2E+04
Be-10	1.1E+09	Nb-94	3.6E+11	Te-123m	2.0E+04
C-14	9.8E+12	Mo-93	6.1E+11	Te-125m	3.8E+14
Na-22	5.0E+07	Tc-97	4.1E+06	Te-127	1.2E+04
Si-32	1.5E+06	Tc-98	1.0E+07	Te-127m	1.2E+04
P-32	1.5E+06	Tc-99	3.2E+13	I-129	5.6E+10
Cl-36	1.3E+10	Ru-106	2.7E+14	Cs-134	8.6E+15
Ar-39	2.4E+11	Rh-101	1.5E+05	Cs-135	1.2E+12
Ar-42	1.3E+04	Rh-102	9.4E+06	Cs-137	1.8E+17
K-40	1.5E+08	Rh-102m	2.0E+07	Ba-133	5.6E+10
K-42	1.3E+04	Rh-106	2.7E+14	Ba-137m	1.7E+17
Ca-41	6.8E+09	Pd-107	2.0E+11	La-137	1.6E+07
Ca-45	6.8E+06	Ag-108	5.8E+09	La-138	4.1E+04
Sc-46	5.2E+01	Ag-108m	6.7E+10	Ce-139	6.9E+03
V-49	3.8E+04	Ag-109m	1.3E+10	Ce-142	6.3E+07
Mn-54	6.1E+11	Ag-110	4.1E+08	Ce-144	6.2E+13
Fe-55	4.4E+15	Ag-110m	3.0E+10	Pr-144	6.2E+13
Co-60	1.4E+16	Cd-109	1.3E+10	Pr-144m	9.4E+11
Ni-59	3.0E+13	Cd-113m	2.8E+13	Nd-144	3.9E+03
Ni-63	3.4E+15	In-113m	2.4E+04	Pm-144	3.7E+01
Zn-65	1.5E+09	In-115	4.9E+03	Pm-145	3.0E+10
Se-75	1.5E+03	Sn-113	2.4E+04	Pm-146	1.2E+12
Se-79	1.3E+11	Sn-119m	2.2E+10	Pm-147	2.0E+16
Kr-81	1.7E+10	Sn-121	2.4E+13	Sm-145	4.4E+07
Kr-85	1.1E+16	Sn-121m	3.1E+13	Sm-146	2.3E+05
Rb-87	1.1E+08	Sn-123	1.7E+05	Sm-147	1.6E+07
Sr-90	1.4E+17	Sn-126	5.5E+11	Sm-148	8.6E+01
Y-88	1.0E+00	Sb-125	1.0E+15	Sm-149	2.3E+00
Y-90	1.4E+17	Sb-126	7.7E+10	Sm-151	8.0E+14
Zr-93	4.7E+12	Sb-126m	5.5E+11	Eu-150	3.8E+07
Nb-91	4.1E+05	Te-121	9.3E+02	Eu-152	3.1E+12
Nb-92	3.9E+06	Te-121m	9.3E+02	Eu-154	4.2E+15

Table 1.1.3-3 Inventory assessment results: Unit 3 (2/3)

Nuclide	Radioactivity [Bq]	Nuclide	Radioactivity [Bq]	Nuclide	Radioactivity [Bq]
Eu-155	1.3E+15	Pb-211	2.4E+07	Th-227	2.4E+07
Gd-152	4.6E+00	Pb-212	3.8E+10	Th-228	3.8E+10
Gd-153	3.6E+08	Pb-214	5.5E+06	Th-229	4.0E+05
Tb-157	9.5E+08	Bi-208	9.1E+05	Th-230	8.6E+08
Tb-158	6.8E+08	Bi-210	1.8E+06	Th-231	1.4E+11
Dy-159	2.5E+01	Bi-210m	2.4E+05	Th-232	5.9E+06
Ho-163	2.2E+07	Bi-211	2.4E+07	Th-234	1.1E+12
Ho-166m	9.2E+09	Bi-212	3.8E+10	Pa-231	9.0E+07
Tm-170	7.0E+05	Bi-213	4.0E+05	Pa-233	5.8E+11
Tm-171	1.9E+12	Bi-214	5.5E+06	Pa-234	1.4E+09
Lu-176	7.2E+05	Po-210	1.8E+06	Pa-234m	1.1E+12
Lu-177	6.5E+05	Po-211	6.8E+04	U-232	3.9E+10
Lu-177m	2.8E+06	Po-212	2.4E+10	U-233	1.4E+08
Hf-182	2.9E+06	Po-213	3.9E+05	U-234	5.1E+12
Ta-182	3.0E+06	Po-214	5.5E+06	U-235	1.4E+11
W-181	1.2E+03	Po-215	2.4E+07	U-236	7.0E+11
Re-187	2.2E+06	Po-216	3.8E+10	U-237	4.0E+12
Os-194	2.0E+08	Po-218	5.5E+06	U-238	1.1E+12
Ir-192	6.9E+06	At-217	4.0E+05	U-240	5.5E+05
Ir-192m	6.9E+06	Rn-219	2.4E+07	Np-235	2.5E+06
Ir-194	2.0E+08	Rn-220	3.8E+10	Np-236	8.6E+06
Ir-194m	4.4E+03	Rn-222	5.5E+06	Np-237	5.8E+11
Pt-190	2.1E+03	Fr-221	4.0E+05	Np-238	3.0E+11
Pt-193	3.6E+12	Fr-223	3.4E+05	Np-239	2.9E+13
Tl-204	5.4E+12	Ra-223	2.4E+07	Np-240m	5.5E+05
Tl-206	2.4E+05	Ra-224	3.8E+10	Pu-236	3.6E+10
Tl-207	2.4E+07	Ra-225	4.0E+05	Pu-238	6.7E+15
Tl-208	1.4E+10	Ra-226	5.5E+06	Pu-239	1.1E+15
Tl-209	8.6E+03	Ra-228	5.9E+06	Pu-240	1.4E+15
Pb-205	1.2E+06	Ac-225	4.0E+05	Pu-241	1.6E+17
Pb-209	4.0E+05	Ac-227	2.4E+07	Pu-242	4.6E+12
Pb-210	1.8E+06	Ac-228	5.9E+06	Pu-243	1.3E+05

Table 1.1.3-3 Inventory assessment results: Unit 3 (3/3)

Nuclide	Radioactivity [Bq]	Nuclide	Radioactivity [Bq]	Nuclide	Radioactivity [Bq]
Pu-244	5.5E+05	Cm-242	4.9E+13	Cm-248	3.3E+05
Am-241	5.6E+15	Cm-243	2.9E+13	Bk-249	1.0E+05
Am-242	5.9E+13	Cm-244	1.9E+15	Cf-249	3.0E+06
Am-242m	5.9E+13	Cm-245	3.1E+11	Cf-250	1.6E+07
Am-243	2.9E+13	Cm-246	4.6E+10	Cf-251	1.6E+05
Am-245	1.5E+00	Cm-247	1.3E+05	Cf-252	2.0E+06

2.4 Uncertainty in inventory assessment

In this assessment, the study is based on the conditions for marginal depth disposal waste (L1), high-level radioactive waste (vitrified waste), and hull waste, as examined in safety assessments of normal nuclear power plants, the study of the nuclides to be removed by ALPS, and joint research by electric power companies. However, some conditions include uncertainty in the input conditions, and therefore, there is uncertainty in the assessment results.

The details of the input conditions and uncertainties are shown in Table 1.1.3-4. As to fission products, uncertainties due to the input conditions hardly exist, and we believe realistic evaluations can be performed, but as for activation products, there is uncertainty in the elemental concentration condition, etc., on the conservative side.

Table 1.1.3-4 Uncertainty in inventory assessment

Condition		Input state	Uncertainty
Assessment of fission products	Fuel type	Data of fuel loaded in the reactor core of Units 1 - 3 of Fukushima Daiichi NPS on March 11, 2011	Small
	Uranium weight		
	Enrichment		
	Fuel composition	U-234: U-235 enrichment × 0.008 (natural composition ratio) U-235: From the enrichment of the fuel data U-238: Difference from weight% of U-234, U-235	Small
	Burnup	Burnup of each fuel assembly as of March 11, 2011	Small
	Irradiation condition	Continuous operation at 100% thermal output without considering periodic inspection	Small*1
	Cooling period	12 years (from March 11, 2023)	Small
Assessment of activation products	Equipment to be evaluated and equipment weight	Fuel assembly : Total weight Channel box (CB) : Total weight of each piece of equipment Control rod (CR) Other structural materials RPV : Total weight x 25% Pedestal : Set from IRID's subsidized project "Sophistication of assessing conditions inside reactors by accident progress analysis and actual equipment data, etc." (about 160 tons/unit). Corrosion products : The results of the past 4 cycles of metals brought in from the water supply (without consideration of removal by the reactor coolant clean-up system).	Small to large*2
	Element concentration condition	For each piece of equipment, we consider the principal components and impurity components regulated by material standards and other regulations, as well as minor components not controlled by these regulations, based on past joint research by electric power companies. Based on this concept, the targets are 83 elements, excluding radioelements (20 elements) other than Bi, Th, and U from atomic numbers 1 - 103 of the periodic table of elements. In this evaluation, element concentration conditions are set, excluding rare gases.	Large*3
	Amount of irradiation/ neutron flux and irradiation period	Fuel assembly/CB : Set equal to the average fuel burnup CR : Set with a margin in the results of CR irradiation amount (overall average) of 1F-1 to 3. Other structural materials : Calculated from the neutron flux at the center of the equipment and the duration of its presence in the reactor. RPV and pedestal : Calculated from neutron flux and service life at the center of each equipment and structure. Corrosion products : Calculated by the loading period (4 cycles) of the cladding into the reactor, assuming neutron flux and adhesion when the cladding adheres.	Small to medium
	Irradiation condition	Continuous operation at 100% thermal output without considering periodic inspection	Small*1
	Cooling period	12 years (from March 11, 2023)	Small

*1: It is a nuclide with a short half-life, and it is conservative but has little impact after a cooling period of 12 years.

*2: Though the weight actually contributed is unknown, it is set to the weight in the above table from diagrams, etc.

*3: The concentration of the element listed in the standard is set at the maximum value, and even for the minor component which is not controlled by the standard, it is set conservatively from the survey in the past, or the conservative initial condition is set for the minor component which has not been investigated.

Code used for inventory calculations (ORIGEN-2)

1. Overview

ORIGEN-2 is a burn-up calculation code based on point kinetics of neutron flux in reactors which was developed by Oak Ridge National Laboratory (ORNL). ORIGEN-2 is a versatile analysis code and is widely used for the calculation of decay heat of transportation casks, etc.

2. Functions

ORIGEN-2 has the following functions for burn-up analysis.

- [1] It can calculate decay heat, radioactive intensity, radioactivity of nuclides according to the cooling period by calculating burn-up of fuel in reactors and calculating decay after removal from reactors.
- [2] It allows free selection from the built-in cross section libraries for reactor type-fuel combinations which have been weighted in accordance with the difference in neutron energy spectrum.
- [3] Calculation results to be output are classified into activation products, actinoids, fission products.
- [4] Regarding radionuclide data (decay heat, energy distribution of gamma rays, neutron source intensity generated by spontaneous fission and (alpha, n) reactions, etc.) necessary for burn-up calculation, libraries exclusive to ORIGEN-2 are available and used for calculation.

3. Calculation flow

Figure 1.1.3-5 shows the calculation flow of ORIGEN-2.

4. Application record

ORIGEN-2 is widely used for the calculation of decay heat of transportation casks and fuel facilities.

5. Verification method

It has been confirmed that the introduction of the versatile code has been evaluated*¹. It has been confirmed that a verification*² has been conducted through large-scale experiments and benchmark tests.

*1: A.G.Croff, "ORIGEN2 Isotope Generation and Depletion Code MATRIX EXPONENTIAL METHOD", CCC-371(1987)

*2: Atomic Energy Society of Japan "Reactor decay heat and its recommended values" August 1989.

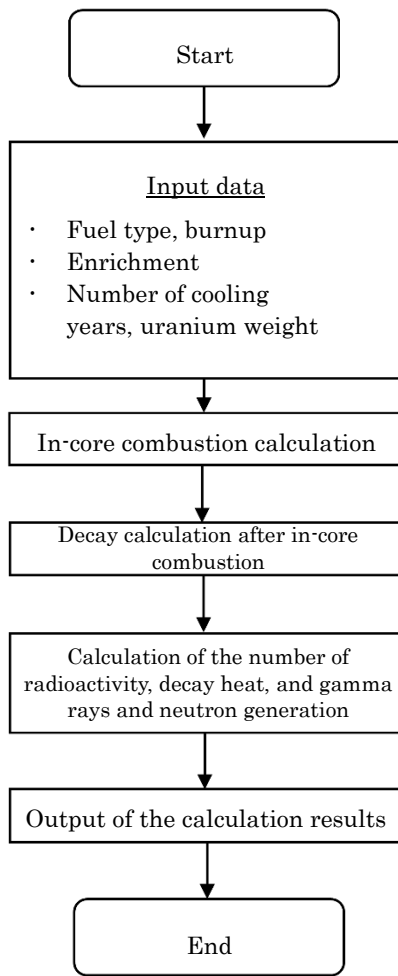

Figure 1.1.3-5 Calculation flow of ORIGEN-2

End

The code used for inventory calculations (ORIGEN-S)

1. Overview

SCALE 5.1/ORIGEN-S (hereinafter, ORIGEN-S) is an activation calculation code developed by Oak Ridge National Laboratory (ORNL) in the United States, which can use three groups of spectra—fast neutron, epithermal neutron and thermal neutron. ORIGEN-S is a versatile analysis code and is widely used for the calculation of activation of reactor internals and for decommissioning of reactor facilities, etc.

2. Functions

ORIGEN-S is capable of calculating the following.

- [1] Calculates the radioactivity of nuclides, number of neutrons and gamma rays produced, production of fission products and actinoids by inputting fuel nuclide composition (weight), irradiation period (operation pattern), neutron flux or specific power of the reactor.
- [2] Calculates activation activity of structure materials by inputting the material composition, neutron flux and irradiation record of the structure material to be assessed.
- [3] Calculates energy deposition of radionuclides to be obtained by production and annihilation calculation by inputting the material composition, neutron flux and irradiation record of the structural material to be assessed.

3. Calculation flow

Figure 1.1.3-6 shows the calculation flow of ORIGEN-S.

4. Application record

The ORIGEN-S is widely used for the activation calculation of reactor structures whose neutron spectrum is different from that of the fuel, and for the activation calculation of reactor pressure vessels and biological shielding materials for the purpose of decommissioning of reactor facilities.

5. Verification method

It has been confirmed that the introduction of the versatile code has been evaluated*¹. It has been confirmed that a verification*² has been conducted through large-scale experiments and benchmark tests.

*1: SCALE: A Modular Code System for Performing Standardized Computer Analyses for Licensing Evaluation, ORNL/TM-2005/39, Version 5.1, Vols.I–III, November (2006)

*2: K.Tanaka et al., “Radioactivity evaluation for Main Steam Line and Suppression Chamber of small type BWR”, Progress in Nuclear Science and Technology Volume 4 (2014) pp.836-839

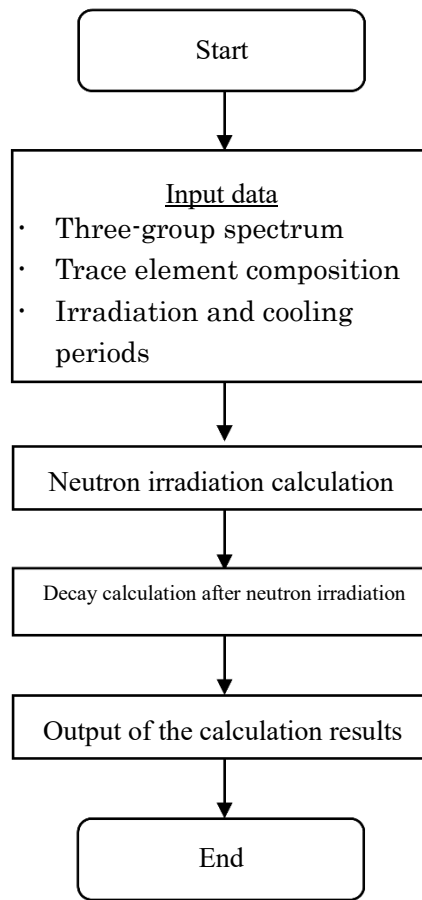

Figure 1.1.3-6 Calculation flow of ORIGEN-S

Supplementary explanation on the selection of nuclides in the examination of nuclides to be measured and assessed at the discharge of ALPS treated water into the sea

1. Overview

Attachments-2 and 3 provide supplementary explanations on the nuclide analysis and inventory assessment which are performed in order to ensure that the sum of the ratios to regulatory concentration limits of radionuclides other than tritium in ALPS treated water is less than 1 while taking into account previous studies on decommissioning and disposal facilities in Japan. This document supplements the explanation about how to select nuclides to be measured and assessed at the discharge of ALPS treated water into the sea based on the results obtained through the nuclide analysis and inventory assessment.

2. How to select nuclides to be measured and assessed

The nuclides to be measured and assessed at the discharge of ALPS treated water into the sea will be selected in accordance with the flow shown in Figure 1.1.4-1. This section gives supplementary explanations about each steps of the procedures.

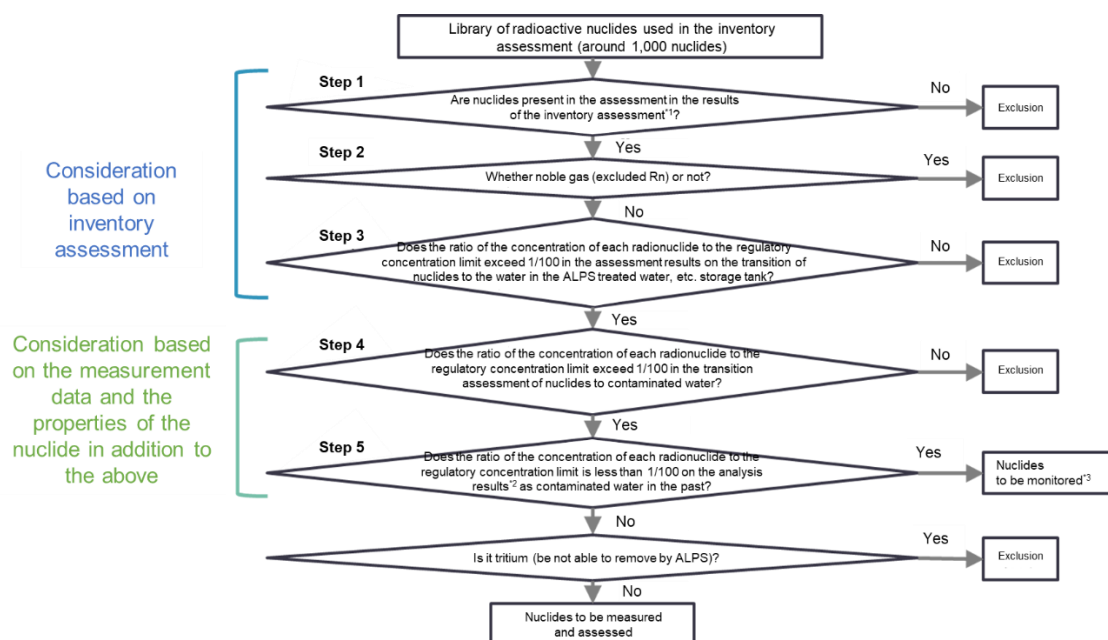

*1: The decay period of the inventory evaluation is appropriately set according to the time when the selection result is to be used. (First time set to 2023 (12 years after the accident))

*2: Nuclides that have been detected in the past are confirmed by the maximum value of the detection value, and nuclides that have never been detected are confirmed by the minimum value of the detection limit value

*3: Nuclides that shall be continuously confirmed if significantly exists in contaminated water.

Figure 1.1.4-1 Flowchart for selection of nuclides to be measured and assessed for discharge of ALPS treated water into the sea

2.1 Step 1

In Step 1 “Are nuclides present in the assessment in the results of the inventory assessment? ,” nuclides will be evaluated by the criteria whether they are found to exist through the inventory assessment (if 1 Bq or more of the nuclide exists in each core of Units 1 to 3), and nuclides that are not found to exist through the assessment will be excluded.

In the selection flow, it is stated that the decay period for the inventory assessment shall be set appropriately. In the assessment this time, the decay period is set to March 2023, 12 years after the earthquake when the discharge of ALPS treated water into the sea starts.

As a result, the 210 nuclides that are shown in Table 1.1.4-1 were found to exist (See Attachment-3 for details about the inventory assessment).

Table 1.1.4-1 Nuclides that were found to exist through Step 1 (1/2)

No.	Nuclide	No.	Nuclide	No.	Nuclide	No.	Nuclide	No.	Nuclide
1	H-3	21	Zn-65	41	Rh-102	61	Sb-126	81	Pr-144
2	Be-10	22	Se-75	42	Rh-102m	62	Sb-126m	82	Pr-144m
3	C-14	23	Se-79	43	Rh-106	63	Te-121	83	Nd-144
4	Na-22	24	Kr-81	44	Pd-107	64	Te-121m	84	Pm-144
5	Si-32	25	Kr-85	45	Ag-108	65	Te-123	85	Pm-145
6	P-32	26	Rb-87	46	Ag-108m	66	Te-123m	86	Pm-146
7	Cl-36	27	Sr-90	47	Ag-109m	67	Te-125m	87	Pm-147
8	Ar-39	28	Y-88	48	Ag-110	68	Te-127	88	Sm-145
9	Ar-42	29	Y-90	49	Ag-110m	69	Te-127m	89	Sm-146
10	K-40	30	Zr-93	50	Cd-109	70	I-129	90	Sm-147
11	K-42	31	Nb-91	51	Cd-113m	71	Cs-134	91	Sm-148
12	Ca-41	32	Nb-92	52	In-113m	72	Cs-135	92	Sm-149
13	Ca-45	33	Nb-93m	53	In-115	73	Cs-137	93	Sm-151
14	Sc-46	34	Nb-94	54	Sn-113	74	Ba-133	94	Eu-150
15	V-49	35	Mo-93	55	Sn-119m	75	Ba-137m	95	Eu-152
16	Mn-54	36	Tc-97	56	Sn-121	76	La-137	96	Eu-154
17	Fe-55	37	Tc-98	57	Sn-121m	77	La-138	97	Eu-155
18	Co-60	38	Tc-99	58	Sn-123	78	Ce-139	98	Gd-152
19	Ni-59	39	Ru-106	59	Sn-126	79	Ce-142	99	Gd-153
20	Ni-63	40	Rh-101	60	Sb-125	80	Ce-144	100	Tb-157

Table 1.1.4-1 Nuclides that were found to exist through Step 1 (2/2)

No.	Nuclide	No.	Nuclide	No.	Nuclide	No.	Nuclide	No.	Nuclide
101	Tb-158	123	Tl-207	145	Po-216	167	Th-234	189	Pu-240
102	Dy-159	124	Tl-208	146	Po-218	168	Pa-231	190	Pu-241
103	Ho-163	125	Tl-209	147	At-217	169	Pa-233	191	Pu-242
104	Ho-166m	126	Pb-205	148	Rn-219	170	Pa-234	192	Pu-243
105	Tm-170	127	Pb-209	149	Rn-220	171	Pa-234m	193	Pu-244
106	Tm-171	128	Pb-210	150	Rn-222	172	U-232	194	Am-241
107	Lu-176	129	Pb-211	151	Fr-221	173	U-233	195	Am-242
108	Lu-177	130	Pb-212	152	Fr-223	174	U-234	196	Am-242m
109	Lu-177m	131	Pb-214	153	Ra-223	175	U-235	197	Am-243
110	Hf-182	132	Bi-208	154	Ra-224	176	U-236	198	Am-245
111	Ta-182	133	Bi-210	155	Ra-225	177	U-237	199	Cm-242
112	W-181	134	Bi-210m	156	Ra-226	178	U-238	200	Cm-243
113	Re-187	135	Bi-211	157	Ra-228	179	U-240	201	Cm-244
114	Os-194	136	Bi-212	158	Ac-225	180	Np-235	202	Cm-245
115	Ir-192	137	Bi-213	159	Ac-227	181	Np-236	203	Cm-246
116	Ir-192m	138	Bi-214	160	Ac-228	182	Np-237	204	Cm-247
117	Ir-194	139	Po-210	161	Th-227	183	Np-238	205	Cm-248
118	Ir-194m	140	Po-211	162	Th-228	184	Np-239	206	Bk-249
119	Pt-190	141	Po-212	163	Th-229	185	Np-240m	207	Cf-249
120	Pt-193	142	Po-213	164	Th-230	186	Pu-236	208	Cf-250
121	Tl-204	143	Po-214	165	Th-231	187	Pu-238	209	Cf-251
122	Tl-206	144	Po-215	166	Th-232	188	Pu-239	210	Cf-252

2.2 Step 2

In Step 2 "Whether noble gas (excluded Rn) or not?," given that noble gas nuclides generated while the reactor is in operation are not considered to exist in the core due to the release at the time of operation and the earthquake and that, even if they exist, noble gas are stable elements and therefore insoluble in the contaminated water, they are judged not to fall within the scope of nuclides to be measured and assessed at the discharge of ALPS treated water into the sea and exclude. On the other hand, radon (Rn) is considered to still exist in the core due to the decay chains of uranium, neptunium, etc. Therefore, even though it is noble gas, it is not excluded in this step.

The rare gas nuclides identified in this step, except for Rn, are the following four nuclides, and Table 1.1.4-2 shows their half-lives and biosynthetic pathways which have been confirmed as well.

Table 1.1.4-2 Nuclides excluded in Step 2 and their biosynthetic pathways

Nuclides (rare gas)	Half-life [y]	Major biosynthetic pathway
Ar-39	2.7E+02	Produced by activation of trace component (K) in structural materials
Ar-42	3.3E+01	Produced by activation of trace component (K, Ca, etc.) in structural materials
Kr-81	2.3E+05	Produced by fission of fuel Produced by activation of trace component (Br) in structural materials
Kr-85	1.1E+02	Produced by fission of fuel

2.3 Step 3

In Step 3 "Does the ratio of the concentration of each radionuclide to the regulatory concentration limit exceed 1/100 in the assessment results on the transition of nuclides to the water in the ALPS treated water, etc. storage tank?," nuclides are evaluated to see whether their impacts on the dose assessment are sufficiently small or not (1/100 or less of ratio to the regulatory concentration limit), and nuclides with sufficiently small impact on the dose assessment are excluded by this criteria. This evaluation is performed under the assumption that all of the inventory existing in the PCV will have been dissolved in ALPS treated water, etc. tanks (prediction) as of March 2023*. Therefore, given the current status confirmed through the PCV inside investigation, an adequate level of conservativeness is secured under this assumption.

*: The same timing as for the inventory assessment will be adopted.

$$\text{Concentration of nuclide } i = \frac{\text{Inventory of nuclide } i \text{ (Bq)}}{\text{Amount of ALPS treated water, etc. stored (m}^3\text{)}} < \text{Regulatory concentration limit of nuclide } i \times 0.01 \text{ (Bq/cm}^3\text{)}$$

1.33 million m³ (estimated value) as of March 2023

In addition, it has been confirmed that the sum of the ratios to regulatory concentrations limits (assessed values) of the nuclides excluded in Step 3 is sufficiently small at 6.7E-02, compared to 2.4E+07, the sum of the ratios to regulatory concentrations limits (assessed values) of the nuclides that proceed to Step 4.

As a result, 93 nuclides proceed to Step 4, while 113 nuclides are excluded.

Table 1.1.4-3 Nuclides that proceed to Step 4 (93 nuclides)

No.	Nuclide	No.	Nuclide	No.	Nuclide	No.	Nuclide	No.	Nuclide
1	H-3	46	Ag-108m	81	Pr-144	159	Ac-227	189	Pu-240
3	C-14	49	Ag-110m	82	Pr-144m	162	Th-228	190	Pu-241
7	Cl-36	50	Cd-109	86	Pm-146	164	Th-230	191	Pu-242
16	Mn-54	51	Cd-113m	87	Pm-147	165	Th-231	194	Am-241
17	Fe-55	55	Sn-119m	93	Sm-151	167	Th-234	195	Am-242
18	Co-60	56	Sn-121	95	Eu-152	168	Pa-231	196	Am-242m
19	Ni-59	57	Sn-121m	96	Eu-154	169	Pa-233	197	Am-243
20	Ni-63	59	Sn-126	97	Eu-155	172	U-232	199	Cm-242
21	Zn-65	60	Sb-125	104	Ho-166m	173	U-233	200	Cm-243
23	Se-79	61	Sb-126	106	Tm-171	174	U-234	201	Cm-244
27	Sr-90	62	Sb-126m	120	Pt-193	175	U-235	202	Cm-245
29	Y-90	67	Te-125m	121	Tl-204	176	U-236	203	Cm-246
30	Zr-93	70	I-129	130	Pb-212	177	U-237	208	Cf-250
33	Nb-93m	71	Cs-134	136	Bi-212	178	U-238		
34	Nb-94	72	Cs-135	141	Po-212	182	Np-237		
35	Mo-93	73	Cs-137	145	Po-216	183	Np-238		
38	Tc-99	74	Ba-133	149	Rn-220	184	Np-239		
39	Ru-106	75	Ba-137m	153	Ra-223	186	Pu-236		
43	Rh-106	79	Ce-142	154	Ra-224	187	Pu-238		
44	Pd-107	80	Ce-144	157	Ra-228	188	Pu-239		

2.4 Step 4

2.4.1 Overview of evaluation of transfer to contaminated water

In Step 4 "Does the ratio of the concentration of each radionuclide to the regulatory concentration limit exceed 1/100 in the transition assessment of nuclides to contaminated water?," nuclides that have proceeded to Step 4 are grouped to the extent possible, and then "evaluation of transfer to contaminated water" is performed using actual analysis results to check if the impact on the dose assessment is sufficiently small (1/100 or less of the regulatory concentration limit), nuclides with a sufficiently small impact on the dose assessment are excluded in the relevant step.

Specifically, nuclides advanced to Step 4 are grouped according to their radioactive equilibrium, isotopes, the similarity of nuclide properties, etc., and the relative relationship of dose effects (inventory/regulatory concentration limit) is confirmed within the group, and nuclides with sufficiently small dose effects (relative ratio 1/100 or less) on representative nuclides are excluded. Then, based on the results of actual analysis of individual groups, the easiness of transfer into water is calculated by radionuclide (hereinafter, "transfer coefficient"). Then, the concentrations in contaminated water of individual radionuclides are evaluated using the coefficient. Concretely, the following equation is used for the evaluation.

$$\text{Evaluated concentration of radionuclides in contaminated water (Bq/L)} = \text{inventory}^{*1} \text{ (Bq)} \times \text{transfer coefficient}^{*2} \text{ (1/L)}$$

*1: In consideration of the timing when ALPS treated water is to be discharged into the sea, the evaluation result in 12 years after the earthquake is used.

*2: Calculated by the equation of Analysis result of contaminated water (Bq/L) ÷ Inventory (Bq).

For this evaluation, the analysis date for the results of detected value is set to March 11, 2011, and the date for the results of detection limit value is set to the actual analysis date.

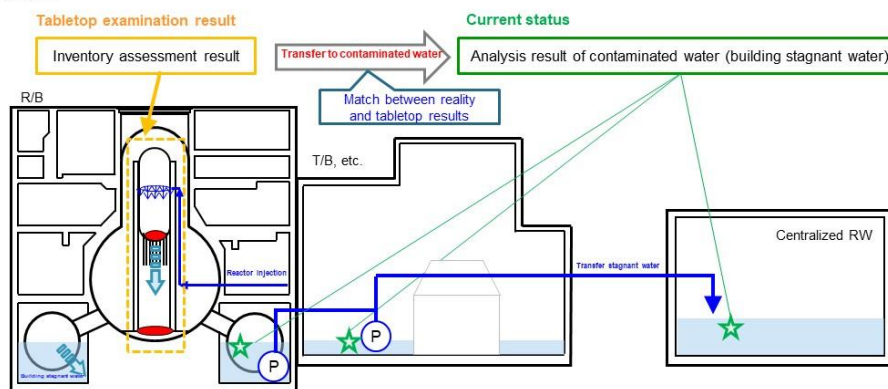

Figure 1.1.4-2 Image of the evaluation of transfer to contaminated water

Here, the reason why the relative ratio of the dose effect to the representative nuclides in the group is set at 1/100 or less, and for the transfer evaluation to contaminated water, it is set at 1/100 or less of the regulatory concentration limit, is that the dose effect of the nuclides is sufficiently small. For each, it was confirmed that in the case of the relative ratio, the dose effect of the nuclides to be excluded was 0.09% of the total, and in the assessment of transfer to contaminated water, the sum of the ratios to regulatory concentrations limits (evaluation) of the nuclides to be excluded was sufficiently small at $3.6E-02$ as compared with the sum of the ratios to regulatory concentrations limits (evaluation) $7.7E + 07$ of the nuclides to be advanced to Step 5.

In addition, since the sites to be assessed in this assessment are the stagnant water in buildings and the strontium removed water before treatment by ALPS, even if the total dose effect (assessed value) of the nuclides excluded in this step exceeds 1/100, the dose effect is considered to be negligibly small considering the subsequent treatment by ALPS.

2.4.2 Analysis results to be used for the evaluation of transfer to contaminated water

As shown in Table 1.1.4-4 and Figure 1.1.4-3, the analysis results to be used in the calculation of the transfer coefficient were classified and summarized into four types.

Since all contaminated water is collected in Centralized Rw (Process Main Building (PMB), High Temperature Incinerator Building (HTI)) and then treated with cesium adsorption system (SARRY/SARRY2), and this water finally becomes ALPS treated water. Therefore, the analysis results of Centralized Rw will be used in principle. However, only with the analysis results of Centralized Rw, it is impossible to obtain data on all radionuclides, and due to the reason that detection limits are high for building stagnant water because Cs concentration is high, available data on some nuclides is not enough. Therefore, as for those nuclides, analysis results of Units 1 to 4 building stagnant water, etc. and water before ALPS treatment will be used to complement the data.

Table 1.1.4-4 Classification of analysis results

No.	Classification of analyses	Details
[1]	Stagnant water in Unit 1 to 4 buildings	Analysis results of stagnant water in Unit 1 to 4 PCVs and buildings
[2]	Stagnant water in Centralized Rw building	Analysis results of water in Centralized Rw (PMB/HTI), at the inlet of SARRY, etc.
[3]	Cesium adsorption system - inlet of ALPS	Analysis results of water from the outlet of cesium adsorption system to the inlet of ALPS
[4]	Outlet of ALPS	Analysis results of water after ALPS treatment

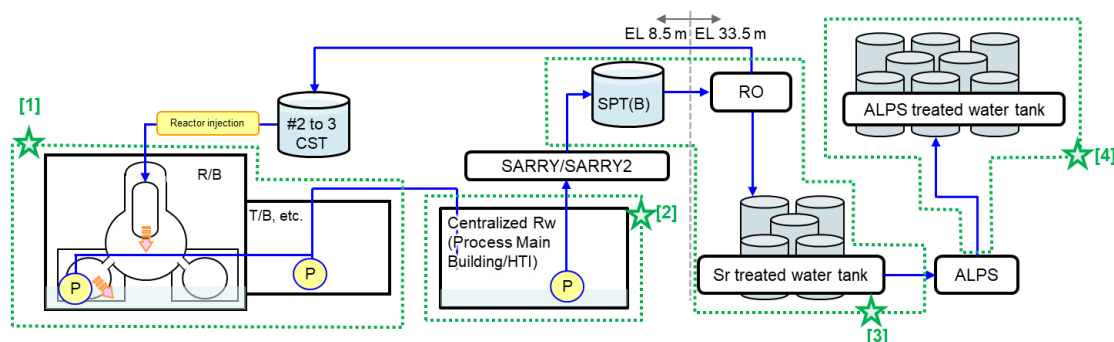
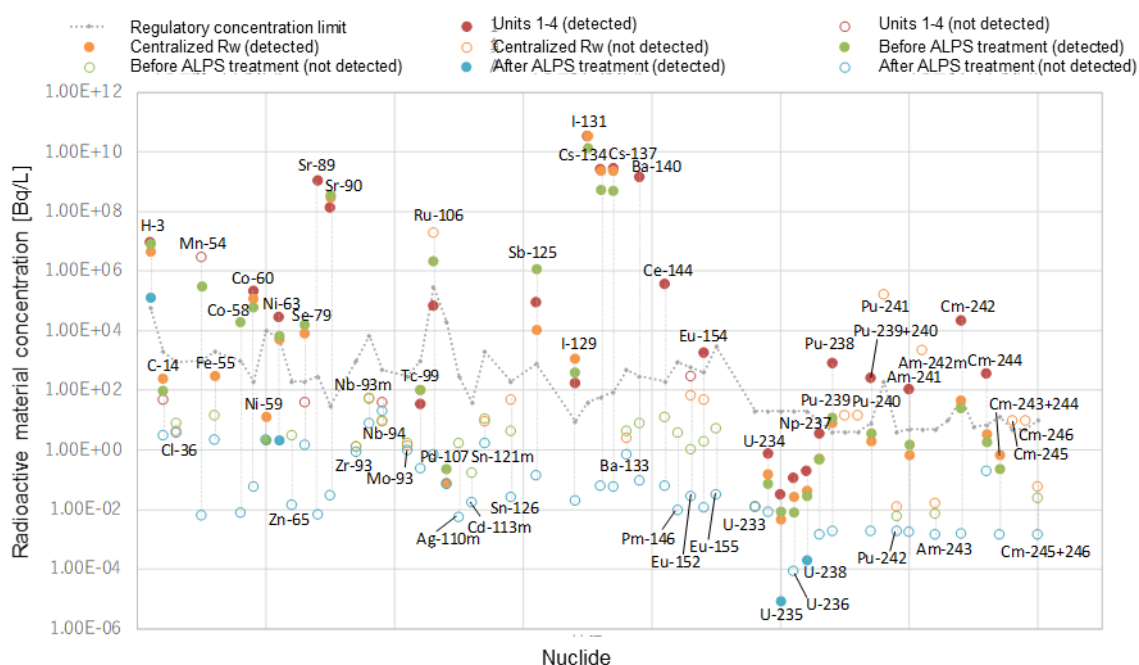

Figure 1.1.4-3 Classification of analysis results to be used for the evaluation of transfer

The data is classified according to the sampling locations shown in Table 1.1.4-4, and analysis results of the radionuclides which proceeded to Step 4 (including detected values of isotopes with a short half-life) is summarized in Figure 1.1.4-4. In Figure 1.1.4-4, the detected values for No.[1] to [3] in Table 1.1.4-4 are the maximum values which have been corrected decay until March 11, 2011, while non-detected values are minimum values of the analytical data. The values for No.[4] are minimum values of the analysis results. For nuclides that have never been detected in the past, the minimum values of the analytical data are used because although the detection limit indicates that there is a possibility of the presence at a concentration lower than that value, it guarantees that it cannot be higher than the concentration. Therefore, if the nuclide has never been detected in the past, even if it is assessed with the minimum detection limit among the analytical results, it is considered sufficiently conservative.

The figure shows the concentration ranges of individual radionuclides throughout the process from building stagnant water to ALPS treated water. It shows regulatory concentration limits as well to enable the comparison of the analysis results with regulatory limits.



*1: Sr -89 was detected at the inlet of the existing ALPS between 2013 and 2014, and Pm -146 was detected at the inlet of the high-performance ALPS in 2014. However, this is not subject to evaluation because it is a pseudo detection.

*2: For the FRAnDLi data on Pu-238, Am-241, and Cm-242, the analyzed values were simply decay corrected up to March 11, 2011. However, given that those nuclides are produced from parent nuclides, decay correction that takes into account the production of the parent nuclides was performed.

Figure 1.1.4-4 Summary of analysis results

Figure 1.1.4-4 is developed using the following data: FRAnDLi data published by JAEA that are available in September 2022 (including data published by TEPCO), analyses of 62 nuclides at the time of ALPS performance confirmation, etc. (FY 2013 to 2021), data of water before and after ALPS treatment which is available on the treated water portal, data of ALPS treated water, etc. tanks, etc. When using data on detection limits, only data which shows detection limit values is included in the aggregation, while data which only shows “N.D.” is excluded. Table 1.1.4-5 shows the number of pieces of analytical data for each radionuclide.

Table 1.1.4-5 Number of analyzed data (1/2)

Nuclide	[1] Units 1 - 4	[2] Centralized Rw	[3] Before ALPS treatment	[4] After ALPS treatment
	Number of data items (of which, number of items detected)	Number of data items (of which, number of items detected)	Number of data items (of which, number of items detected)	Number of data items (of which, number of items detected)
H-3	22(22)	28(28)	312(312)	483(483)
C-14	5(0)	15(1)	27(15)	339(338)
Cl-36	0(0)	10(0)	12(0)	3(0)
Mn-54	2(0)	0(0)	1195(290)	1893(14)
Fe-55	0(0)	1(1)	1(0)	3(0)
Co-58	0(0)	0(0)	27(5)	42(0)
Co-60	40(20)	37(25)	1569(1405)	2321(2177)
Ni-59	0(0)	3(1)	12(1)	3(0)
Ni-63	13(10)	17(15)	93(49)	55(1)
Zn-65	0(0)	0(0)	22(0)	42(0)
Se-79	10(0)	15(9)	47(12)	5(0)
Sr-89	4(3)	0(0)	66(17*1)	128(0)
Sr-90	41(40)	36(36)	845(834)	1773(768)
Zr-93	0(0)	1(0)	1(0)	3(0)
Nb-93m	0(0)	1(0)	1(0)	3(0)
Nb-94	36(0)	33(0)	68(0)	5(0)
Mo-93	0(0)	1(0)	1(0)	3(0)
Tc-99	5(2)	17(7)	247(222)	896(105)
Ru-106	6(1)	2(0)	1256(974)	2369(1425)
Pd-107	0(0)	1(1)	1(1)	1(0)
Ag-110m	0(0)	0(0)	22(0)	42(0)
Cd-113m	0(0)	0(0)	22(0)	42(0)
Sn-121m	0(0)	1(0)	1(0)	3(0)
Sn-126	0(0)	2(0)	34(0)	44(0)
Sb-125	27(9)	10(9)	1619(1606)	2369(1583)
I-129	22(4)	30(10)	450(381)	1833(1558)
I-131	4(0)	16(2)	43(22)	0(0)

*1: The results show that Sr-89 was detected at the inlet of existing ALPS during the period from 2013 to 2014, but it was excluded from the evaluation because it is a pseudo detection.

*2: Although it has not proceeded to Step 4, Te-123m (half-life of 119 days) was detected on September 9, 2019 at the outlet of added ALPS (B) at 1.1E - 01 Bq/L, which is less than 1/100 of the regulatory concentration limit (6.0E + 01 Bq/L) (The detection limit is 0.9E - 01 Bq/L).

Table 1.1.4-5 Number of analyzed data (2/2)

Nuclide	[1] Units 1 - 4	[2] Centralized Rw	[3] Before ALPS treatment	[4] After ALPS treatment
	Number of data items (of which, number of items detected)	Number of data items (of which, number of items detected)	Number of data items (of which, number of items detected)	Number of data items (of which, number of items detected)
Cs-134	190(190)	260(260)	1503(1262)	2377(360)
Cs-137	224(224)	296(296)	1746(1700)	2382(1505)
Ba-133	0(0)	1(0)	2(0)	6(0)
Ba-140	4(2)	0(0)	22(0)	42(0)
Ce-144	3(3)	0(0)	22(0)	42(0)
Pm-146	0(0)	0(0)	22(1* ¹)	42(0)
Eu-152	36(0)	36(0)	93(0)	44(0)
Eu-154	38(2)	36(0)	114(0)	47(0)
Eu-155	0(0)	0(0)	22(0)	42(0)
U-233	0(0)	3(0)	8(0)	3(0)
U-234	25(7)	19(11)	22(7)	3(0)
U-235	26(19)	19(14)	44(14)	6(3* ²)
U-236	20(7)	19(12)	22(8)	3(0)
U-238	31(26)	19(17)	44(20)	6(3* ²)
Np-237	9(9)	13(9)	16(7)	3(0)
Pu-238	38(17)	37(22)	73(16)	8(0)
Pu-239	0(0)	1(0)	0(0)	0(0)
Pu-240	0(0)	1(0)	0(0)	0(0)
Pu-239+240	38(12)	36(12)	73(10)	8(0)
Pu-241	0(0)	1(0)	0(0)	0(0)
Pu-242	0(0)	4(0)	8(0)	3(0)
Am-241	37(11)	37(6)	62(3)	7(0)
Am-242m	0(0)	1(0)	0(0)	0(0)
Am-243	0(0)	3(0)	8(0)	3(0)
Cm-242	7(2)	1(1)	2(1)	3(0)
Cm-244	37(7)	36(2)	61(6)	4(0)
Cm-243+244	0(0)	1(1)	1(1)	3(0)
Cm-245	0(0)	1(0)	0(0)	0(0)
Cm-246	0(0)	1(0)	0(0)	0(0)
Cm-245+246	0(0)	1(0)	1(0)	3(0)

*1: The results show that Pu-146 was detected at the inlet of high-performance ALPS in 2014, but it was excluded from the evaluation because it is a pseudo-detection.

*2: Natural uranium contained in ALPS treated water was detected (See Attachment-2)

2.4.3 Grouping of nuclides

2.4.3.1 Concept behind the grouping of nuclides

(1) Progeny nuclides in radioactive equilibrium

Among the nuclides which have proceeded to Step 4, nuclides that exist in the radioactive equilibrium are shown in Tables 1.1.4-6 and 1.1.4-7. The progeny nuclides shown in Table 1.1.4-6 have short half-lives, and in 12 years after the earthquake when ALPS treated water is set to be discharged into the sea, they exist only as nuclides produced by decay of parent nuclides. Therefore, in the evaluation of transfer to contaminated water, they are assumed to behave together with the parent nuclides. In the meantime, the release of the treated water is planned to be completed by the period of about 7 - 10 times the half-life of the progeny nuclide shown in Table 1.1.4-7, in which the half-life of the progeny nuclide is long, and the parent nuclide and the progeny nuclide are in the radioactive equilibrium. Based on this, in this evaluation, the parent nuclides and the progeny nuclides are assessed separately.

Table 1.1.4-6 Progeny nuclides that are in radioactive equilibrium and assumed to behave together with the parent

No.	Parent nuclide		Progeny nuclide	
	Nuclide	Half-life	Nuclide	Half-life
1	Sr-90	2.9E+01 [y]	Y-90	2.67 [d]
2	Ru-106	1.2E+00 [y]	Rh-106	30.07 [s]
3	Sn-121m	4.4E+01 [y]	Sn-121	1.13 [d]
4	Sn-126	2.3E+05 [y]	Sb-126 Sb-126m	12.35 [d] 19.15 [m]
5	Sb-125	2.8E+00 [y]	Te-125m	57.40 [d]
6	Cs-137	3.0E+01 [y]	Ba-137m	2.552 [m]
7	Ce-144	7.8E-01 [y]	Pr-144 Pr-144m	17.28 [m] 7.2 [m]
8	Pu-241	1.4E+01 [y]	U-237	6.752 [d]
9	Am-242m	1.4E+02 [y]	Np-238	2.117 [d]
10	Am-242m	1.4E+02 [y]	Am-242 Cm-242	16.02 [h] 162.9 [d]
11	Am-243	7.4E+03 [y]	Np-239	2.356 [d]

Table 1.1.4-7 Progeny nuclides that are in radioactive equilibrium but assumed to behave differently with the parent

No.	Parent nuclide		Progeny nuclide	
	Nuclide	Half-life	Nuclide	Half-life
1	Zr-93 Mo-93	1.6E+06 [y] 4.0E+03 [y]	Nb-93m	1.6E+01 [y]

(2) Nuclides produced from decay chains of uranium, neptunium, etc.
Among the nuclides which have proceeded to Step 4, the nuclides shown in red frames in Figure 1.1.4-5 are nuclides produced from decay chains of uranium, neptunium, etc. In the evaluation of transfer to contaminated water, those nuclides will be evaluated under assumption that they are behaving together with the parent nuclides (neptunium and uranium).

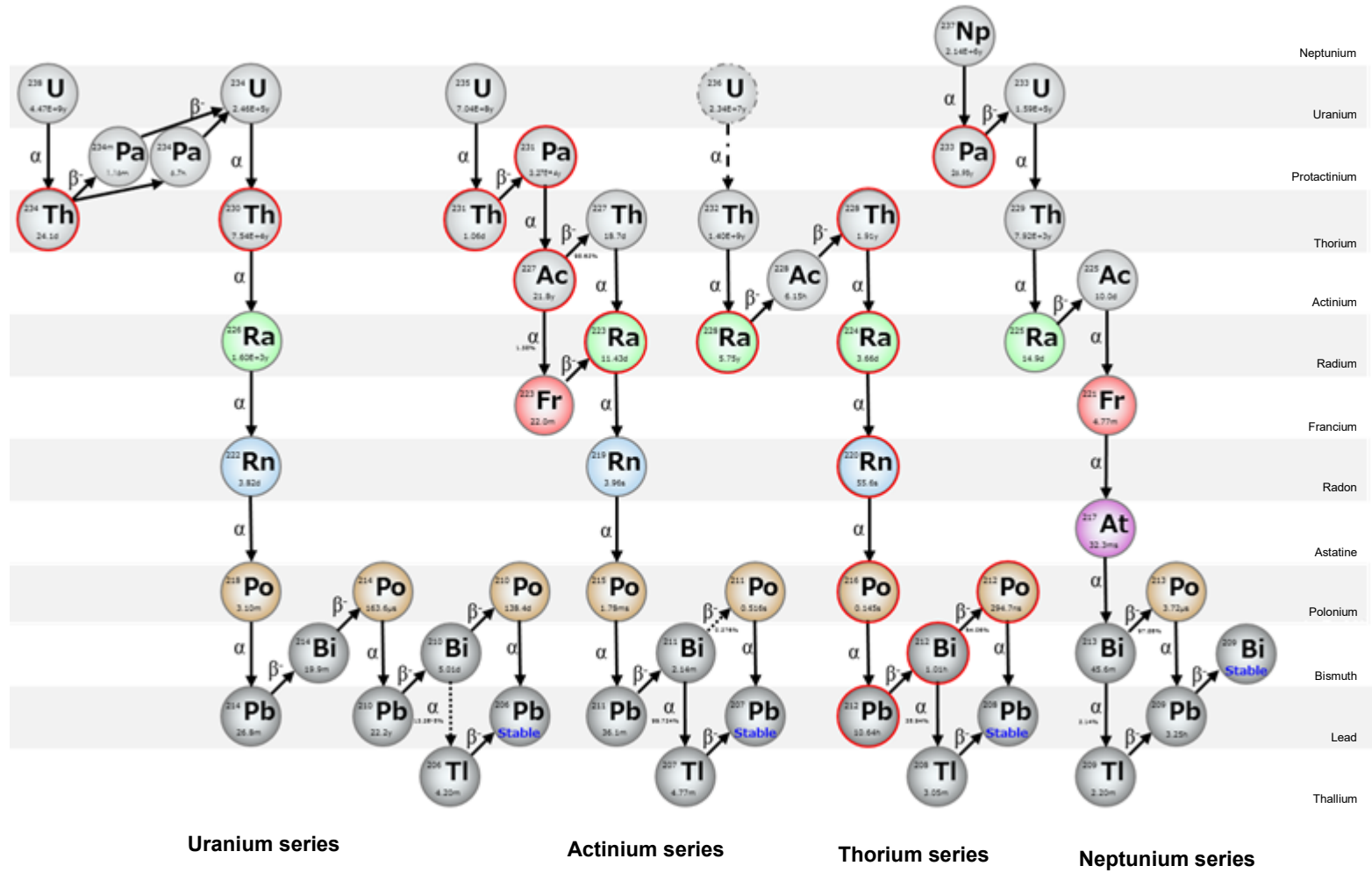

*: Compiled from the Nuclear Data Library (JENDL4.0).

Figure 1.1.4-5 Nuclides produced from decay chains of uranium, neptunium, etc.

(3) Isotope

Of the nuclides advanced to Step 4, the nuclides that exist as isotopes regardless of (1) and (2) are shown in Table 1.1.4-8.

Isotopes refer to nuclides with the same number of protons and a different number of neutrons. Since the chemical properties of materials are determined by the outermost electrons, the chemical properties of isotopes with the same number of electrons are almost the same. Therefore, in assessing the transfer to contaminated water, each isotope will be evaluated, assuming that they behave together.

Figure 1.1.4-8 Nuclides that are assessed to behave together because of their isotopes

No.	Element	Nuclide
1	Ni isotope	Ni-59,Ni-63
2	Nb isotope	Nb-93m,Nb-94
3	Ag isotope	Ag-108m,Ag-110m
4	Cd isotope	Cd-109,Cd-113m
5	Sn isotope	Sn-119m,Sn-121m,Sn-126
6	Cs isotope	Cs-134,Cs-135,Cs-137
7	Ce isotope	Ce-142,Ce-144
8	Pm isotope	Pm-146,Pm-147
9	Eu isotope	Eu-152,Eu-154,Eu-155
10	U isotope	U-232,U-233,U-234,U-235,U-236,U-238
11	Pu isotope	Pu-236,Pu-238,Pu-239,Pu-240,Pu-241,Pu-242
12	Am isotope	Am-241,Am-242m,Am-243
13	Cm isotope	Cm-243,Cm-244,Cm-245,Cm-246

(4) Nuclides showing similarities in characteristics underwater

In addition to nuclides in (1), (2) and (3), there are nuclides for which there is no available analytical data because analytical techniques have not been established as of 2022, because it is difficult to analyze individually, or for other reasons. These nuclides are evaluated as having characteristics similar to those of the nuclides with which the similarity has been confirmed after the similarity of chemical forms of nuclides in water (using the Eh-pH diagram*, etc.), ionic radii, adsorption characteristics in water treatment, etc. is confirmed.

*: The Eh-pH diagram shows the change of dissolved dominant chemical species and solid species in an aqueous solution given chemical composition with Eh and pH on the vertical and horizontal axes, respectively, as a function of Eh and pH. This time, it was used to confirm the similarity of the underwater chemical behavior of nuclides, and the actual dissolved form in ALPS treated water is not shown in this figure.

[1] Lanthanoids (Pm, Sm, Ho, Tm)

As lanthanoids to be removed by ALPS, Ce-141, Ce-144, Pm-146, Pm-148, Pm-148m, Eu-152, Eu-154, Eu-155, Gd-153, Tb-160 are analyzed and evaluated. However, they have never been detected in the analyses of water before ALPS treatment. Eu-152 and Eu-154 have not been detected in stagnant water in buildings in approximately 80 analyses performed in the past. On the other hand, Ce-144 and Eu-154 have been detected in samples of PCV stagnant water, which were collected during past internal investigations in Unit 2 and 3 PCVs.

This data on Ce-144 and Eu-154, which were detected in the PCVs, will be used for this evaluation of transfer to contaminated water for other lanthanoids, too. Therefore, the validity was checked with Eh-pH diagrams.

The verification has revealed that lanthanoids have a similarity in that they are stable trivalent cations at hydrogen-ion exponents (pH) of 6 to 8 in reactor injection water and building stagnant water (see Figure 1.1.4-6). Rare earth ions, including lanthanoids, generally have respective similar chemical properties and behaviors, and they are produced together in minerals, and it is difficult to separate them from each other during the refining process.* Therefore, assessing all lanthanoids as the same group is considered appropriate.

The transfer coefficients of Ce-144 and Eu-154, which belong to this group and have been analyzed, were evaluated in Section 2.4.4, which will be described later, and it was confirmed that they were almost the same value and that they actually behaved similarly in the 1F site.

*: Jiro Shiokawa, "Characteristics of Rare Earth Elements and Their Applications"

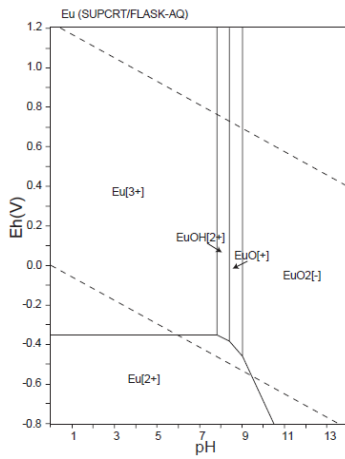

(1) Cerium (Ce)

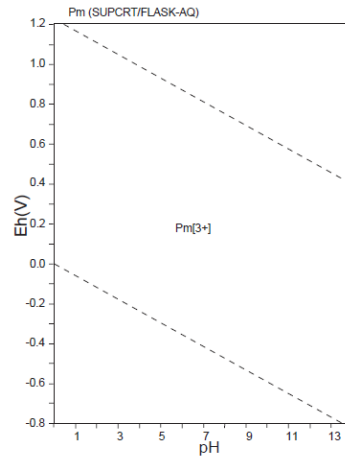

(2) Promethium (Pm)

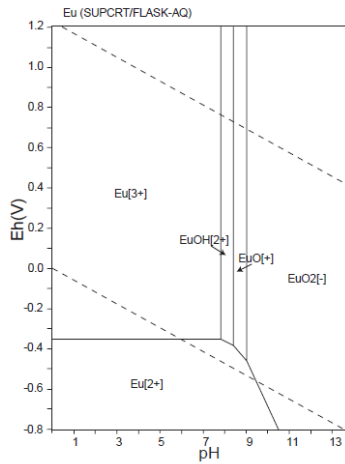

(3) Euronium (Eu)

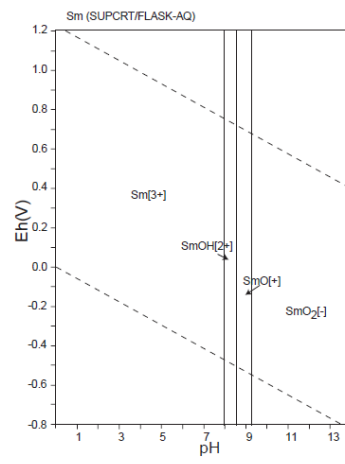

(4) Samarium (Sm)

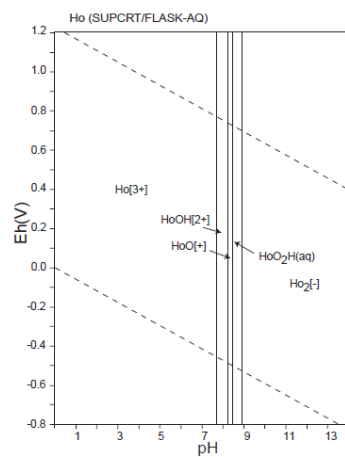

(5) Holmium (Ho)

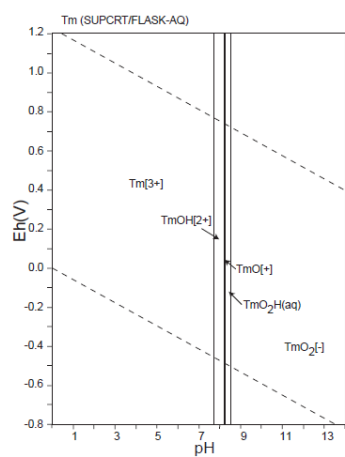

(6) Thulium (Tm)

Source: Takeno Naoto, Eh-pH Atlas - Intercomparison of the thermodynamics database, Geological Survey of Japan, research material No. 419, Geological Survey of Japan, National Institute of Advanced Industrial Science and Technology (2005)

Cited thermodynamics database:

- Johnson, J.W., Oelkers, E.H. and Helgeson, H.C., SUPCRT92 - A software package for calculating the standard molal thermodynamic properties of minerals, gases, aqueous species, and reactions from 1-bar to 5000-bar and 0°C to 1000°C. Computer and Geosciences 18, 899-947(1992)

Figure 1.1.4-6 Comparison of lanthanoids

1.1.4-19

[2] Platinum group (Ru, Pd, Pt)

As for the platinum group, Ru-103 (Rh-103m) and Ru-106 (Rh-106) have been analyzed as nuclides to be removed by ALPS, and Ru-106 (Rh-106) has been detected so far (both of the Rh are produced from the decay of Ru). Ru-106 has been selected as one of the seven main nuclides, which are representative nuclides for the performance check of ALPS. Additionally, Pd-107 was analyzed through the additional analysis shown in Attachment-2, and it was found to exist at a very low concentration in stagnant water in buildings and strontium removed water. Although Pt-193 has proceeded to Step 4, it has yet to be analyzed due to the lack of a measurement method that can measure the nuclide independently.

Therefore, when evaluating the transfer of Pt to contaminated water based on the analysis results of Ru-106 and Pd-107, the validity was checked with Eh-pH diagrams and solubility.

The verification has revealed that the platinum group exists in a solid state at hydrogen-ion exponents (pH) of 6 to 8 in reactor injection water and stagnant water in buildings (see Figure 1.1.4-7). Ru was found to exist as a single metal or solid of oxides, and Pd and Pt as solids of single metals. Their solubility in water was found to be very small: $2.0\text{E-}10$ mol/L^{*1} for Ru (single metal), $6.0\text{E-}10$ mol/L^{*1} for Ru (oxides), $1.0\text{E-}09$ mol/L^{*2} for Pd, $4.1\text{E-}10$ mol/L^{*1} for Pt. (The solubility of Ru (oxides) was calculated based on values mentioned in reference documents and from the solubility of anhydrous compounds, which is the most conservative solubility.) Given that the physical and chemical properties of platinum group elements are generally similar to one another and that they do not react with water and are not easily affected by acids and bases, it is appropriate to handle Pt-193 together with Ru-106 and Pd-107 as one group in evaluating the transfer to contaminated water.

The transfer coefficients of Ru-106 and Pd-107, which belong to this group and have been analyzed, were evaluated in Section 2.4.4, which will be described later, and it was confirmed that they were almost the same value and that they actually behaved similarly in the field of 1 F.

*1: Excerpt from “The International Platinum Group Metals Association, “Safe Use of Platinum Group Metals in the Workplace”, Chapter 2 PHYSICAL AND CHEMICAL PROPERTIES OF PLATINUM GROUP METALS (2017)”

*2: Excerpt from “Technical reliability of geological disposal of high-level radioactive waste in Japan - second summary of research and development on geological disposal -” (2000 Report)

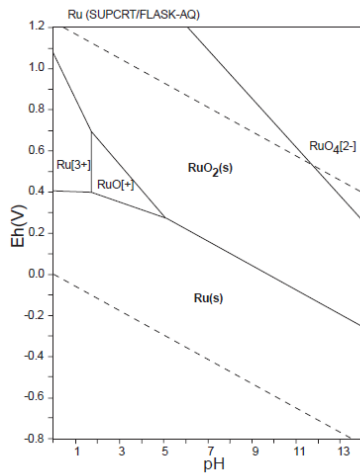

(1) Ruthenium (Ru)

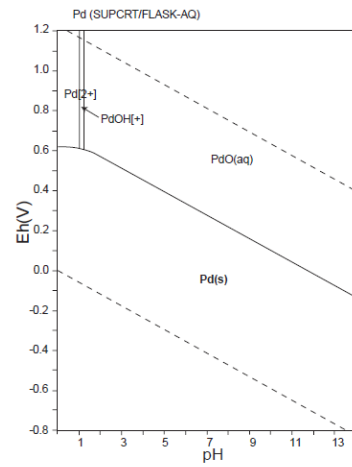

(2) Palladium (Pd)

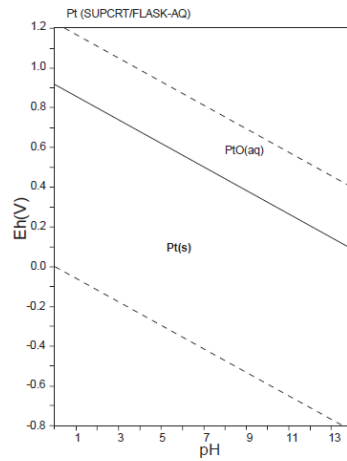

(3) Platinum (Pt)

Source: Takeno Naoto, Eh-pH Atlas - Intercomparison of the thermodynamics database, Geological Survey of Japan, research material No. 419, Geological Survey of Japan, National Institute of Advanced Industrial Science and Technology (2005)

Cited thermodynamics database:

- Johnson, J.W., Oelkers, E.H. and Helgeson, H.C., SUPCRT92 - A software package for calculating the standard molal thermodynamic properties of minerals, gases, aqueous species, and reactions from 1-bar to 5000-bar and 0°C to 1000°C. Computer and Geosciences 18, 899-947(1992)

Figure 1.1.4-7 Comparison among platinum group elements

[3] Thallium (Tl)

As for thallium, although Tl-204 has proceeded to Step 4, it has yet to be analyzed due to the lack of a measurement method that can measure the nuclide independently. However, this nuclide generally emits beta particles when disintegrating, and the energy is as high as about 760 keV. Considering that there is no deviation between the result of total beta analysis in ALPS treated water and the analysis of the major seven nuclides plus Tc-99 and C-14, it is reasonable to conclude that the nuclide does not exist in ALPS treated water at a significant concentration.

On the other hand, through the survey performed this time when evaluating transfer to contaminated water, thallium was found to have properties similar to alkali metal (Cs). Therefore, the validity will be explained with Eh-pH diagrams, ion radius, and adsorption properties during treatment.

Checking the Eh-pH diagrams has revealed that Tl, which is element 81, is a stable monovalent cation at hydrogen-ion exponents (pH) of 6 to 8 in reactor injection water and stagnant water in buildings (See Figure 1.1.4-8). In addition, the radius of Tl ion, which is 1.64 Å (6-coordinate) and 1.73 Å (8-coordinate), is in between the radius of alkali metal Cs ion, 1.81 Å (6-coordinate) and 1.81 Å (8-coordinate), and that of K ion, 1.51 Å (4-coordinate), 1.52 Å (6-coordinate), and 1.65 Å (8-coordinate); the selectivity of positive ions using zeolite has been evaluated as equal to that of alkali metal K ions^{*1}. It is also known^{*2} that Tl ions in waste liquid generated in mines are adsorbed to ferrocyanide compounds, activated carbon, titanate acid, and clay minerals in the same way as Cs ions, and a report^{*3} says they have the same level of adsorption property as Cs to soil.

Given the above, it is reasonable to evaluate thallium together with alkali metals as the same group while assuming that it will behave in the same way throughout the process from the transfer to contaminated water to water treatment.

*1: Nitta and Aomura, "Study on the Site Selectivity of Exchangeable Cation in Synthetic Zeolite A"

*2: Hariyin Xu, Yuanling Luo, et al. "Removal of thallium in water-wastewater", 2019-Water Research
Juan Liu, Xuwen Luo, et al. "Thallium pollution in China and removal technologies for waters",
2019-Environment International

L.G.Twidwell, C. Williams-Beam, "Potential Technologies for Removing Thallium from Mine and
Process Wastewater", Twidwell2002

Kobayashi, Yamamoto, and Akashi, "Prussian Blue as an Agent for Decontamination of ¹³⁷Cs in
Radiation Accidents"

*3: John E. Till, Helen A. Grogan, "Radiobiological Risk Assessment and Environmental Analysis"
Oxford University Press (2008).

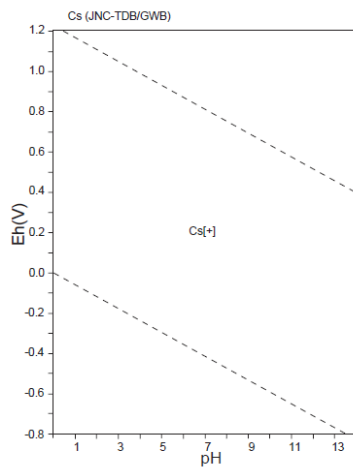

(1) Cesium (Cs)

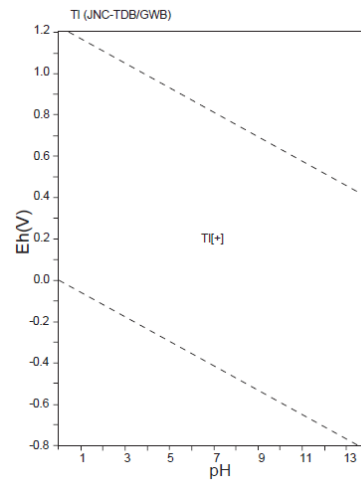

(2) Thallium (Tl)

Source: Takeno Naoto, Eh-pH Atlas - Intercomparison of the thermodynamics database, Geological Survey of Japan, research material No. 419, Geological Survey of Japan, National Institute of Advanced Industrial Science and Technology (2005)

Cited thermodynamics database:

- Yoshida Yasushi, Yui Miwa, JNC Thermodynamic Database Available for Geochemical Computational Codes, JNC TN8400 2003-005, Japan Nuclear Cycle Development Institute (2003)
- Yasushi Yoshida, Masahiro Shibata, Development of an Environment Using a Thermodynamic Database Prepared by OECD/NEA Part 2, JNC TN8400 2004-025, Japan Nuclear Cycle Development Institute (2005)

Figure 1.1.4-8 Comparison between thallium and cesium

[4] Californium (Cf)

As for californium, although Cf-250 has proceeded to Step 4, no analysis has been performed. However, this nuclide emits alpha particle when disintegrating. Considering that it was not detected in the APLS treated water in the gross α analysis, it is reasonable to conclude that the nuclide does not exist in ALPS treated water at a significant concentration.

On the other hand, based on the analytical results of Am and Cm, in assessing the transfer of Cf to contaminated water, the validity was checked by confirming the dissolution form in water and ionic radius, etc.

For californium, although it was impossible to check the validity with Eh-pH diagrams, it is considered a stable trivalent cation in a solution whose chemical behavior is very similar to that of trivalent transplutonium elements (Am, Cm)^{*1}. It has also been confirmed that the trivalent cations, Am, Cm, and Cf, have almost the same radii: 1.12 Å (6-coordinate), 1.11 Å (6-coordinate), and 1.09 Å (6-coordinate)^{*2} respectively.

Given the above, it is reasonable to evaluate the transfer of Cf to contaminated water together with Am and Cm as one group.

The transfer coefficients of Am-241, Cm-242, and Cm-244, which belong to this group and have been analyzed, were evaluated in Section 2.4.4, which will be described later, and found to be almost the same values. It has been confirmed that this group actually behaves similarly even in the field of 1F.

*1: Laster R.Morss, Norman M.Edelstein, Jean Fuger, "The Chemistry of The Actinide And Transactinide Elements_4thEd"

*2: R.D. Shannon, "Revised Effective Ionic Radii and Systematic Studies of Interatomic Distances in Halides and Chalcogenides"

2.4.3.2 Results of the grouping of nuclides

Tables 1.1.4-9 to 1.1.4-25 show the nuclide groups obtained as a result of the grouping in Step 4 based on the concept behind the grouping of nuclides which are shown in section 2.4.3.1. The nuclides in one group will be evaluated while assuming that they will behave in the same way throughout the process up to ALPS treatment. As explained in (2), the nuclides produced in the uranium, actinium, and thorium series are evaluated as a subgroup of uranium isotopes because they are considered to behave together with the original uranium. Additionally, except for the nuclides shown here, nuclides cannot be grouped, and the transfer to the contaminated water is assessed individually.

Nuclides that have been classified into a group will be compared with the representative nuclide that has the largest impact on the dose assessment among the nuclides in the group. If the relative ratio of a nuclide to the representative one (ratio of inventory/ regulatory concentration limit) is 1/100 or less, it will be excluded.

In addition, as explained in Attachment-3, there is uncertainty in the inventory evaluation of activation products (AP) on the conservative side. Therefore, if fission products (FP) and AP are mixed in the group, FP is selected as the representative nuclide for this evaluation. This prevents the evaluation of the relative ratio from becoming unconservative due to the uncertainty of the assessment.

Table 1.1.4-9 Group 1 (Ni isotopes)

Nuclide	Type	Half-life	Inventory (12 years later) [Bq]	Regulatory concentration limit [Bq/L]	Relative ratio to the representative nuclide	Evaluation result
Ni-59	AP	7.6E+04 [y]	7.3E+13	1.0E+04	0.0052	<i>Excluded</i>
Ni-63	AP	1.0E+02 [y]	8.5E+15	6.0E+03	1	Representative nuclide

Table 1.1.4-10 Group 2 (Sr-90 radioactive equilibrium)

Nuclide	Type	Half-life	Inventory (12 years later) [Bq]	Regulatory concentration limit [Bq/L]	Relative ratio to the representative nuclide	Evaluation result
Sr-90	FP	2.9E+01 [y]	3.9E+17	3.0E+01	1	Representative nuclide
Y-90	FP	2.67 [d]	3.9E+17	3.0E+02	0.10	

Table 1.1.4-11 Group 3 (Nb isotopes)

Nuclide	Type	Half-life	Inventory (12 years later) [Bq]	Regulatory concentration limit [Bq/L]	Relative ratio to the representative nuclide	Evaluation result
Nb-93m	FP	1.6E+01 [y]	6.3E+12	7.0E+03	1	Representative nuclide
Nb-94	AP	2.0E+04 [y]	9.0E+11	5.0E+02	2	

Table 1.1.4-12 Group 4 (Platinum group, Ru-106 radioactive equilibrium)

Nuclide	Type	Half-life	Inventory amount (12 years later) [Bq]	Regulatory concentration limit [Bq/L]	Relative ratio to the representative nuclide	Evaluation result
Ru-106	FP	1.0E+00 [y]	7.5E+14	1.0E+02	1	Representative nuclide
Rh-106	FP	30.07 [s]	7.6E+14	3.0E+05	0.00033	<i>Excluded</i>
Pd-107	FP	6.5E+06 [y]	6.1E+11	2.0E+04	0.0000041	<i>Excluded</i>
Pt-193	AP	5.0E+01 [y]	9.7E+12	3.0E+04	0.000043	<i>Excluded</i>

Table 1.1.4-13 Group 5 (Ag isotope)

Nuclide	Type	Half-life	Inventory (12 years later) [Bq]	Regulatory concentration limit [Bq/L]	Relative ratio to the representative nuclide	Evaluation result
Ag-108m	AP	4.4E+02 [y]	1.7E+11	4.0E+02	1.5	
Ag-110m	FP	249.8 [d]	8.8E+10	3.0E+02	1	Representative nuclide

Table 1.1.4-14 Group 6 (Cd isotope)

Nuclide	Type	Half-life	Inventory (12 years later) [Bq]	Regulatory concentration limit [Bq/L]	Relative ratio to the representative nuclide	Evaluation result
Cd-109	AP	1.3E+00[y]	3.6E+10	4.0E+02	0.000044	<i>Excluded</i>
Cd-113m	FP	1.4E+01 [y]	8.2E+13	4.0E+01	1	Representative nuclide

Table 1.1.4-15 Group 7 (Sn isotopes, Sn-126 radioactive equilibrium)

Nuclide	Type	Half-life	Inventory (12 years later) [Bq]	Regulatory concentration limit [Bq/L]	Relative ratio to the representative nuclide	Evaluation result
Sn-119m	AP	293.1 [d]	5.9E+10	2.0E+03	0.00065	<i>Excluded</i>
Sn-121	FP	1.13 [d]	7.1E+13	4.0E+03	0.39	
Sn-121m	FP	4.4E+01 [y]	9.1E+13	2.0E+03	1	Representative nuclide
Sn-126	FP	2.3E+05 [y]	1.6E+12	2.0E+02	0.18	
Sb-126	FP	12.35 [d]	2.3E+11	4.0E+02	0.012	
Sb-126m	FP	19.15 [m]	1.6E+12	2.0E+04	0.0018	<i>Excluded</i>

Table 1.1.4-16 Group 8 (Sb-125 radioactive equilibrium)

Nuclide	Type	Half-life	Inventory (12 years later) [Bq]	Regulatory concentration limit [Bq/L]	Relative ratio to the representative nuclide	Evaluation result
Sb-125	FP	2.8E+00 [y]	2.9E+15	8.0E+02	1	Representative nuclide
Te-125m	FP	57.40 [d]	1.1E+15	9.0E+02	0.33	

Table 1.1.4-17 Group 9 (Cs isotopes, Cs-137 radioactive equilibrium, Tl-204)

Nuclide	Type	Half-life	Inventory (12 years later) [Bq]	Regulatory concentration limit [Bq/L]	Relative ratio to the representative nuclide	Evaluation result
Cs-134	FP+AP	2.1E+00 [y]	2.5E+16	6.0E+01	0.070	
Cs-135	FP	2.3E+06 [y]	3.5E+12	6.0E+02	0.00000099	<i>Excluded</i>
Cs-137	FP	3.0E+01 [y]	5.3E+17	9.0E+01	1	Representative nuclide
Ba-137m	FP	2.552 [m]	5.0E+17	8.0E+05	0.00011	<i>Excluded</i>
Tl-204	AP	3.8E+00 [y]	1.4E+13	7.0E+02	0.0000035	<i>Excluded</i>

Table 1.1.4-18 Group 10 (Lanthanoids)

Nuclide	Type	Half-life	Inventory (12 years later) [Bq]	Regulatory concentration limit [Bq/L]	Relative ratio to the representative nuclide	Evaluation result
Ce-142	FP	5.0E+16 [y]	1.8E+08	7.0E-01	0.0000083	<i>Excluded</i>
Ce-144	FP	284.91 [d]	1.7E+14	2.0E+02	0.027	
Pr-144	FP	17.28 [m]	1.7E+14	2.0E+04	0.00027	<i>Excluded</i>
Pr-144m	FP	7.2 [m]	2.5E+12	4.0E+04	0.000002	<i>Excluded</i>
Pm-146	FP	5.5E+00 [y]	3.6E+12	9.0E+02	0.00013	<i>Excluded</i>
Pm-147	FP	2.6E+00 [y]	5.6E+16	3.0E+03	0.59	
Sm-151	FP	9.0E+01 [y]	2.2E+15	8.0E+03	0.0085	*
Eu-152	FP	1.4E+01 [y]	9.0E+12	6.0E+02	0.00048	<i>Excluded</i>
Eu-154	FP	8.6E+00 [y]	1.3E+16	4.0E+02	1	Representative nuclide
Eu-155	FP	4.8E+00 [y]	3.8E+15	3.0E+03	0.04	
Ho-166m	AP	1.2E+03 [y]	2.6E+10	4.0E+02	0.000002	<i>Excluded</i>
Tm-171	AP	1.9E+00 [y]	5.3E+12	7.0E+03	0.000024	<i>Excluded</i>

*: Not excluded because it has a longer half-life than the representative nuclide Eu-154 and the relative ratio exceeds 0.01 during the discharge period.

Table 1.1.4-19 Group 11 (U isotopes)

Nuclide	Type	Half-life	Inventory (12 years later) [Bq]	Regulatory concentration limit [Bq/L]	Relative ratio to the representative nuclide	Evaluation result
U-232	FP	6.9E+02 [y]	1.2E+11	3.0E+00	0.06	
U-233	FP	1.6E+05 [y]	4.0E+08	2.0E+01	0.00003	<i>Excluded</i>
U-234	FP	2.5E+05 [y]	1.4E+13	2.0E+01	1	Representative nuclide
U-235	FP	7.0E+08 [y]	3.7E+11	2.0E+01	0.027	
U-236	FP	2.3E+07 [y]	2.0E+12	2.0E+01	0.15	
U-238	FP	4.5E+09 [y]	3.0E+12	2.0E+01	0.22	

Table 1.1.4-20 Group 11-1 (Uranium decay series)

Nuclide	Type	Half-life	Inventory (12 years later) [Bq]	Regulatory concentration limit [Bq/L]	Relative ratio to the representative nuclide	Evaluation result
U-238	FP	4.5E+09 [y]	3.0E+12	2.0E+01	0.22	
Th-234	FP	24.1 [d]	3.0E+12	2.0E+02	0.022	
U-234	FP	2.5E+05 [y]	1.4E+13	2.0E+01	1	
Th-230	FP+AP	7.5E+04 [y]	2.4E+09	4.0E+00	0.00089	<i>Excluded</i>

Table 1.1.4-21 Group 11-2 (Actinium decay series)

Nuclide	Type	Half-life	Inventory (12 years later) [Bq]	Regulatory concentration limit [Bq/L]	Relative ratio to the representative nuclide	Evaluation result
U-235	FP	7.0E+08 [y]	3.7E+11	2.0E+01	0.027	
Th-231	FP	1.063 [d]	3.7E+11	2.0E+03	0.00027	<i>Excluded</i>
Pa-231	FP	3.3E+04 [y]	2.6E+08	1.0E+00	0.00038	<i>Excluded</i>
Ac-227	FP	2.2E+01 [y]	7.2E+07	8.0E-01	0.00013	<i>Excluded</i>
Ra-223	FP	11.43 [d]	7.2E+07	5.0E+00	0.000021	<i>Excluded</i>

Table 1.1.4-22 Group 11-3 (Thorium decay series)

Nuclide	Type	Half-life	Inventory (12 years later) [Bq]	Regulatory concentration limit [Bq/L]	Relative ratio to the representative nuclide	Evaluation result
U-236	FP	2.3E+07 [y]	2.0E+12	2.0E+01	0.15	
Ra-228	AP	5.8E+00 [y]	1.8E+07	7.0E-01	0.000038	<i>Excluded</i>
Th-228	FP	1.9E+00 [y]	1.2E+11	9.0E+00	0.019	
Ra-224	FP	3.66 [d]	1.2E+11	9.0E+00	0.019	
Rn-220	FP	55.6 [s]	1.2E+11	4.0E+03	0.000044	<i>Excluded</i>
Po-216	FP	0.145 [s]	1.2E+11	4.0E+03	0.000044	<i>Excluded</i>
Pb-212	FP	10.64 [h]	1.2E+11	1.0E+02	0.0017	<i>Excluded</i>
Bi-212	FP	1.01 [h]	1.2E+11	3.0E+03	0.000058	<i>Excluded</i>
Po-212	FP	294.7 [ns]	7.6E+10	4.0E+03	0.000028	<i>Excluded</i>

Table 1.1.4-23 Group 12 (Neptunium decay series)

Nuclide	Type	Half-life	Inventory (12 years later) [Bq]	Regulatory concentration limit [Bq/L]	Relative ratio to the representative nuclide	Evaluation result
Np-237	FP	2.1E+06 [y]	1.7E+12	9.0E+00	1	
Pa-233	FP	26.98 [d]	1.7E+12	9.0E+02	0.01	

Table 1.1.4-24 Group 13 (Pu isotope, Pu-241 radioactive equilibrium)

Nuclide	Type	Half-life	Inventory (12 years later) [Bq]	Regulatory concentration limit [Bq/L]	Relative ratio to the representative nuclide	Evaluation result
Pu-236	FP	2.9E+00 [y]	1.1E+11	1.0E+01	0.0000027	<i>Excluded</i>
Pu-238	FP	8.8E+01 [y]	1.6E+16	4.0E+00	1	Representative nuclide
Pu-239	FP	2.4E+04 [y]	2.6E+15	4.0E+00	0.17	
Pu-240	FP	6.6E+03 [y]	3.3E+15	4.0E+00	0.21	
Pu-241	FP	1.4E+01 [y]	4.3E+17	2.0E+02	0.55	
Pu-242	FP	3.7E+05 [y]	1.1E+13	4.0E+00	0.00071	<i>Excluded</i>
U-237	FP	6.752 [d]	1.1E+13	1.0E+03	0.0000027	<i>Excluded</i>

Table 1.1.4-25 Group 14 (Am isotope, Cm isotope, Am 242m/Am-243 radioactive equilibrium, Cf-250)

Nuclide	Type	Half-life	Inventory (12 years later) [Bq]	Regulatory concentration limit [Bq/L]	Relative ratio to the representative nuclide	Evaluation result
Am-241	FP	4.3E+02 [y]	1.3E+16	5.0E+00	1	Representative nuclide
Am-242	FP	16.02 [h]	9.0E+13	3.0E+03	0.000011	<i>Excluded</i>
Am-242m	FP	1.4E+02 [y]	9.0E+13	5.0E+00	0.0069	<i>Excluded</i>
Am-243	FP	7.4E+03 [y]	8.5E+13	5.0E+00	0.0065	<i>Excluded</i>
Np-238	FP	2.117 [d]	4.5E+11	9.0E+02	0.00000019	<i>Excluded</i>
Np-239	FP	2.356 [d]	8.5E+13	1.0E+03	0.000032	<i>Excluded</i>
Cm-242	FP	162.9 [d]	7.4E+13	6.0E+01	0.00047	<i>Excluded</i>
Cm-243	FP	2.9E+01 [y]	7.5E+13	6.0E+00	0.0048	<i>Excluded</i>
Cm-244	FP	1.8E+01 [y]	6.5E+15	7.0E+00	0.35	
Cm-245	FP	8.4E+03 [y]	1.1E+12	5.0E+00	0.000083	<i>Excluded</i>
Cm-246	FP	4.8E+03 [y]	1.8E+12	5.0E+00	0.000013	<i>Excluded</i>
Cf-250	FP	1.3E+01 [y]	7.1E+07	5.0E+00	0.0000000054	<i>Excluded</i>

2.4.4 Evaluation of transfer coefficients

For the group set in Section 2.4.3 and individual nuclides that could not be grouped, transfer coefficients are calculated from the analysis results (including isotope detected values) shown in Figure 1.1.4-4 using the inventory evaluation results from March 11, 2011. As described previously, the maximum value among the results of the centralized Rw is generally used for the evaluation of transfer coefficients, and transfer coefficients rounded up to a higher order of magnitude are used for the evaluation to account for the variation in the analytical values. The results of evaluating the transfer coefficient are shown in Fig. 1.1.4-9.

In addition, as explained in Attachment-3, there is uncertainty in the inventory evaluation of AP on the conservative side. Therefore, when FP and AP coexist in a group and the transfer coefficient of AP is low, FP should be selected as the representative nuclide for this evaluation. This prevents the evaluation of the transfer coefficient from becoming unconservative due to the uncertainty of the evaluation.

First, the results of groups 1 - 4 were shown, and it was confirmed that these tended to be similar in each group. In addition, though the result of barium, which is also an alkaline earth metal, was shown next to group 2 (Sr), it was confirmed that Ba-140 of FP nuclide showed the same transfer coefficient as Sr-89 and Sr-90 of the same FP nuclide.

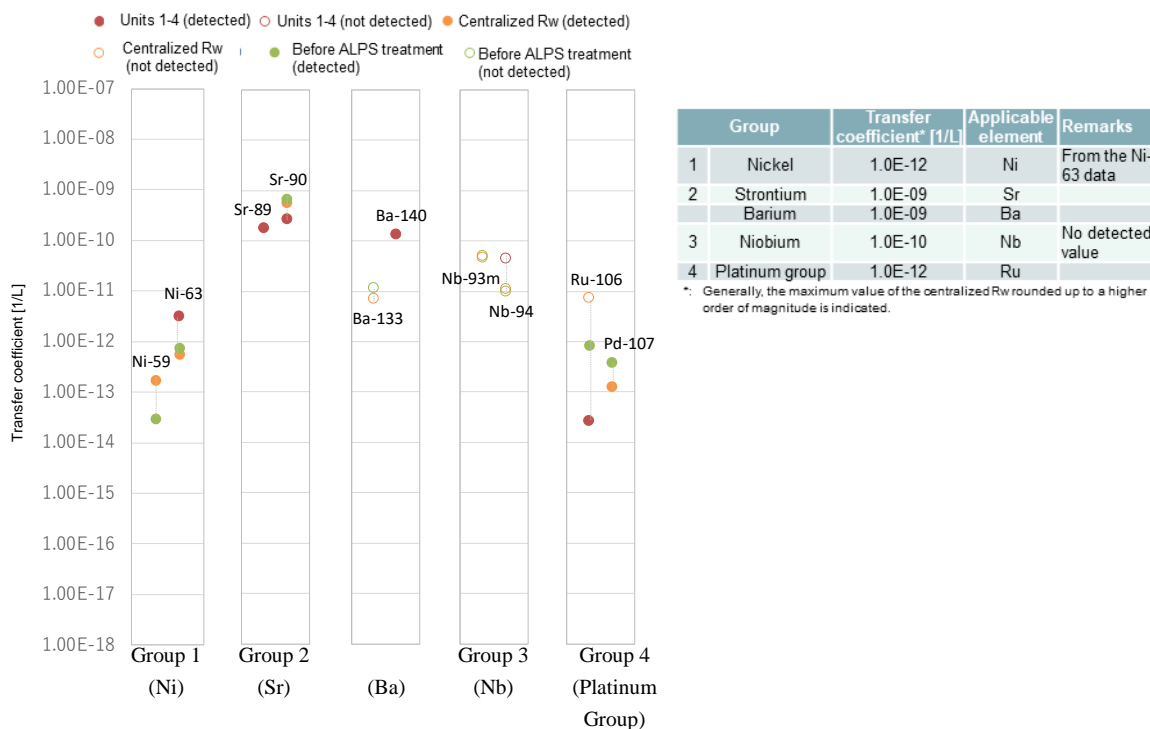

Figure 1.1.4-9 Transfer coefficients (1/4)

The results of groups 5 - 9 are shown below.

Since silver, cadmium, and tin have not been detected before, the transfer coefficient is calculated from the lower detection limit. As for antimony, the transfer coefficient is calculated using the same value because the number of detected data of the centralized Rw is 9, compared with 1606 before treatment by ALPS, and the activity concentration before treatment by ALPS is higher. It was confirmed that cesium showed almost the same behavior in its isotopes, Cs-134 and Cs-137.

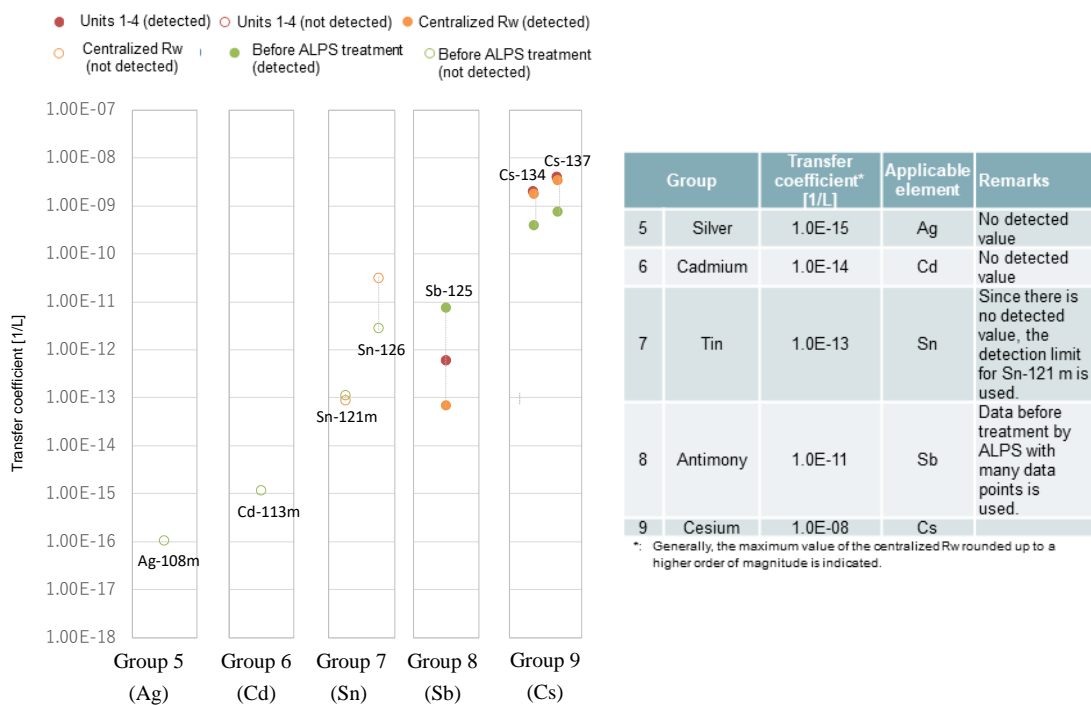
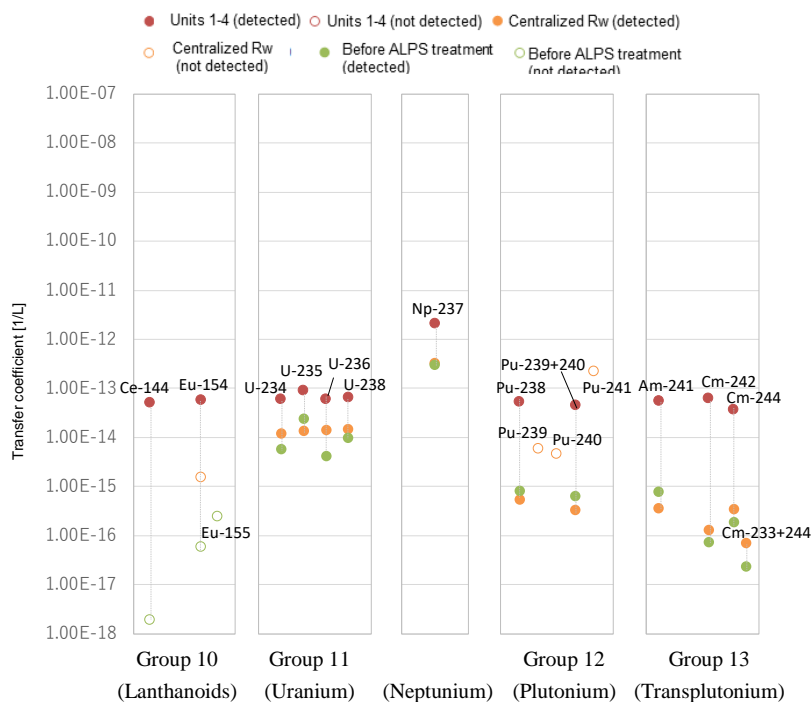

Figure 1.1.4-9 Transfer coefficients (2/4)

The results of groups 10 - 13 are shown below.

As for lanthanoids, it was confirmed that Ce and Eu showed almost the same transfer behavior as in the documents. In addition, uranium, plutonium, americium, and curium were also confirmed to behave almost the same in isotope and group, and the result of neptunium was also described. It was confirmed that neptunium was easier to transfer to water than other actinoids.

Lanthanoids and actinoids showed almost the same transfer behavior in the stagnant water in the buildings of Units 1 to 4 except for neptunium, but slightly different behavior in each group after the centralized Rw. Based on these trends, the transfer coefficient is calculated.



Group	Transfer coefficient* [1/L]	Applicable element	Remarks
10	1.0E-13	Ce, Pm, Sm, Eu	Since there is no detected value after the centralized Rw, the detection values of Ce-144 and Eu-154 detected in the past (in the PCV of Units 2 and 3) are used.
11	1.0E-13	U	
	1.0E-11	Np	
12	1.0E-15	Pu	
13	1.0E-15	Am, Cm	

*: Generally, the maximum value of the centralized Rw rounded up to a higher order of magnitude is indicated.

Figure 1.1.4-9 Transfer coefficients (3/4)

Finally, nuclides that were not grouped but were assessed individually are indicated. Relatively high transfer coefficients were confirmed for tritium, selenium, carbon, and halogen iodine, which are nonmetals. Since there was no detected value for chlorine in the past, the transfer coefficient was calculated from the detection limit. For transition metals, data before treatment by ALPS with detected values for manganese were used, and iron reflected the results detected by the present additional analysis. In addition to confirming that cobalt had almost the same behavior in isotopes, the transfer coefficients of zinc, zirconium, and molybdenum were calculated from the lower detection limits because there were no detected values, and the transfer coefficients of technetium were calculated using the detected values of the centralized Rw.



Figure 1.1.4-9 Transfer coefficients (4/4)

2.4.5 Results of the evaluation of transfer to contaminated water

As a result of the evaluation of transfer performed with the transfer coefficients obtained in section 2.4.4, the number of nuclides that are to proceed to Step 5 is 36 nuclides, while 57 nuclides are to be excluded.

Table 1.1.4-26 Nuclides to proceed to Step 5 (36 nuclides)

<i>No.</i>	Nuclide	<i>No.</i>	Nuclide	<i>No.</i>	Nuclide	<i>No.</i>	Nuclide	<i>No.</i>	Nuclide
1	H-3	27	Sr-90	60	Sb-125	93	Sm-151	189	Pu-240
3	C-14	29	Y-90	67	Te-125m	96	Eu-154	190	Pu-241
7	Cl-36	33	Nb-93m	70	I-129	97	Eu-155	194	Am-241
16	Mn-54	34	Nb-94	71	Cs-134	174	U-234	201	Cm-244
17	Fe-55	35	Mo-93	73	Cs-137	178	U-238		
18	Co-60	38	Tc-99	74	Ba-133	182	Np-237		
20	Ni-63	39	Ru-106	80	Ce-144	187	Pu-238		
23	Se-79	51	Cd-113m	87	Pm-147	188	Pu-239		

2.5 Step 5

In Step 5, "Does the ratio of the concentration of each radionuclide to the regulatory concentration limit is less than 1/100 on the analysis results as contaminated water in the past?," the nuclides that have proceeded to this step are checked if they have been detected significantly (1/100 or more of the regulatory concentration limit) with detection limit set to 1/100 of the regulatory concentration limit in past analyses of contaminated water. Then, nuclides which have not been detected are classified as nuclides to be monitored, and the other nuclides except tritium that cannot be removed by ALPS are classified as nuclides to be measured and assessed.

The rationale behind this step is as follows. In the evaluation up to step 4 is conservative, and nuclides that have been confirmed to be less than 1/100 of the regulatory concentration limit in the analysis of contaminated water in the past are considered to be very unlikely to be included in ALPS treated water. Therefore, it is considered very conservative to select them as the target nuclides for measurement and assessment to be confirmed each time they are released. Even so, given that they have proceeded to Step 5 (with relatively large inventories) and that their half-lives are long, the situation may change depending on the progress of decommissioning even though they have not been found to exist at significant concentrations so far. Therefore, those nuclides are classified as nuclides that are not to be measured at each discharge but to be monitored constantly to check for significant presence in contaminated water. As analytical data will be collected through periodical checking of nuclides to be measured and assessed, which will be described later, the concerned will be reviewed as necessary in accordance with the selection flow based on the obtained data.

As the analysis data will be collected for the nuclides to be monitored, the nuclides will be re-evaluated in accordance with the selection flow based on the data.

Table 1.1.4-27 shows the six nuclides to be monitored which have been selected this time.

Table 1.1.4-27 Nuclides to be monitored

Nuclide	Number of analyses (Numbers in parentheses are number of detections)			Analysis result [Bq/L]	Regulatory concentration limit [Bq/L]
	(1) Units 1 to 4	(2) Centralized Rw	(3) Before treatment by ALPS		
Cl-36	0(0)	10(0)	12(0)	< 4.3E+00	9.0E+02
Nb-93m	0(0)	1(0)	1(0)	< 5.2E+01	7.0E+03
Nb-94	36(0)	33(0)	68(0)	< 6.8E-01	5.0E+02
Mo-93	0(0)	1(0)	1(0)	< 1.4E+00	3.0E+02
Cd-113m	0(0)	0(0)	22(0)	< 1.7E-01	4.0E+01
Ba-133	0(0)	1(0)	1(0)	< 2.6E+00	5.0E+02

Although the numbers of analyses for three of the six nuclides are small, given that the water used for the injection to reactors is RO plain water and that the quality standard specified by the Chapter III, Part 1 of Implementation Plan for the water to be used for injection, whose conductivity is 40 mS/m or less at 25°C (if the conductivity exceeds 40 mS/m, the chloride ion concentration of 100 ppm or less is confirmed), has been satisfied constantly, the environment in reactors and transition status of radionuclides to the contaminated water are unlikely to change. Therefore, this selection is reasonably considered as appropriate.

Other nuclides with a small number of analyses are Ni-59, Sn-121m, Zr-93 and Nb-93m. In Ni-59

and Sn-121 m, there are isotopes (Ni-63, Sn-126) that are to be removed by ALPS. Therefore, the necessity of measurement is determined based on their measurement results and relative ratios (ratio of inventory/ regulatory concentration limit) described in section 2.4.3.2. In addition, since Zr-93 has an established measurement method (ICP-MS) and a long half-life ($1.6E + 06$ years), it was possible to measure up to about 1/1000 of the regulatory concentration limit in 2 samples of stagnant water in buildings and strontium removed water, and 3 samples of ALPS treated water. The result was that it was not detected. With this, it is considered that it rarely transfers to the contaminated water, and it was determined that further measurement was not required.

Although Eu-155 has not been detected above 1/100 of the regulatory concentration limit, they are set as the nuclides that are not monitored but are set as nuclides to be measured and evaluated. The concept of this is described in the table below.

Table 1.1.4-28 Nuclides not subject to monitoring, though the analysis confirmed that they were below 1/100 of the regulatory concentration limit.

Nuclide	Step 4			Regulatory concentration limit [Bq/L]	Reason for selection
	Sampling point	Sampling date	Measured value [Bq/L]		
Eu-155	ALPS inlet	Aug 2, 2019	<5.3E+00	3.0E+03	Eu-155 was measured only at the ALPS inlet, and although it was not detected at this place, the isotope Eu-154 was confirmed in the PCV of Unit 3, and its concentration was $1.9 E + 03$ Bq/L. At that time, Eu-155 was not measured, but the concentration was assessed $5.7 E + 02$ Bq/L from the result of Eu-154 (0.3 times Eu-154*), exceeding 1/100 of the regulatory concentration limit. For this reason, it was selected.

*: Calculated based on the inventory ratio 12 years after the earthquake

On the other hand, Step 5 confirms the actual condition, unlike Step 4. Therefore, assuming the future transition to the downstream side, the target to be checked was set conservatively up to the stagnant water in buildings of Units 1 to 4. For this reason, there are nuclides to be measured and evaluated, although they have not been detected at 1/100 or more of the regulatory concentration limit downstream from the centralized Rw used to assess transfer to contaminated water in Step 4, the conditions are as shown in Table 1.1.4-29.

Table 1.1.4-29 Nuclides that were not detected at 1/100 or more of the regulatory concentration limit downstream from the centralized Rw but were set as the nuclides to be measured and evaluated.

Nuclide	Step 4			Step 5			Regulatory concentration limit [Bq/L]	Remarks
	Sampling point	Sampling date	Measured value [Bq/L]	Sampling point	Sampling date	Measured value [Bq/L]		
U-234	PMB	Nov 2, 2021	1.6E-01	Units 1 to 4	Oct 22, 2015	7.7E-01	2.0E+01	The sampling point of Step 5 is inside the PCV of Unit 3.
U-238	PMB	Dec 21, 2018	4.5E-02	Units 1 to 4	Jul 8, 2021	2.0E-01	2.0E+01	The sampling location of Step 5 is the MSIV room of Unit 3.

2.6 Results of the selection

Table 1.1.4-30 shows the 29 nuclides to be measured and assessed that have been selected in accordance with the flow shown in Figure 1.1.4-1. The table also shows quantification methods that are currently planned for these nuclides. When the discharge standard (the sum of ratio to the regulatory concentration limits of radionuclides other than tritium is less than 1) is confirmed in the measurement and confirmation facility, the ratio to the regulatory concentration limit of α nuclides is calculated by dividing the gross α value by the lowest regulatory concentration limit (4 Bq/L) among the selected α nuclides. In addition to the 29 nuclides shown in the table below, H-3 concentration will also be measured before discharge into the sea in order to set dilution ratio.

Table 1.1.4-30 Nuclides to be measured and assessed and quantification methods

No.	Nuclide	Quantification method	No.	Nuclide	Quantification method
1	C-14	After chemical separation, measure β -rays	16	Ce-144	γ -ray nuclide analysis
2	Mn-54	γ -ray nuclide analysis	17	Pm-147	Assessed from the activity concentration of representative nuclide (Eu-154)
3	Fe-55	After chemical separation, X-ray measurement	18	Sm-151	
4	Co-60	γ -ray nuclide analysis	19	Eu-154	γ -ray nuclide analysis
5	Ni-63	After chemical separation, measure β -rays	20	Eu-155	γ -ray nuclide analysis
6	Se-79	After chemical separation, measure β -rays	21	U-234	Assessed as included in the gross α radioactivity
7	Sr-90	After chemical separation, measure β -rays	22	U-238	
8	Y-90	Radioactive equilibrium with Sr-90	23	Np-237	
9	Tc-99	ICP-MS	24	Pu-238	
10	Ru-106	γ -ray nuclide analysis	25	Pu-239	
11	Sb-125	γ -ray nuclide analysis	26	Pu-240	
12	Te-125m	Radioactive equilibrium with Sb-125	27	Pu-241	Assessed from the activity concentration of representative nuclide (Pu-238)
13	I-129	ICP-MS			
14	Cs-134	γ -ray nuclide analysis	28	Am-241	Assessed as included in the gross α radioactivity
15	Cs-137	γ -ray nuclide analysis	29	Cm-244	

3. Periodical checking of nuclides to be measured and assessed

The nuclides to be measured and assessed which were identified in section 2 were selected based on the results of past analyses. However, the situation may change depending on the progress of future decommissioning work. Therefore, the following checking will be performed to make sure that nuclides other than the selected nuclides to be measured and assessed (hereinafter referred to as “other nuclides”) do not exist at significant concentrations. If other nuclides are found to exist at significant concentrations through the checking, the nuclides to be measured and assessed will be reassessed. As the survey and analysis described in Section 3.3 below are performed at least once a year, the necessity of reevaluation is reviewed at this frequency. The decay of radionuclides will also be taken into account in the reevaluation based on the selection flow.

3.1 Checking before each discharge

When ensuring the discharge criteria before discharge into the sea, the measurement shown in table below will be performed to make sure that other nuclides do not exist at significant concentrations.

Table 1.1.4-31 Confirmation method at each discharge

Nuclide type	Confirmation method
α nuclides	Check the gross α value to make sure that the value is below the lower limit of detection, which is 1/100 order or less of the regulatory concentration limit (4 Bq/L).
β nuclides	Check the gross β value to make sure that nuclides other than the nuclides to be measured and assessed do not exist at significant concentrations.
γ nuclides	Check with gamma spectrum of Ge semiconductor detector for significant peaks derived from contaminated water aside from the nuclides to be measured and assessed.

3.2 Checking trend in the contaminated water

The concentrations of radionuclides* in contaminated water after the Centralized Rw which have been checked at a frequency of once a month or more while facilities are in operation will be inspected to make sure that they are below the concentrations recorded in the past, and thus ensure that the transfer status of radionuclides to contaminated water will not change.

*: Concentrations of Cs-134, Cs-137, Sr-90, gross β , gross α , and H-3 were checked in the centralized Rw as of November 2022. At the ALPS inlet, 7 major nuclides, Tc-99, gross β , gross α , and H-3, were checked.

The purpose of this confirmation is to identify possible changes in the transfer of radionuclides to water due to the progress of decommissioning. However, when the situation changes, it is unlikely that only a single radionuclide will change, and changes may occur, including the nuclides that are currently measured periodically. Note that when checking the changes in the transfer status into water, whether it is changed will be determined not based on the result of one radionuclide analysis but based on the results of several analyses or analyses of nuclides with similar properties. Along with the progress of the treatment of stagnant water in buildings, an increase in the concentration of α nuclides has been observed. Since the installation of an α -nuclide removal system (see Figure 1.1.4-10) is currently being planned at the rear stage of the Cs adsorption system, aiming at a state where α -contamination control is not required at T.P. 33.5 m, even if the concentration of α -nuclides in the retained water of the centralized Rw building increases, it is unlikely to directly affect the nuclides to be measured and assessed when ALPS treated water is discharged to the sea. Therefore, in principle, radioactive concentrations in contaminated water before treatment by ALPS will be inspected in this check, although the stagnant water in the centralized Rw building is also used as a reference.

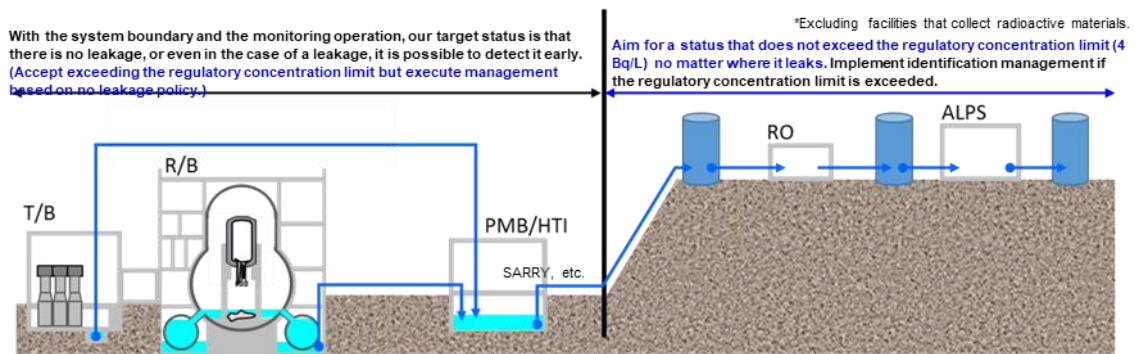

a. Target state of α -nuclide management at 1F and its measures

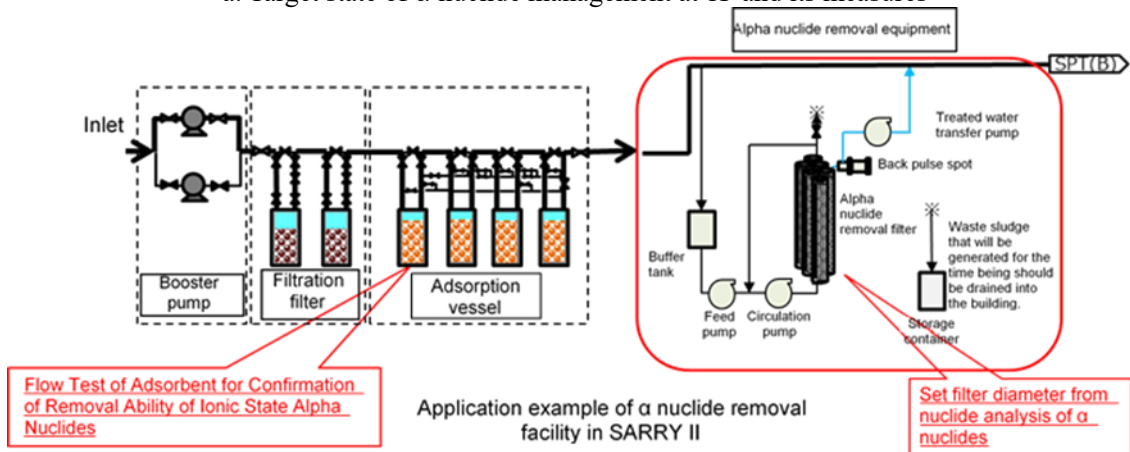

b. Measures to satisfy the target state (α -nuclide removal equipment)

Figure 1.1.4-10 Target state of α -nuclide management at 1F and its measure

3.3 Survey analysis

When an event that raises concerns is found in section 3.1 or 3.2, a survey analysis will be performed in order to survey the other nuclides. Even if such an event does not occur, nuclides to be monitored will be checked once a year to make sure that they do not exist in significant concentration in contaminated water before ALPS treatment in order to survey the presence of other nuclides. Following the Mid-and-Long-Term Decommissioning Action Plan of FY2021, survey analyses can be performed in that frequency even the works which may change the status of radionuclide transfer to contaminated water, such as the retrieval of fuel debris and the modification of water treatment facilities. Even if the these work are implemented, the measures such as planning survey analyses with theses work are taken

Details of the analysis results used in the evaluation of the transfer to contaminated water

In Step 4, nuclides that have proceeded to Step 4 are grouped to the extent of possible, and then "evaluation of the transfer to contaminated water" is performed using actual analysis results. After confirming if the impact on the dose assessment is sufficiently small (1/100 of the regulatory concentration limit or less), nuclides with a sufficiently small impact on the dose assessment are excluded in the relevant step.

In this document, the analytical data used to assess the transfer to contaminated water is shown in Table 1.1.4-32, and the details of the sampling points are shown in Figure 1.1.4-11. In addition, Tables 1.1.4-33 and 1.1.4-34 show the daily inspection methods used to check that the performance of the analyzer used in the analysis in Table 1.1.4-32 is maintained.

Table 1.1.4-32 Analysis data used in transfer assessment (1/4)

Nuclide	Regulatory concentration limit [Bq/L]	Number of data* ¹ (of which, number of detections)	Condition of the sample	Sampling location* ²	Sampling method* ²	Amount of sample [ml]	Measurement time [s]	Sampling date	Reference date	Analyzed value* ³ [Bq/L]	Measuring instrument
H-3	6.0E+04	362(362)	-	[2]-1	Routine	50	Unknown	Aug 30, 2011	Oct 26, 2012	4.3E+06	Liquid scintillation counter
C-14	2.0E+03	47(16)	-	[2]-1	Routine	50	Unknown	Mar 3, 2015	Mar 11, 2011	2.6E+02	Liquid scintillation counter
Cl-36	9.0E+02	22(0)	Filtrate	[2]-1	Routine	10	10,000	Feb 4, 2022	May 23, 2022	< 4.3E+00	Beta spectrometer
Mn-54	1.0E+03	1197(290)	-	[3]-2	Routine	Unknown	Unknown	Jun 19, 2012	Jun 19, 2012	1.1E+05	Ge semiconductor detector
Fe-55	2.0E+03	2(1)	- ⁴	[2]-1	Routine	100 31	200,000 80,000	Nov 2, 2021	Jul 22, 2022 Sep 5, 2022	<4.1E+00 1.7E + 01	Low-energy photon measuring device
Co-58	1.0E+03	27(5)	-	[3]-1	Routine	Unknown	Unknown	Nov 1, 2011	Nov 1, 2011	2.0E+03	Ge semiconductor detector
Co-60	2.0E+02	1646(1450)	Filtrate	[2]-1	Non-routine	50	Unknown	Dec 20, 2018	Mar 11, 2011	1.2E+05	Ge semiconductor detector
Ni-59	1.0E+04	15(2)	- ⁴	[2]-1	Routine	100 31	80,000 80,000	Nov 2, 2021	Jul 26, 2022 Sep 8, 2022	9.4E+00 3.5E+00	Low-energy photon measuring device
Ni-63	6.0E+03	123(74)	Filtrate	[2]-1	Non-routine	50	Unknown	Dec 20, 2018	Mar 11, 2011	5.2E+03	Liquid scintillation counter
Zn-65	2.0E+02	22(0)	-	[3]-2	Routine	500	1,000	Jun 24, 2016	Jun 24, 2016	< 1.6E+00	Ge semiconductor detector
Se-79	2.0E+02	72(21)	-	[2]-1	Routine	5	Unknown	Nov 8, 2011	Jan 19, 2012	8.3E+03	Liquid scintillation counter

*1: The sum of the analysis data in Table 1.1.4-5, Nos. (1) to (3) is shown.

*2: Details are shown in Figure 1.1.4-11.

*3: The maximum value is listed for the detected value, and the minimum value is listed for the lower detection limit.

*4: Since both or either of the filtrate and residue samples was detected, analysis details are described, i.e., the filtrate in the upper column and residues in the lower column.

1.1.4-43

Table 1.1.4-32 Analysis data used in transfer assessment (2/4)

Nuclide	Regulatory concentration limit [Bq/L]	Number of data ^{*1} (of which, number of detections)	Condition of the sample	Sampling location ^{*2}	Sampling method ^{*2}	Amount of sample [ml]	Measurement time [s]	Sampling date	Reference date	Analyzed value ^{*3} [Bq/L]	Measuring instrument
Sr-89	3.0E+02	70(3 ^{*4})	-	[1]-3	Non-routine	Unknown	Unknown	Mar 27, 2011	Apr 13, 2011	7.0E+08	Beta spectrometer
Sr-90	3.0E+01	922(910)	-	[2]-1	Routine	5	Unknown	Nov 1, 2011	Jan 19, 2012	2.9E+08	Beta spectrometer
Zr-93	1.0E+03	2(0)	Filtrate ^{*5}	[2]-1	Routine	1	-	Feb 4, 2022	Jun 7, 2022	< 1.3E+00	Inductively coupled plasma mass spectrometer
Nb-93m	7.0E+03	2(0)	Filtrate ^{*5}	[2]-1	Routine	100	100,000	Nov 2, 2021	Jul 21, 2022	< 5.2E+01	Low-energy photon measuring device
Nb-94	5.0E+02	137(0)	-	[3]-2	Routine	500	25,000	Nov 24, 2022	Nov 24, 2022	< 6.8E-01	Ge semiconductor detector
Mo-93	3.0E+02	2(0)	Residue ^{*6}	[2]-1	Routine	31	80,000	Nov 2, 2021	Sep 7, 2022	< 1.4E+00	Low-energy photon measuring device
Tc-99	1.0E+03	269(231)	Filtrate	[2]-1	Non-routine	50	- ^{*7}	Dec 20, 2018	Mar 11, 2011	1.1E+02	Inductively coupled plasma mass spectrometer
Ru-106	1.0E+02	1264(975)	-	[3]-2	Routine	500	1,000	Oct 31, 2014	Oct 31, 2014	1.2E+05	Ge semiconductor detector
Pd-107	2.0E+04	2(2)	Filtrate	[2]-1	Non-routine	1	- ^{*7}	Apr 21, 2022	Oct 6, 2022	7.8E-02	Inductively coupled plasma mass spectrometer
Ag-110m	3.0E+02	22(0)	-	[3]-2	Routine	500	1,000	Jun 24, 2016	Jun 24, 2016	< 1.0E+01	Ge semiconductor detector
Cd-113m	4.0E+01	22(0)	-	[3]-2	Routine	100	36,000	Jun 14, 2018	Jun 14, 2018	< 1.7E-01	Liquid scintillation counter
Sn-121m	2.0E+03	2(0)	Filtrate ^{*5}	[2]-1	Routine	100	400,000	Nov 2, 2021	Jul 28, 2022	< 9.2E+00	Low-energy photon measuring device
Sn-126	2.0E+02	36(0)	-	[3]-2	Routine	500	25,000	Nov 24, 2022	Nov 24, 2019	< 4.4E+00	Ge semiconductor detector

*1: The sum of the analysis data in Table 1.1.4-5, Nos. (1) to (3) is shown.

*2: Details are shown in Figure 1.1.4-11.

*3: The maximum value is listed for the detected value, and the minimum value is listed for the lower detection limit.

*4: Detections at existing ALPS (17 times) from 2013 to 2014 are excluded because they are pseudo-detection.

*5: Since neither the filtrate nor the residue sample was detected, the amount of the sample used to analyze the filtrate with a larger value was listed.

*6: Since neither the filtrate nor the residue sample was detected, the amount of the sample used to analyze the residue with a larger value was listed.

*7: The measurement time does not contribute to the analytical value because the measurement was taken using an inductively coupled plasma mass spectrometer.

Table 1.1.4-32 Analysis data used in transfer assessment (3/4)

Nuclide	Regulatory concentration limit [Bq/L]	Number of data ^{*1} (of which, number of detections)	Condition of the sample	Sampling location ^{*2}	Sampling method ^{*2}	Amount of sample [ml]	Measurement time [s]	Sampling date	Reference date	Analyzed value ^{*3} [Bq/L]	Measuring instrument
Sb-125	8.0E+02	1656(1624)	-	[3]-2	Routine	500	1000	Mar 25, 2015	Mar 25, 2015	4.3E+05	Ge semiconductor detector
I-129	9.0E+00	502(395)	-	[2]-1	Routine	30	Unknown	Nov 8, 2011	Jun 27, 2013	1.2E+03	Liquid scintillation counter
I-131	4.0E+01	63(24)	-	[2]-1	Routine	Unknown	Unknown	Jun 17, 2011	Jun 17, 2011	6.9E+03	Ge semiconductor detector
Cs-134	6.0E+01	1953(1712)	-	[2]-1	Routine	Unknown	Unknown	Jun 26, 2011	Jun 26, 2011	2.2E+09	Ge semiconductor detector
Cs-137	9.0E+01	2266(2220)	-	[2]-1	Routine	Unknown	Unknown	Jun 26, 2011	Jun 26, 2011	2.4E+09	Ge semiconductor detector
Ba-133	5.0E+02	3(0)	Filtrate	[2]-1	Routine	100	5,000	Feb 4, 2022	Jun 2, 2022	< 2.6E+00	Ge semiconductor detector
Ba-140	3.0E+02	26(2)	-	[1]-3	Non-routine	Unknown	Unknown	Mar 27, 2011	Apr 13, 2011	2.4E+08	Ge semiconductor detector
Ce-144	2.0E+02	25(3)	-	[1]-1	Non-routine	Unknown	Unknown	Aug 7, 2013	Mar 11, 2011	3.7E+05	Ge semiconductor detector
Eu-154	4.0E+02	188(2)	-	[1]-2	Non-routine	Unknown	Unknown	Oct 23, 2015	Mar 11, 2011	1.9E+03	Ge semiconductor detector
U-234	2.0E+01	66(25)	- ^{*4}	[2]-1	Routine	100 43	- ^{*5}	Nov 2, 2021	Jul 14, 2022 Sep 27, 2022	1.3E-01 2.8E-02	Inductively coupled plasma mass spectrometer
U-235	2.0E+01	89(47)	Filtrate	[2]-1	Non-routine	50	- ^{*5}	Dec 21, 2018	Mar 11, 2011	4.9E-03	Inductively coupled plasma mass spectrometer
U-236	2.0E+01	61(27)	Filtrate	[2]-1	Non-routine	50	- ^{*5}	Dec 21, 2018	Mar 11, 2011	2.8E-02	Inductively coupled plasma mass spectrometer
U-238	2.0E+01	94(63)	Filtrate	[2]-1	Non-routine	50	- ^{*5}	Dec 21, 2018	Mar 11, 2011	4.5E-02	Inductively coupled plasma mass spectrometer
Np-237	9.0E+00	38(25)	-	[2]-1	Routine	50	- ^{*5}	Aug 13, 2013	Mar 11, 2011	5.3E-01	Inductively coupled plasma mass spectrometer

*1: The sum of the analysis data in Table 1.1.4-5, Nos. (1) to (3) is shown.

*2: Details are shown in Figure 1.1.4-11.

*3: The maximum value is listed for the detected value, and the minimum value is listed for the lower detection limit.

*4: As both the filtrate and residue samples were detected, analysis details are described, i.e., the filtrate in the upper column and residues in the lower column.

*5: The measurement time does not contribute to the analytical value because the measurement was taken using an inductively coupled plasma mass spectrometer.

Table 1.1.4-32 Analysis data used in transfer assessment (4/4)

Nuclide	Regulatory concentration limit [Bq/L]	Number of data* ¹ (of which, number of detections)	Condition of the sample	Sampling location* ²	Sampling method* ²	Amount of sample [ml]	Measurement time [s]	Sampling date	Reference date	Analyzed value* ³ [Bq/L]	Measuring instrument
Pu-238	4.0E+00	148(55)	-	[2]-1	Routine	10	Unknown	Feb 20, 2018	Mar 11, 2011	9.3 +00 ⁵	Surface barrier silicon semiconductor detector
Pu-239+240	8.0E+00	147(34)	-	[2]-1	Routine	10	Unknown	Feb 20, 2018	Mar 11, 2011	2.0E+00	Surface barrier silicon semiconductor detector
Am-241	5.0E+00	136(20)	-	[2]-1	Routine	10	Unknown	Feb 20, 2018	Mar 11, 2011	3.4E+00 ⁵	Surface barrier silicon semiconductor detector
Cm-242	6.0E+01	10(4)	-* ⁴	[2]-1	Routine	500 15	50,000 50,000	Nov 2, 2021	Jun 28, 2022 Jul 4, 2022	<1.6E-03 9.9E-03	Surface barrier silicon semiconductor detector
Cm-244	7.0E+00	134(15)	-	[2]-1	Routine	10	Unknown	Feb 20, 2018	Mar 11, 2011	3.5E+00	Surface barrier silicon semiconductor detector
Cm-243+244	1.3E+01	2(2)	-* ⁴	[2]-1	Routine	500 ⁵ 15 ⁵	50,000 ⁵ 50,000 ⁵	Nov 2, 2021	Jun 28, 2022 ⁵ Jul 4, 2022 ⁵	2.7E-02 ⁵ 4.4E-01 ⁵	Surface barrier silicon semiconductor detector

*1: The sum of the analysis data in Table 1.1.4-5, Nos. (1) to (3) is shown.

*2: Details are shown in Figure 1.1.4-11.

*3: The maximum value is listed for the detected value, and the minimum value is listed for the lower detection limit.

*4: Since both or either of the filtrate and residue samples was detected, analysis details are described, i.e., the filtrate in the upper column and residues in the lower column.

*5: The data of FRAnDLi were simply corrected for attenuation from the analysis value to the reference date of March 11, 2011. Since these nuclides are also generated from the parent nuclide, attenuation correction considering generation from the parent nuclide was used in this study.

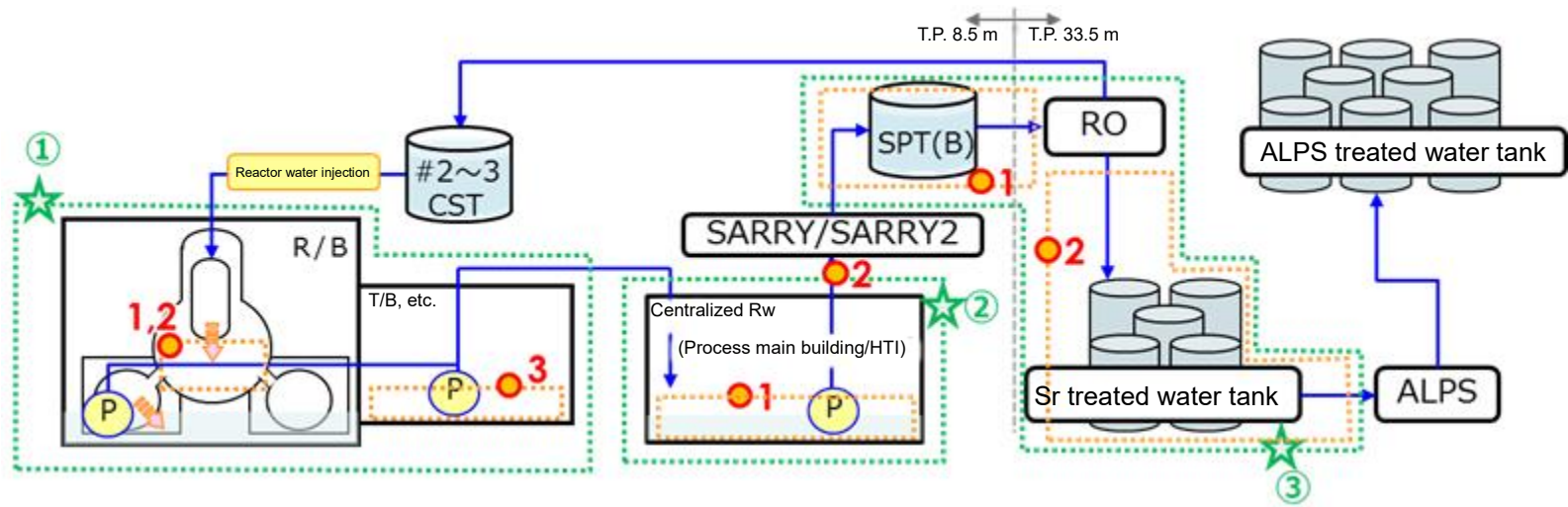

No.	Analysis result of the evaluation sources	Sampling locations used for evaluation	Sampling method
[1]	1	Unit 2 PCV	Sampling by water sampler => See (2).
	2	Stagnant water in the buildings of Units 1 to 4	
	3	Unit 2 T/B	
[2]	1	Stagnant water at the centralized Rw building	Sampling by water sampling pump or sampler => See (3).
	2	Cesium adsorption equipment inlet	Sampling from the sampling line
[3]	1	Cesium adsorption equipment/ decontamination equipment outlet to desalination equipment inlet	Sampling from the sampling line
	2	Desalination equipment outlet to ALPS inlet (including evaporation concentrator inlet*)	Sampling from the sampling line

(1) List of sampling points for contaminated water

Figure 1.1.4-11 Sampling location and method (1/3)

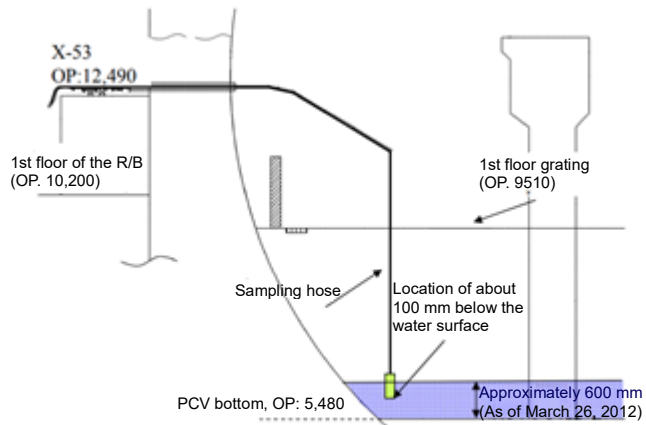

Sampling of stagnant water in Unit 2 PCV [Non-routine] (2013)

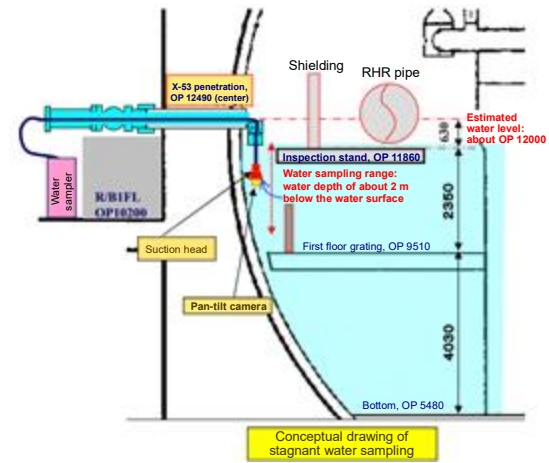

Sampling of stagnant water in Unit 3 PCV [Non-routine] (2015)

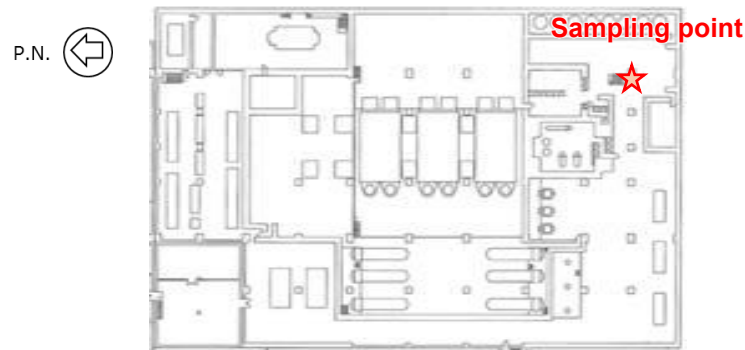

Sampling of stagnant water in Unit 2 T/B [Non-routine] (2011)

*: Although there are no records, it is assumed that the water was sampled by a water sampler at the time of the earthquake.

(2) Sampling method of Units 1 to 4

Figure 1.1.4-11 Sampling location and method (2/3)

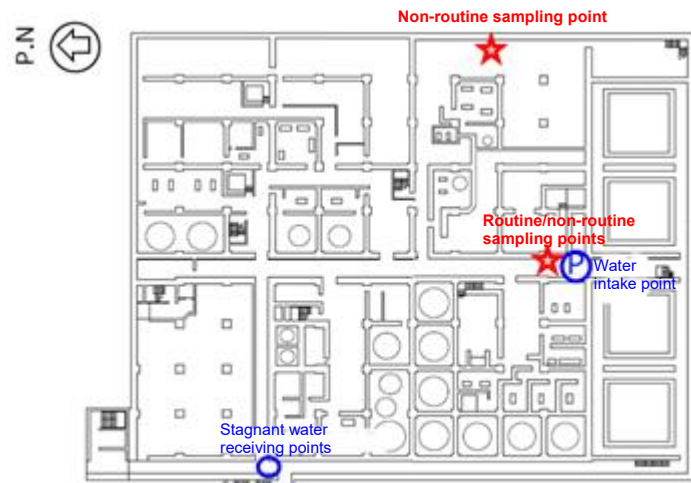

PMB lowest floor plan

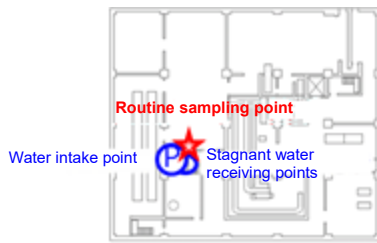

HTI lowest floor plan

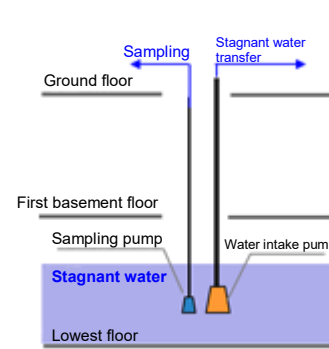

a. Routine sampling

Sampled water with the sampling pump installed to match the suction height of the intake pump.

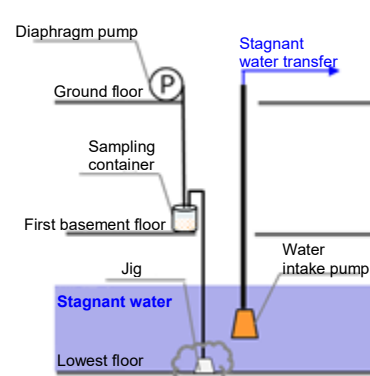

b. Non-routine sampling (1)

Analysis of stagnant water suctioned together during the collection of sludge on the floor of the process main building (2018 : Co-60 , Ni-63 , Tc-99 , U-235 , U-236 and U-238)

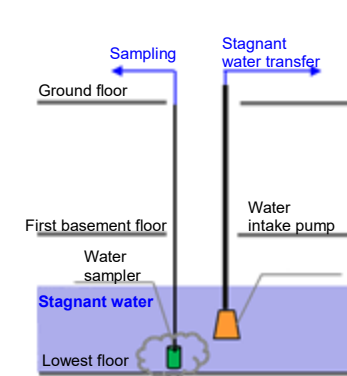

b. Non-routine sampling (2)

Collected samples that stirred up sludge at the bottom of the building during water sampling (Pd-107, 2022).

(3) Sampling method of process main building and high-temperature incinerator building

Figure 1.1.4-11 Sampling location and method (3/3)

Table 1.1.4-33 Method for confirming the reliability of measuring equipment
(results of analysis at 1F on-site facilities)

Measuring instrument	Standard source	Reliability verification method	
		Frequency	Method
Ge semiconductor detector	Co-57, Ba-133, Cs-137 Mn-54, Co-60	At the beginning of daily work	Determine the detection efficiency for each energy of the standard source to confirm to be within the judgment value ($\pm 10\%$).
Liquid scintillation counter	H-3		

Table 1.1.4-34 Reliability verification method of measuring instrument (external analysis results)

(1/2)

Measuring instrument	Standard source	Reliability verification method	
		Frequency	Method
Ge semiconductor detector	Am-241,Cd-109,Co-57,Ce-139,Hg-203,Sn-113,Sr-85,Cs-137,Y-88,Co-60	At each use	Measure the background to confirm that the measured value is within the judgment value (3σ).
	-	At each measurement	Measure the radioactive materials contained in the sample and confirm that the results obtained are appropriate.
Liquid scintillation counter	H-3, C-14	At each use	Check that the calibration source is within the reference value.
Gas flow type beta-ray measuring device	Sr-90	At each use	Measure the standard source to confirm no change in the counted value.
Beta spectrometer	Cl-36	At each use	Measure the background to confirm that the measured value is within the judgment value (3σ).
Si (Li) semiconductor detector	Ca-41	At each use	Measure the background to confirm that the measured value is within the judgment value (3σ).
Surface barrier Silicon semiconductor detector	-	At each measurement	Measure the radioactive materials contained in the sample and confirm that the results obtained are appropriate.
	U-234	At each use	Measure the background to confirm that the measured value is within the judgment value (3σ).

Table 1.1.4-34 Reliability verification method of measuring instrument (external analysis results)

(2/2)

Measuring instrument	Standard source	Reliability verification method	
		Frequency	Method
Low-energy photon measuring device	Am-241 (sealed source)	At each use	Confirm that the fluctuation is within the judgment value ($\pm 10\%$) at the specified energy counting rate.
ICP-MS	Co,In,U	At each use	Measure the strength of each element, and after confirming that it is equal to the judgment value or higher, create a calibration curve before the measurement.
	Li,Ce,Y,Tl	At each use	Measure the strength of each element, and after confirming that it is equal to the judgment value or higher, create a calibration curve before the measurement.
	Zr	At each use	Quantify by the calibration curve created by measuring the standard solution diluted and adjusted from the standard material.

END

Data used for the selection of nuclides in the study of the nuclides to be measured and assessed at the time of the discharge of ALPS treated water into the sea

Inventory assessment is first performed in studying the nuclides to be measured and assessed when discharging the ALPS treated water into the sea. After that, the study is conducted based on the above result in Steps 1 through 3. In Steps 4 and 5, in addition to the above assessment result, a study based on the measured data and the nuclide properties are also carried out.

This document shows a list of data used in the study up to Step 4 in the selection flow of the nuclides to be measured and assessed at the time of discharging the ALPS treated water into the sea. Details are shown in Table 1.1.4-35.

Table 1.1.4-35 List of data used in the nuclide selection process (1/13)

Nuclide	Regulatory concentration limit [Bq/L]	Inventory assessment results [Bq]	Step 3			Step 4							
			Assessed concentration [Bq/L]	Ratio to the regulatory concentration limit	Evaluation result	Group*1	Relative ratio	Evaluation result	Analysis result [Bq/L]	Transfer coefficient [1/L]	Assessed concentration [Bq/L]	Ratio to the regulatory concentration limit	Evaluation result
H-3	6.0E+04	1.7E+15	1.3E+06	2.1E+01	Target	Individual	-	Target	4.3E+06	1.0E-08	1.7E+07	2.8E+02	Target
Be-10	7.0E+02	3.0E+09	2.3E+00	3.2E-03	Excluded								
C-14	2.0E+03	2.5E+13	1.9E+04	9.4E+00	Target	Individual	-	Target	2.6E+02	1.0E-10	2.5E+03	1.3E+00	Target
Na-22	3.0E+02	1.4E+08	1.0E-01	3.4E-04	Excluded								
Si-32	1.0E+03	3.7E+06	2.8E-03	2.8E-06	Excluded								
P-32	3.0E+02	3.7E+06	2.8E-03	9.4E-06	Excluded								
Cl-36	9.0E+02	3.1E+10	2.3E+01	2.6E-02	Target	Individual	-	Target	< 4.3E+00	1.0E-09	3.1E+01	3.4E-02	Target
Ar-39	-	6.5E+11	*2										
Ar-42	-	3.2E+04	*2										
K-40	1.0E+02	4.7E+08	3.5E-01	3.5E-03	Excluded								
K-42	2.0E+03	3.2E+04	2.4E-05	1.2E-08	Excluded								
Ca-41	4.0E+03	1.7E+10	1.3E+01	3.2E-03	Excluded								
Ca-45	1.0E+03	1.8E+07	1.4E-02	1.4E-05	Excluded								
Sc-46	6.0E+02	1.4E+02	1.1E-07	1.8E-10	Excluded								
V-49	4.0E+04	1.0E+05	7.5E-05	1.9E-09	Excluded								
Mn-54	1.0E+03	1.6E+12	1.2E+03	1.2E+00	Target	Individual	-	Target	1.1E+05	1.0E-10	1.6E+02	1.6E-01	Target
Fe-55	2.0E+03	1.1E+16	8.4E+06	4.2E+03	Target	Individual	-	Target	2.1E+01	1.0E-14	1.1E+02	5.6E-02	Target

*1: See Attachment-4, 2.4.3.2 for the group number.

*2: Excluded in Step 2

1.1.4-54

Table 1.1.4-35 List of data used in the nuclide selection process (2/13)

Nuclide	Regulatory concentration limit [Bq/L]	Inventory assessment results [Bq]	Step 3			Step 4							
			Assessed concentration [Bq/L]	Ratio to the regulatory concentration limit	Evaluation result	Group*1	Relative ratio	Evaluation result	Analysis result [Bq/L]	Transfer coefficient [1/L]	Assessed concentration [Bq/L]	Ratio to the regulatory concentration limit	Evaluation result
Co-60	2.0E+02	3.6E+16	2.7E+07	1.4E+05	Target	Individual	-	Target	1.2E+05	1.0E-12	3.6E+04	1.8E+02	Target
Ni-59	1.0E+04	7.3E+13	5.5E+04	5.5E+00	Target	1	5.2E-03	Excluded					
Ni-63	6.0E+03	8.5E+15	6.4E+06	1.1E+03	Target	1	1.0E+00	Target	5.2E+03	1.0E-12	8.5E+03	1.4E+00	Target
Zn-65	2.0E+02	4.0E+09	3.0E+00	1.5E-02	Target	Individual	-	Target	<1.6E+00	1.0E-11	4.0E-02	2.0E-04	Excluded
Se-75	3.0E+02	3.9E+03	3.0E-06	9.9E-09	Excluded								
Se-79	2.0E+02	3.7E+11	2.8E+02	1.4E+00	Target	Individual	-	Target	8.3E+03	1.0E-07	3.7E+04	1.8E+02	Target
Kr-81	-	4.5E+10	*2										
Kr-85	-	3.3E+16	*2										
Rb-87	6.0E+02	3.1E+08	2.4E-01	3.9E-04	Excluded								
Sr-90	3.0E+01	3.9E+17	3.0E+08	9.9E+06	Target	2	1.0E+00	Target	2.9E+08	1.0E-09	3.9E+08	1.3E+07	Target
Y-88	7.0E+02	2.1E+00	1.6E-09	2.3E-12	Excluded								
Y-90	3.0E+02	3.9E+17	3.0E+08	9.9E+05	Target	2	1.0E-01	Target	-	1.0E-09	3.9E+08	1.3E+06	Target
Zr-93	1.0E+03	1.4E+13	1.0E+04	1.0E+01	Target	Individual	-	Excluded	< 1.3E+00	1.0E-13	1.4E+00	1.4E-03	Excluded
Nb-91	2.0E+04	9.3E+05	7.0E-04	3.5E-08	Excluded								
Nb-92	9.0E+02	9.4E+06	7.1E-03	7.9E-06	Excluded								
Nb-93m	7.0E+03	6.3E+12	4.8E+03	6.8E-01	Target	3	1.0E+00	Target	< 5.2E+01	1.0E-10	6.3E+02	9.0E-02	Target
Nb-94	5.0E+02	9.0E+11	6.7E+02	1.3E+00	Target	3	2.0E+00	Target	< 6.8E-01	1.0E-10	9.0E+01	1.8E-01	Target

*1: See Attachment-4, 2.4.3.2 for the group number.

*2: Excluded in Step 2

Table 1.1.4-35 List of data used in the nuclide selection process (3/13)

Nuclide	Regulatory concentration limit [Bq/L]	Inventory assessment results [Bq]	Step 3			Step 4							
			Assessed concentration [Bq/L]	Ratio to the regulatory concentration limit	Evaluation result	Group*1	Relative ratio	Evaluation result	Analysis result [Bq/L]	Transfer coefficient [1/L]	Assessed concentration [Bq/L]	Ratio to the regulatory concentration limit	Evaluation result
Mo-93	3.0E+02	1.4E+12	1.1E+03	3.6E+00	Target	Individual	-	Target	< 1.4E+00	1.0E-12	1.4E+00	4.8E-03	Target
Tc-97	1.0E+04	1.1E+07	8.4E-03	8.4E-07	Excluded								
Tc-98	4.0E+02	3.1E+07	2.3E-02	5.8E-05	Excluded								
Tc-99	1.0E+03	9.4E+13	7.1E+04	7.1E+01	Target	Individual	-	Target	1.1E+02	1.0E-11	9.4E+02	9.4E-01	Target
Ru-106	1.0E+02	7.5E+14	5.7E+05	5.7E+03	Target	4	1.0E+00	Target	1.2E+05	1.0E-12	7.5E+02	7.5E+00	Target
Rh-101	2.0E+03	4.1E+05	3.1E-04	1.6E-07	Excluded								
Rh-102	4.0E+02	2.6E+07	2.0E-02	4.9E-05	Excluded								
Rh-102m	7.0E+02	5.7E+07	4.3E-02	6.1E-05	Excluded								
Rh-106	3.0E+05	7.6E+14	5.7E+05	1.9E+00	Target	4	3.3E-04	Excluded					
Pd-107	2.0E+04	6.1E+11	4.6E+02	2.3E-02	Target	4	4.1E-06	Excluded					
Ag-108	2.0E+05	1.5E+10	1.1E+01	5.6E-05	Excluded								
Ag-108m	4.0E+02	1.7E+11	1.3E+02	3.2E-01	Target	5	1.5E+00	Target	-	1.0E-12	1.7E-01	4.3E-04	Excluded
Ag-109m	5.0E+06	3.6E+10	2.7E+01	5.4E-06	Excluded								
Ag-110	5.0E+05	1.2E+09	9.0E-01	1.8E-06	Excluded								
Ag-110m	3.0E+02	8.8E+10	6.6E+01	2.2E-01	Target	5	1.0E+00	Target	< 1.0E+01	1.0E-12	8.8E-02	2.9E-04	Excluded
Cd-109	4.0E+02	3.6E+10	2.7E+01	6.7E-02	Target	6	4.4E-05	Excluded					
Cd-113m	4.0E+01	8.2E+13	6.1E+04	1.5E+03	Target	6	1.0E+00	Target	< 1.7E-01	1.0E-14	8.2E-01	2.0E-02	Target

*1: See Attachment-4, 2.4.3.2 for the group number.

Table 1.1.4-35 List of data used in the nuclide selection process (4/13)

Nuclide	Regulatory concentration limit [Bq/L]	Inventory assessment results [Bq]	Step 3			Step 4							
			Assessed concentration [Bq/L]	Ratio to the regulatory concentration limit	Evaluation result	Group*1	Relative ratio	Evaluation result	Analysis result [Bq/L]	Transfer coefficient [1/L]	Assessed concentration [Bq/L]	Ratio to the regulatory concentration limit	Evaluation result
In-113m	3.0E+04	6.6E+04	4.9E-05	1.6E-09	<i>Excluded</i>								
In-115	3.0E+01	1.4E+04	1.1E-05	3.6E-07	<i>Excluded</i>								
Sn-113	1.0E+03	6.6E+04	4.9E-05	4.9E-08	<i>Excluded</i>								
Sn-119m	2.0E+03	5.9E+10	4.4E+01	2.2E-02	Target	7	6.5E-04	<i>Excluded</i>					
Sn-121	4.0E+03	7.1E+13	5.3E+04	1.3E+01	Target	7	3.9E-01	Target	-	1.0E-13	7.1E+00	1.8E-03	<i>Excluded</i>
Sn-121m	2.0E+03	9.1E+13	6.9E+04	3.4E+01	Target	7	1.0E+00	Target	< 9.2E+00	1.0E-13	9.1E+00	4.6E-03	<i>Excluded</i>
Sn-123	4.0E+02	4.4E+05	3.3E-04	8.3E-07	<i>Excluded</i>								
Sn-126	2.0E+02	1.6E+12	1.2E+03	6.1E+00	Target	7	1.8E-01	Target	< 3.9E+00	1.0E-13	1.6E-01	8.1E-04	<i>Excluded</i>
Sb-125	8.0E+02	2.9E+15	2.2E+06	2.7E+03	Target	8	1.0E+00	Target	4.3E+05	1.0E-11	2.9E+04	3.6E+01	Target
Sb-126	4.0E+02	2.3E+11	1.7E+02	4.2E-01	Target	7	1.2E-02	Target	-	1.0E-13	2.3E-02	5.6E-05	<i>Excluded</i>
Sb-126m	2.0E+04	1.6E+12	1.2E+03	6.1E-02	Target	7	1.8E-03	<i>Excluded</i>					
Te-121	2.0E+03	2.5E+03	1.9E-06	9.3E-10	<i>Excluded</i>								
Te-121m	4.0E+02	2.5E+03	1.9E-06	4.7E-09	<i>Excluded</i>								
Te-123	2.0E+02	3.6E+04	2.7E-05	1.4E-07	<i>Excluded</i>								
Te-123m	6.0E+02	5.5E+04	4.2E-05	6.9E-08	<i>Excluded</i>								
Te-125m	9.0E+02	1.1E+15	8.0E+05	8.9E+02	Target	8	3.3E-01	Target	-	1.0E-11	1.1E+04	1.2E+01	Target
Te-127	5.0E+03	3.2E+04	2.4E-05	4.8E-09	<i>Excluded</i>								

*1: See Attachment-4, 2.4.3.2 for the group number.

1.1.4-57

Table 1.1.4-35 List of data used in the nuclide selection process (5/13)

Nuclide	Regulatory concentration limit [Bq/L]	Inventory assessment results [Bq]	Step 3			Step 4							
			Assessed concentration [Bq/L]	Ratio to the regulatory concentration limit	Evaluation result	Group*1	Relative ratio	Evaluation result	Analysis result [Bq/L]	Transfer coefficient [1/L]	Assessed concentration [Bq/L]	Ratio to the regulatory concentration limit	Evaluation result
Te-127m	3.0E+02	3.2E+04	2.4E-05	8.1E-08	Excluded								
I-129	9.0E+00	1.6E+11	1.2E+02	1.4E+01	Target	Individual	-	Target	1.2E+03	1.0E-08	1.6E+03	1.8E+02	Target
Cs-134	6.0E+01	2.5E+16	1.8E+07	3.1E+05	Target	9	7.0E-02	Target	2.2E+09	1.0E-08	2.5E+08	4.1E+06	Target
Cs-135	6.0E+02	3.5E+12	2.6E+03	4.4E+00	Target	9	9.9E-07	Excluded					
Cs-137	9.0E+01	5.3E+17	4.0E+08	4.4E+06	Target	9	1.0E+00	Target	2.4E+09	1.0E-08	5.3E+09	5.9E+07	Target
Ba-133	5.0E+02	1.7E+11	1.3E+02	2.5E-01	Target	Individual	-	Target	< 2.6E+00	1.0E-09	1.7E+02	3.3E-01	Target
Ba-137m	8.0E+05	5.0E+17	3.8E+08	4.7E+02	Target	9	1.1E-04	Excluded					
La-137	1.0E+04	4.8E+07	3.6E-02	3.6E-06	Excluded								
La-138	8.0E+02	1.1E+05	8.6E-05	1.1E-07	Excluded								
Ce-139	3.0E+03	2.0E+04	1.5E-05	5.0E-09	Excluded								
Ce-142	7.0E-01	1.8E+08	1.4E-01	2.0E-01	Target	10	8.3E-06	Excluded					
Ce-144	2.0E+02	1.7E+14	1.3E+05	6.3E+02	Target	10	2.7E-02	Target	3.7E+05	1.0E-13	1.7E+01	8.4E-02	Target
Pr-144	2.0E+04	1.7E+14	1.3E+05	6.3E+00	Target	10	2.7E-04	Excluded					
Pr-144m	4.0E+04	2.5E+12	1.9E+03	4.8E-02	Target	10	2.0E-06	Excluded					
Nd-144	2.0E+01	1.1E+04	8.4E-06	4.2E-07	Excluded								
Pm-144	9.0E+02	1.0E+02	7.8E-08	8.6E-11	Excluded								
Pm-145	7.0E+03	7.8E+10	5.8E+01	8.4E-03	Excluded								

*1: See Attachment-4, 2.4.3.2 for the group number.

1.1.4-58

Table 1.1.4-35 List of data used in the nuclide selection process (6/13)

Nuclide	Regulatory concentration limit [Bq/L]	Inventory assessment results [Bq]	Step 3			Step 4							
			Assessed concentration [Bq/L]	Ratio to the regulatory concentration limit	Evaluation result	Group*1	Relative ratio	Evaluation result	Analysis result [Bq/L]	Transfer coefficient [1/L]	Assessed concentration [Bq/L]	Ratio to the regulatory concentration limit	Evaluation result
Pm-146	9.0E+02	3.6E+12	2.7E+03	3.0E+00	Target	10	1.3E-04	Excluded					
Pm-147	3.0E+03	5.6E+16	4.2E+07	1.4E+04	Target	10	5.9E-01	Target	-	1.0E-13	5.6E+03	1.9E+00	Target
Sm-145	4.0E+03	1.2E+08	8.9E-02	2.2E-05	Excluded								
Sm-146	2.0E+01	7.1E+05	5.3E-04	2.7E-05	Excluded								
Sm-147	2.0E+01	4.7E+07	3.5E-02	1.8E-03	Excluded								
Sm-148	2.0E+01	2.6E+02	2.0E-07	9.9E-09	Excluded								
Sm-149	2.0E-01	6.1E+00	4.6E-09	2.3E-08	Excluded								
Sm-151	8.0E+03	2.2E+15	1.6E+06	2.0E+02	Target	10	8.5E-03 ^{*2}	Target	-	1.0E-13	2.2E+02	2.7E-02	Target
Eu-150	7.0E+02	1.2E+08	8.9E-02	1.3E-04	Excluded								
Eu-152	6.0E+02	9.0E+12	6.8E+03	1.1E+01	Target	10	4.8E-04	Excluded					
Eu-154	4.0E+02	1.3E+16	9.5E+06	2.4E+04	Target	10	1.0E+00	Target	1.9E+03	1.0E-13	1.3E+03	3.2E+00	Target
Eu-155	3.0E+03	3.8E+15	2.8E+06	9.5E+02	Target	10	4.0E-02	Target	-	1.0E-13	3.8E+02	1.3E-01	Target
Gd-152	2.0E+01	1.4E+01	1.0E-08	5.1E-10	Excluded								
Gd-153	3.0E+03	1.1E+09	8.0E-01	2.7E-04	Excluded								
Tb-157	2.0E+04	2.6E+09	1.9E+00	9.7E-05	Excluded								
Tb-158	8.0E+02	2.1E+09	1.6E+00	2.0E-03	Excluded								
Dy-159	8.0E+03	6.9E+01	5.2E-08	6.5E-12	Excluded								

*1: See Attachment-4, 2.4.3.2 for the group number.

*2: Not excluded because the half-life is longer than the representative nuclide Eu -154, and the relative ratio exceeds 0.01 during the discharge period.

1.1.4-59

Table 1.1.4-35 List of data used in the nuclide selection process (7/13)

Nuclide	Regulatory concentration limit [Bq/L]	Inventory assessment results [Bq]	Step 3			Step 4							
			Assessed concentration [Bq/L]	Ratio to the regulatory concentration limit	Evaluation result	Group*1	Relative ratio	Evaluation result	Analysis result [Bq/L]	Transfer coefficient [1/L]	Assessed concentration [Bq/L]	Ratio to the regulatory concentration limit	Evaluation result
Ho-163	1.0E+05	5.9E+07	4.5E-02	4.5E-07	<i>Excluded</i>								
Ho-166m	4.0E+02	2.6E+10	1.9E+01	4.8E-02	Target	10	2.0E-06	<i>Excluded</i>					
Tm-170	6.0E+02	1.9E+06	1.4E-03	2.4E-06	<i>Excluded</i>								
Tm-171	7.0E+03	5.3E+12	4.0E+03	5.7E-01	Target	10	2.4E-05	<i>Excluded</i>					
Lu-176	5.0E+02	1.9E+06	1.5E-03	2.9E-06	<i>Excluded</i>								
Lu-177	2.0E+03	1.8E+06	1.3E-03	6.6E-07	<i>Excluded</i>								
Lu-177m	5.0E+02	7.7E+06	5.8E-03	1.2E-05	<i>Excluded</i>								
Hf-182	3.0E+02	8.0E+06	6.0E-03	2.0E-05	<i>Excluded</i>								
Ta-182	6.0E+02	8.2E+06	6.1E-03	1.0E-05	<i>Excluded</i>								
W-181	1.0E+04	3.2E+03	2.4E-06	2.4E-10	<i>Excluded</i>								
Re-187	2.0E+05	5.8E+06	4.3E-03	2.2E-08	<i>Excluded</i>								
Os-194	3.0E+02	5.3E+08	4.0E-01	1.3E-03	<i>Excluded</i>								
Ir-192	6.0E+02	2.0E+07	1.5E-02	2.5E-05	<i>Excluded</i>								
Ir-192m	3.0E+03	2.0E+07	1.5E-02	4.9E-06	<i>Excluded</i>								
Ir-194	6.0E+02	5.3E+08	4.0E-01	6.6E-04	<i>Excluded</i>								
Ir-194m	4.0E+02	1.2E+04	9.3E-06	2.3E-08	<i>Excluded</i>								
Pt-190	1.0E+02	6.5E+03	4.9E-06	4.9E-08	<i>Excluded</i>								

*1: See Attachment-4, 2.4.3.2 for the group number.

Table 1.1.4-35 List of data used in the nuclide selection process (8/13)

Nuclide	Regulatory concentration limit [Bq/L]	Inventory assessment results [Bq]	Step 3			Step 4							
			Assessed concentration [Bq/L]	Ratio to the regulatory concentration limit	Evaluation result	Group*1	Relative ratio	Evaluation result	Analysis result [Bq/L]	Transfer coefficient [1/L]	Assessed concentration [Bq/L]	Ratio to the regulatory concentration limit	Evaluation result
Pt-193	3.0E+04	9.7E+12	7.3E+03	2.4E-01	Target	4	4.3E-05	Excluded					
Tl-204	7.0E+02	1.4E+13	1.1E+04	1.5E+01	Target	9	3.5E-06	Excluded					
Tl-206	1.0E+05	6.5E+05	4.9E-04	4.9E-09	Excluded								
Tl-207	1.0E+05	7.2E+07	5.4E-02	5.4E-07	Excluded								
Tl-208	1.0E+05	4.3E+10	3.2E+01	3.2E-04	Excluded								
Tl-209	1.0E+05	2.8E+04	2.1E-05	2.1E-10	Excluded								
Pb-205	3.0E+03	2.8E+06	2.1E-03	7.1E-07	Excluded								
Pb-209	1.0E+04	1.3E+06	9.8E-04	9.8E-08	Excluded								
Pb-210	1.0E+00	5.3E+06	4.0E-03	4.0E-03	Excluded								
Pb-211	4.0E+03	7.2E+07	5.4E-02	1.4E-05	Excluded								
Pb-212	1.0E+02	1.2E+11	8.9E+01	8.9E-01	Target	11-3	1.7E-03	Excluded					
Pb-214	5.0E+03	1.6E+07	1.2E-02	2.5E-06	Excluded								
Bi-208	8.0E+02	2.5E+06	1.9E-03	2.3E-06	Excluded								
Bi-210	6.0E+02	5.3E+06	4.0E-03	6.6E-06	Excluded								
Bi-210m	5.0E+01	6.5E+05	4.9E-04	9.8E-06	Excluded								
Bi-211	7.0E+04	7.2E+07	5.4E-02	7.7E-07	Excluded								
Bi-212	3.0E+03	1.2E+11	8.9E+01	3.0E-02	Target	11-3	5.8E-05	Excluded					

*1: See Attachment-4, 2.4.3.2 for the group number.

1.1.4-61

Table 1.1.4-35 List of data used in the nuclide selection process (9/13)

Nuclide	Regulatory concentration limit [Bq/L]	Inventory assessment results [Bq]	Step 3			Step 4							
			Assessed concentration [Bq/L]	Ratio to the regulatory concentration limit	Evaluation result	Group*1	Relative ratio	Evaluation result	Analysis result [Bq/L]	Transfer coefficient [1/L]	Assessed concentration [Bq/L]	Ratio to the regulatory concentration limit	Evaluation result
Bi-213	4.0E+03	1.3E+06	9.8E-04	2.4E-07	Excluded								
Bi-214	7.0E+03	1.6E+07	1.2E-02	1.8E-06	Excluded								
Po-210	6.0E-01	5.3E+06	4.0E-03	6.6E-03	Excluded								
Po-211	4.0E+03	2.0E+05	1.5E-04	3.8E-08	Excluded								
Po-212	4.0E+03	7.6E+10	5.7E+01	1.4E-02	Target	11-3	2.8E-05	Excluded					
Po-213	4.0E+03	1.3E+06	9.6E-04	2.4E-07	Excluded								
Po-214	4.0E+03	1.6E+07	1.2E-02	3.1E-06	Excluded								
Po-215	4.0E+03	7.2E+07	5.4E-02	1.4E-05	Excluded								
Po-216	4.0E+03	1.2E+11	8.9E+01	2.2E-02	Target	11-3	4.4E-05	Excluded					
Po-218	2.0E+04	1.6E+07	1.2E-02	6.1E-07	Excluded								
At-217	4.0E+03	1.3E+06	9.8E-04	2.4E-07	Excluded								
Rn-219	4.0E+03	7.2E+07	5.4E-02	1.4E-05	Excluded								
Rn-220	4.0E+03	1.2E+11	8.9E+01	2.2E-02	Target	11-3	4.4E-05	Excluded					
Rn-222	5.0E+00	1.6E+07	1.2E-02	2.5E-03	Excluded								
Fr-221	5.0E+03	1.3E+06	9.8E-04	2.0E-07	Excluded								
Fr-223	3.0E+02	9.9E+05	7.5E-04	2.5E-06	Excluded								
Ra-223	5.0E+00	7.2E+07	5.4E-02	1.1E-02	Target	11-2	2.1E-05	Excluded					

*1: See Attachment-4, 2.4.3.2 for the group number.

1.1.4-62

Table 1.1.4-35 List of data used in the nuclide selection process (10/13)

Nuclide	Regulatory concentration limit [Bq/L]	Inventory assessment results [Bq]	Step 3			Step 4							
			Assessed concentration [Bq/L]	Ratio to the regulatory concentration limit	Evaluation result	Group*1	Relative ratio	Evaluation result	Analysis result [Bq/L]	Transfer coefficient [1/L]	Assessed concentration [Bq/L]	Ratio to the regulatory concentration limit	Evaluation result
Ra-224	9.0E+00	1.2E+11	8.9E+01	9.9E+00	Target	11-3	1.9E-02	Target	-	1.0E-13	1.2E-02	1.3E-03	Excluded
Ra-225	5.0E+00	1.3E+06	9.8E-04	2.0E-04	Excluded								
Ra-226	2.0E+00	1.6E+07	1.2E-02	6.1E-03	Excluded								
Ra-228	7.0E-01	1.8E+07	1.3E-02	1.9E-02	Target	11-3	3.8E-05	Excluded					
Ac-225	3.0E+01	1.3E+06	9.8E-04	3.3E-05	Excluded								
Ac-227	8.0E-01	7.2E+07	5.4E-02	6.8E-02	Target	11-2	1.3E-04	Excluded					
Ac-228	2.0E+03	1.8E+07	1.3E-02	6.7E-06	Excluded								
Th-227	8.0E+01	7.1E+07	5.3E-02	6.7E-04	Excluded								
Th-228	9.0E+00	1.2E+11	8.9E+01	9.9E+00	Target	11-3	1.9E-02	Target	-	1.0E-13	1.2E-02	1.3E-03	Excluded
Th-229	2.0E+00	1.3E+06	9.8E-04	4.9E-04	Excluded								
Th-230	4.0E+00	2.4E+09	1.8E+00	4.5E-01	Target	11-1	8.9E-04	Excluded					
Th-231	2.0E+03	3.7E+11	2.8E+02	1.4E-01	Target	11-2	2.7E-04	Excluded					
Th-232	4.0E+00	1.8E+07	1.4E-02	3.4E-03	Excluded								
Th-234	2.0E+02	3.0E+12	2.3E+03	1.1E+01	Target	11-1	2.2E-02	Target	-	1.0E-13	3.0E-01	1.5E-03	Excluded
Pa-231	1.0E+00	2.6E+08	2.0E-01	2.0E-01	Target	11-2	3.8E-04	Excluded					
Pa-233	9.0E+02	1.7E+12	1.3E+03	1.4E+00	Target	12	1.0E-02	Target	-	1.0E-12	1.7E+00	1.9E-03	Excluded
Pa-234	2.0E+03	3.9E+09	3.0E+00	1.5E-03	Excluded								

*1: See Attachment-4, 2.4.3.2 for the group number.

1.1.4-63

Table 1.1.4-35 List of data used in the nuclide selection process (11/13)

Nuclide	Regulatory concentration limit [Bq/L]	Inventory assessment results [Bq]	Step 3			Step 4								
			Assessed concentration [Bq/L]	Ratio to the regulatory concentration limit	Evaluation result	Group*1	Relative ratio	Evaluation result	Analysis result [Bq/L]	Transfer coefficient [1/L]	Assessed concentration [Bq/L]	Ratio to the regulatory concentration limit	Evaluation result	
Pa-234m	3.0E+05	3.0E+12	2.3E+03	7.6E-03	<i>Excluded</i>									
U-232	3.0E+00	1.2E+11	9.2E+01	3.1E+01	Target	11	6.0E-02	Target	-	1.0E-13	1.2E-02	4.1E-03	<i>Excluded</i>	
U-233	2.0E+01	4.0E+08	3.0E-01	1.5E-02	Target	11	3.0E-05	<i>Excluded</i>						
U-234	2.0E+01	1.4E+13	1.0E+04	5.1E+02	Target	11	1.0E+00	Target	1.6E-01	1.0E-13	1.4E+00	6.8E-02	Target	
U-235	2.0E+01	3.7E+11	2.8E+02	1.4E+01	Target	11	2.7E-02	Target	4.9E-03	1.0E-13	3.7E-02	1.8E-03	<i>Excluded</i>	
U-236	2.0E+01	2.0E+12	1.5E+03	7.5E+01	Target	11	1.5E-01	Target	2.8E-02	1.0E-13	2.0E-01	9.9E-03	<i>Excluded</i>	
U-237	1.0E+03	1.1E+13	8.0E+03	8.0E+00	Target	13	2.7E-06	<i>Excluded</i>						
U-238	2.0E+01	3.0E+12	2.3E+03	1.1E+02	Target	11	2.2E-01	Target	4.5E-02	1.0E-13	3.0E-01	1.5E-02	Target	
U-240	7.0E+02	1.7E+06	1.3E-03	1.9E-06	<i>Excluded</i>									
Np-235	1.0E+04	7.6E+06	5.7E-03	5.7E-07	<i>Excluded</i>									
Np-236	6.0E+01	2.6E+07	1.9E-02	3.2E-04	<i>Excluded</i>									
Np-237	9.0E+00	1.7E+12	1.3E+03	1.4E+02	Target	12	1.0E+00	Target	5.3E-01	1.0E-12	1.7E+00	1.9E-01	Target	
Np-238	9.0E+02	4.5E+11	3.4E+02	3.8E-01	Target	14	1.9E-07	<i>Excluded</i>						
Np-239	1.0E+03	8.5E+13	6.4E+04	6.4E+01	Target	14	3.2E-05	<i>Excluded</i>						
Np-240m	5.0E+04	1.7E+06	1.3E-03	2.6E-08	<i>Excluded</i>									
Pu-236	1.0E+01	1.1E+11	8.2E+01	8.2E+00	Target	13	2.7E-06	<i>Excluded</i>						
Pu-238	4.0E+00	1.6E+16	1.2E+07	3.0E+06	Target	13	1.0E+00	Target	9.3E + 00 ²²	1.0E-15	1.6E+01	4.0E+00	Target	

*1: See Attachment-4, 2.4.3.2 for the group number.

*2: The data of FRAnDLi were simply corrected for attenuation from the analysis value to the reference date of March 11, 2011. Since it is also generated from the parent nuclide, attenuation correction considering generation from the parent nuclide was used in this study.

Table 1.1.4-35 List of data used in the nuclide selection process (12/13)

Nuclide	Regulatory concentration limit [Bq/L]	Inventory assessment results [Bq]	Step 3			Step 4							
			Assessed concentration [Bq/L]	Ratio to the regulatory concentration limit	Evaluation result	Group ^{*1}	Relative ratio	Evaluation result	Analysis result [Bq/L]	Transfer coefficient [1/L]	Assessed concentration [Bq/L]	Ratio to the regulatory concentration limit	Evaluation result
Pu-239	4.0E+00	2.6E+15	2.0E+06	5.0E+05	Target	13	1.7E-01	Target	2.0E+00 ^{*2}	1.0E-15	2.6E+00	6.6E-01	Target
Pu-240	4.0E+00	3.3E+15	2.5E+06	6.3E+05	Target	13	2.1E-01	Target	2.0E+00 ^{*2}	1.0E-15	3.3E+00	8.4E-01	Target
Pu-241	2.0E+02	4.3E+17	3.3E+08	1.6E+06	Target	13	5.5E-01	Target	-	1.0E-15	4.3E+02	2.2E+00	Target
Pu-242	4.0E+00	1.1E+13	8.4E+03	2.1E+03	Target	13	7.1E-04	Excluded					
Pu-243	9.0E+03	5.4E+05	4.0E-04	4.5E-08	Excluded								
Pu-244	4.0E+00	1.7E+06	1.3E-03	3.2E-04	Excluded								
Am-241	5.0E+00	1.3E+16	9.9E+06	2.0E+06	Target	14	1.0E+00	Target	3.4E+00 ^{*3}	1.0E-15	1.3E+01	2.6E+00	Target
Am-242	3.0E+03	9.0E+13	6.7E+04	2.2E+01	Target	14	1.1E-05	Excluded					
Am-242m	5.0E+00	9.0E+13	6.8E+04	1.4E+04	Target	14	6.9E-03	Excluded					
Am-243	5.0E+00	8.5E+13	6.4E+04	1.3E+04	Target	14	6.5E-03	Excluded					
Am-245	1.0E+04	6.3E+00	4.7E-09	4.7E-13	Excluded								
Cm-242	6.0E+01	7.4E+13	5.6E+04	9.3E+02	Target	14	4.7E-04	Excluded					
Cm-243	6.0E+00	7.5E+13	5.7E+04	9.4E+03	Target	14	4.8E-03	Excluded					
Cm-244	7.0E+00	6.5E+15	4.8E+06	6.9E+05	Target	14	3.5E-01	Target	3.5E+00	1.0E-15	6.5E+00	9.2E-01	Target
Cm-245	5.0E+00	1.1E+12	8.2E+02	1.6E+02	Target	14	8.3E-05	Excluded					
Cm-246	5.0E+00	1.8E+11	1.3E+02	2.6E+01	Target	14	1.3E-05	Excluded					
Cm-247	5.0E+00	5.4E+05	4.0E-04	8.1E-05	Excluded								

*1: See Attachment-4, 2.4.3.2 for the group number. *2: Results of analysis of Pu-239 + 240 are listed.

*3: The data of FRAnDLi were simply corrected for attenuation from the analysis value to the reference date of March 11, 2011. Since it is also generated from the parent nuclide, attenuation correction considering generation from the parent nuclide was used in this study.

Table 1.1.4-35 List of data used in the nuclide selection process (13/13)

Nuclide	Regulatory concentration limit [Bq/L]	Inventory assessment results [Bq]	Step 3			Step 4							
			Assessed concentration [Bq/L]	Ratio to the regulatory concentration limit	Evaluation result	Group*1	Relative ratio	Evaluation result	Analysis result [Bq/L]	Transfer coefficient [1/L]	Assessed concentration [Bq/L]	Ratio to the regulatory concentration limit	Evaluation result
Cm-248	1.0E+00	1.4E+06	1.0E-03	1.0E-03	<i>Excluded</i>								
Bk-249	9.0E+02	4.3E+05	3.3E-04	3.6E-07	<i>Excluded</i>								
Cf-249	2.0E+00	1.3E+07	9.7E-03	4.9E-03	<i>Excluded</i>								
Cf-250	5.0E+00	7.1E+07	5.3E-02	1.1E-02	Target	14	5.4E-09	<i>Excluded</i>					
Cf-251	2.0E+00	7.1E+05	5.4E-04	2.7E-04	<i>Excluded</i>								
Cf-252	7.0E+00	9.6E+06	7.2E-03	1.0E-03	<i>Excluded</i>								

*1: See Attachment-4, 2.4.3.2 for the group number.