

2023年9月29日
東京電力ホールディングス株式会社
福島第一廃炉推進カンパニー

建屋内の空間線量率について

データ採取期間

- ・ 5号機 : 2022年4月1日～2023年3月31日

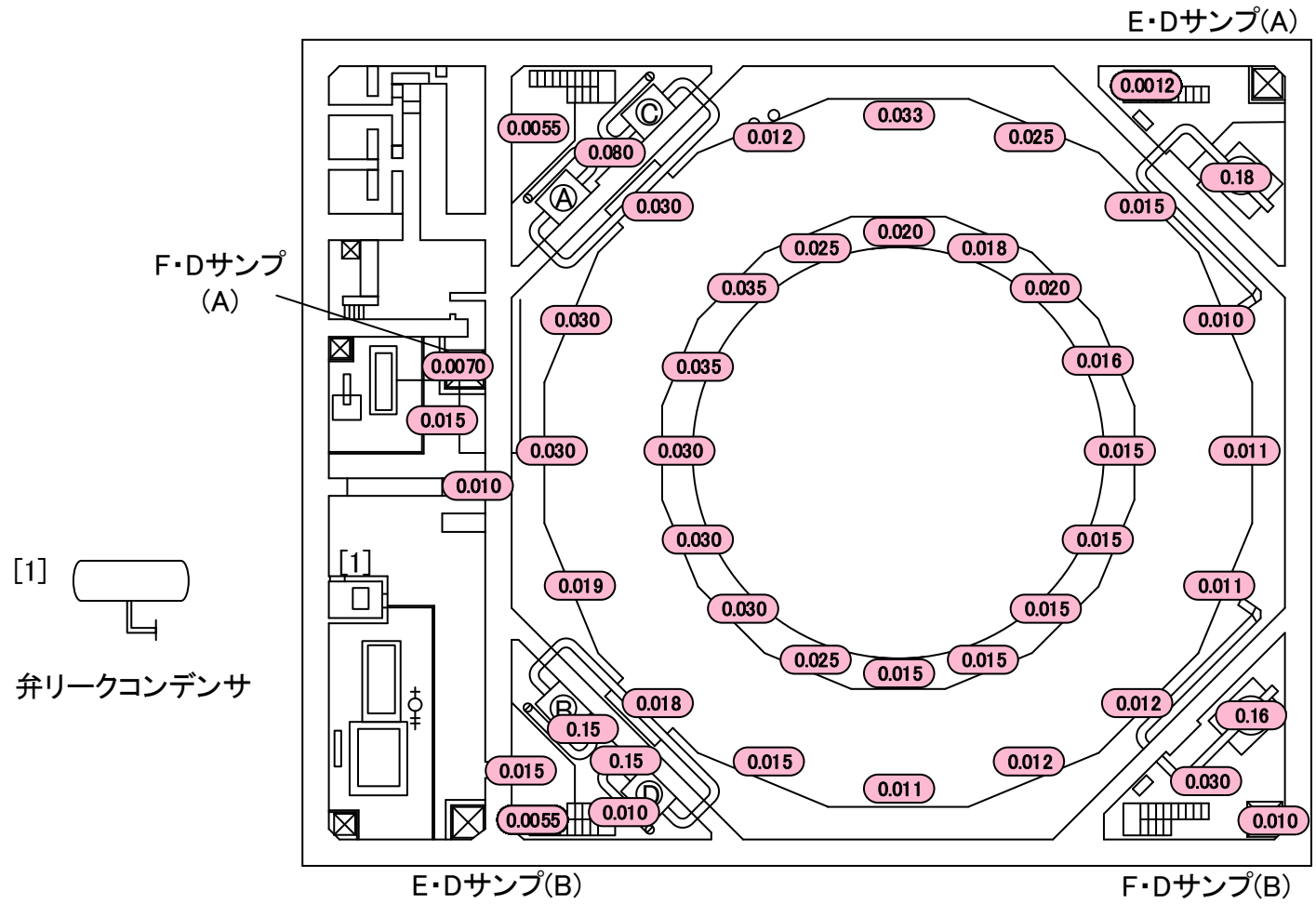

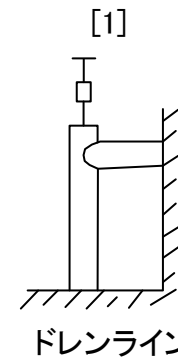
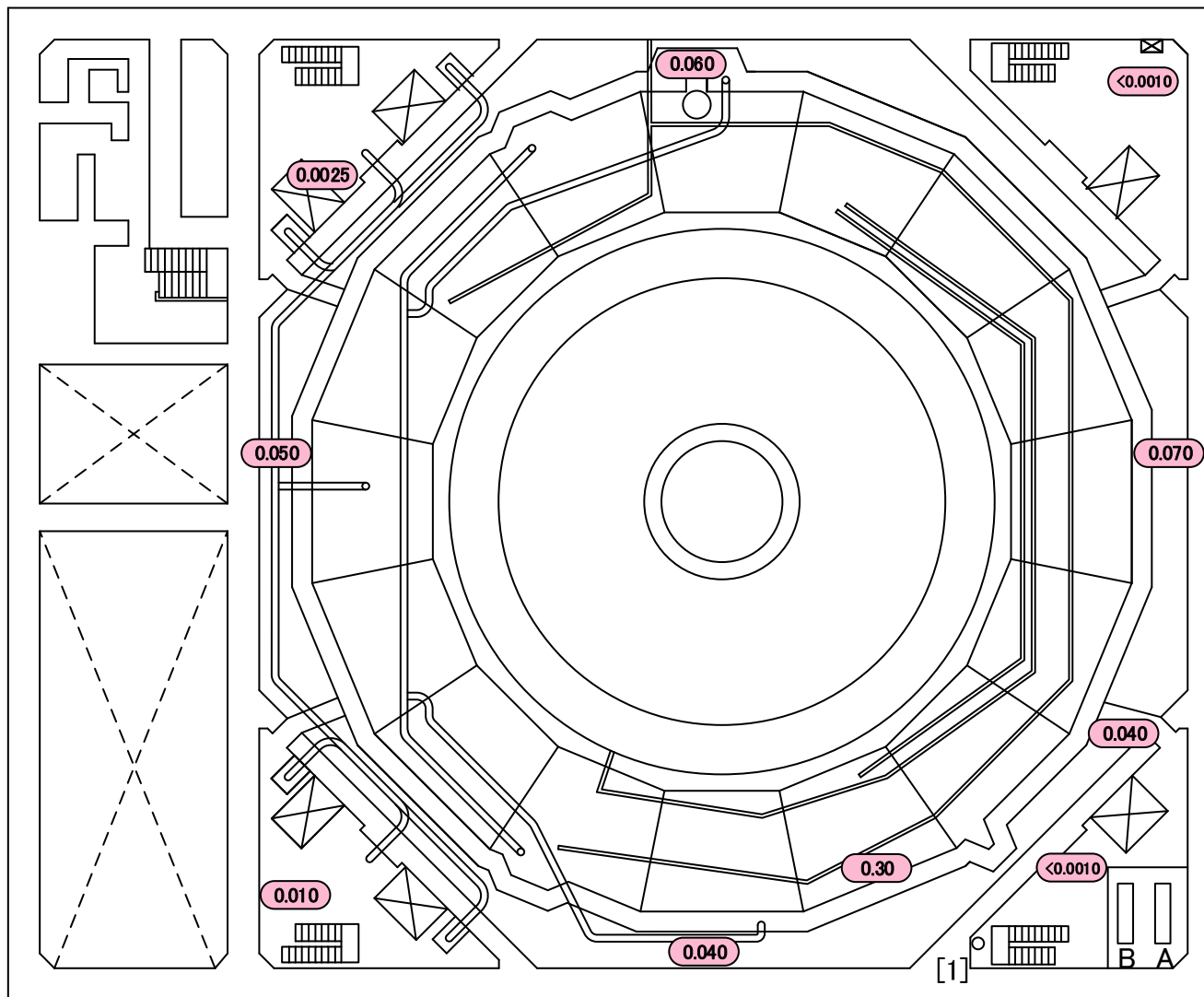

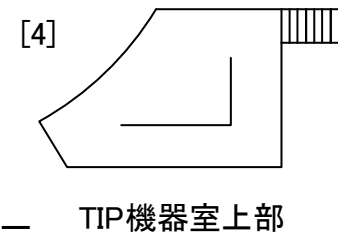
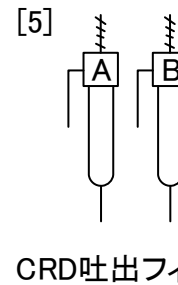
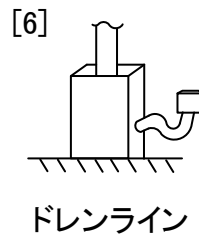
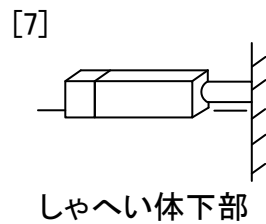
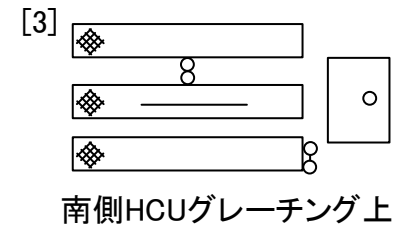
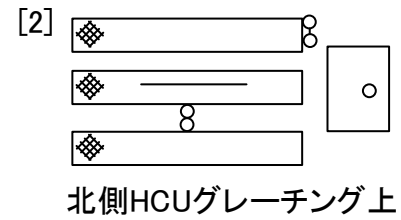
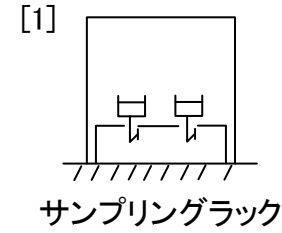
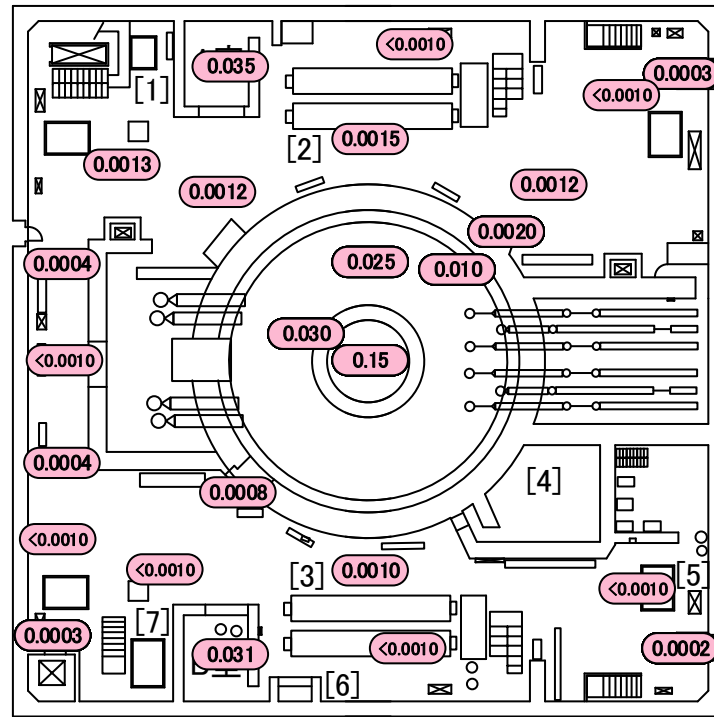

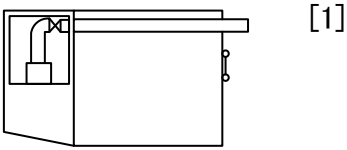
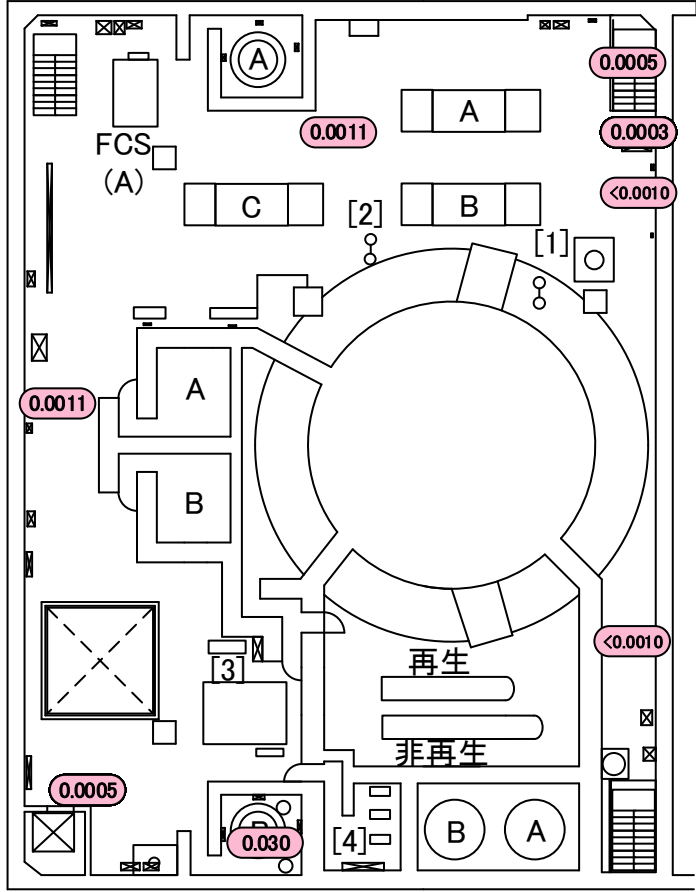

[1] 北東側グレーチング上

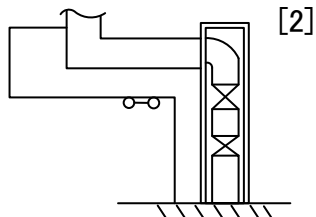

[2] 北側グレーチング上

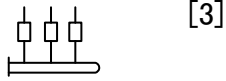

[3] 計装ラック下部

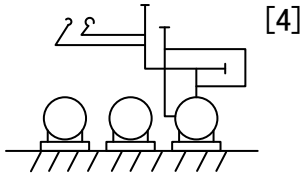

[4] スラッジ放出混合ポンプ

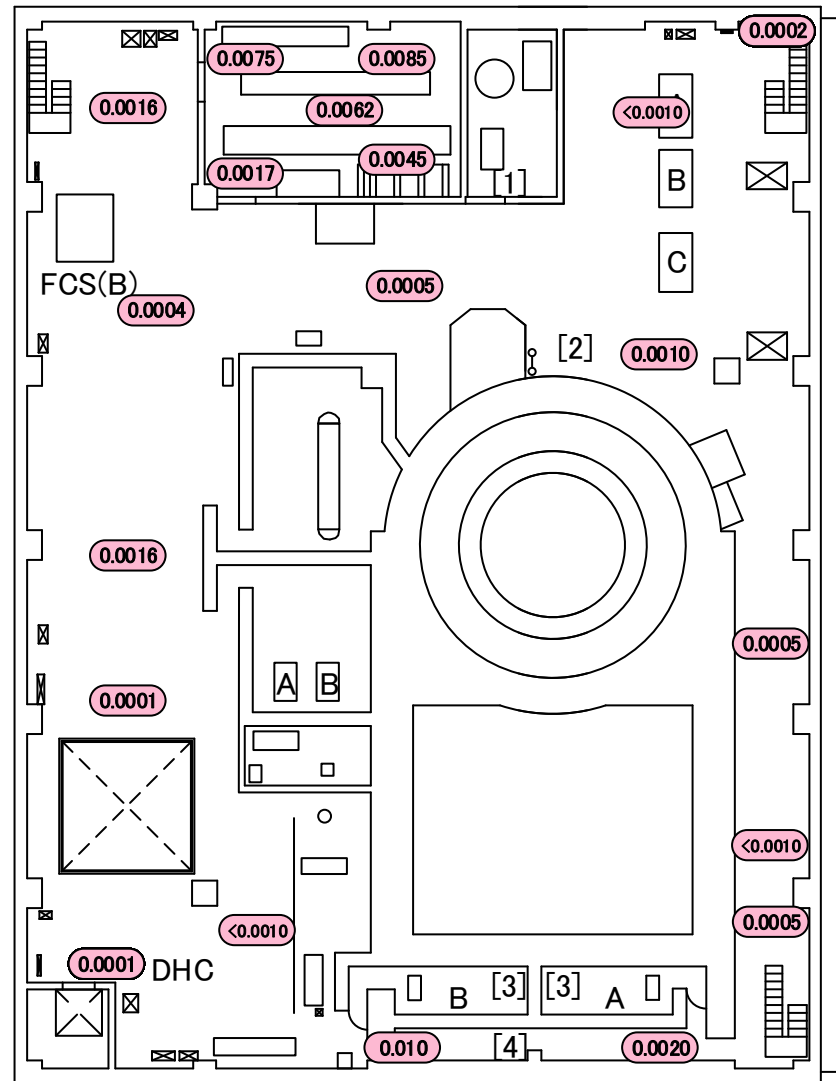
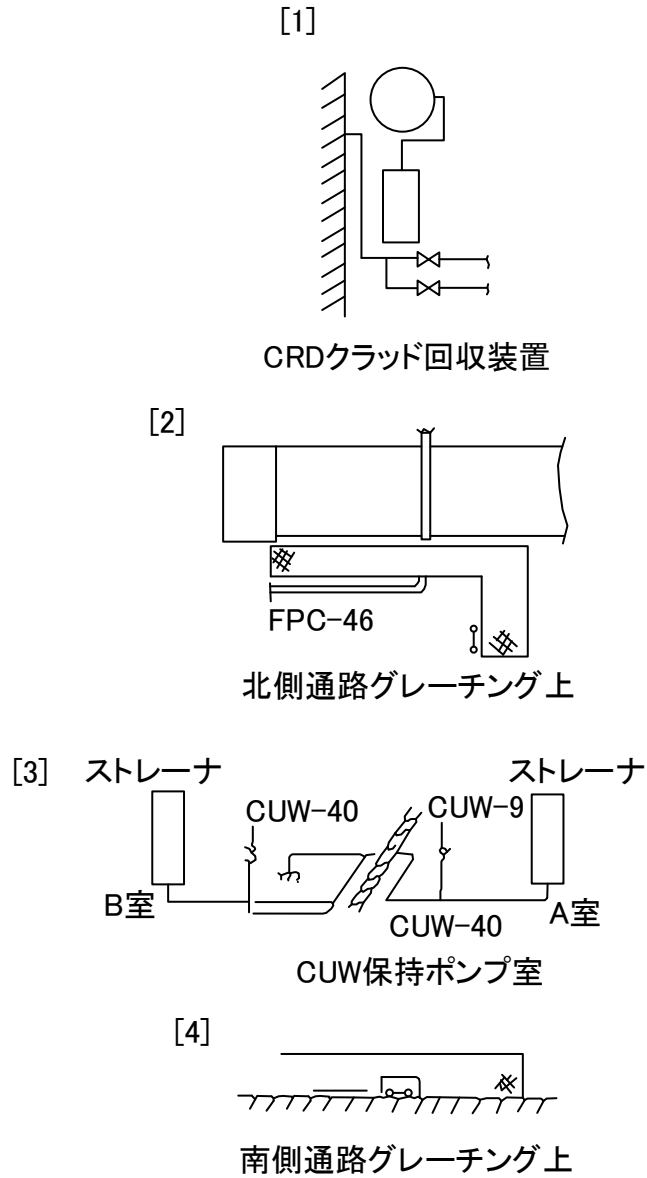

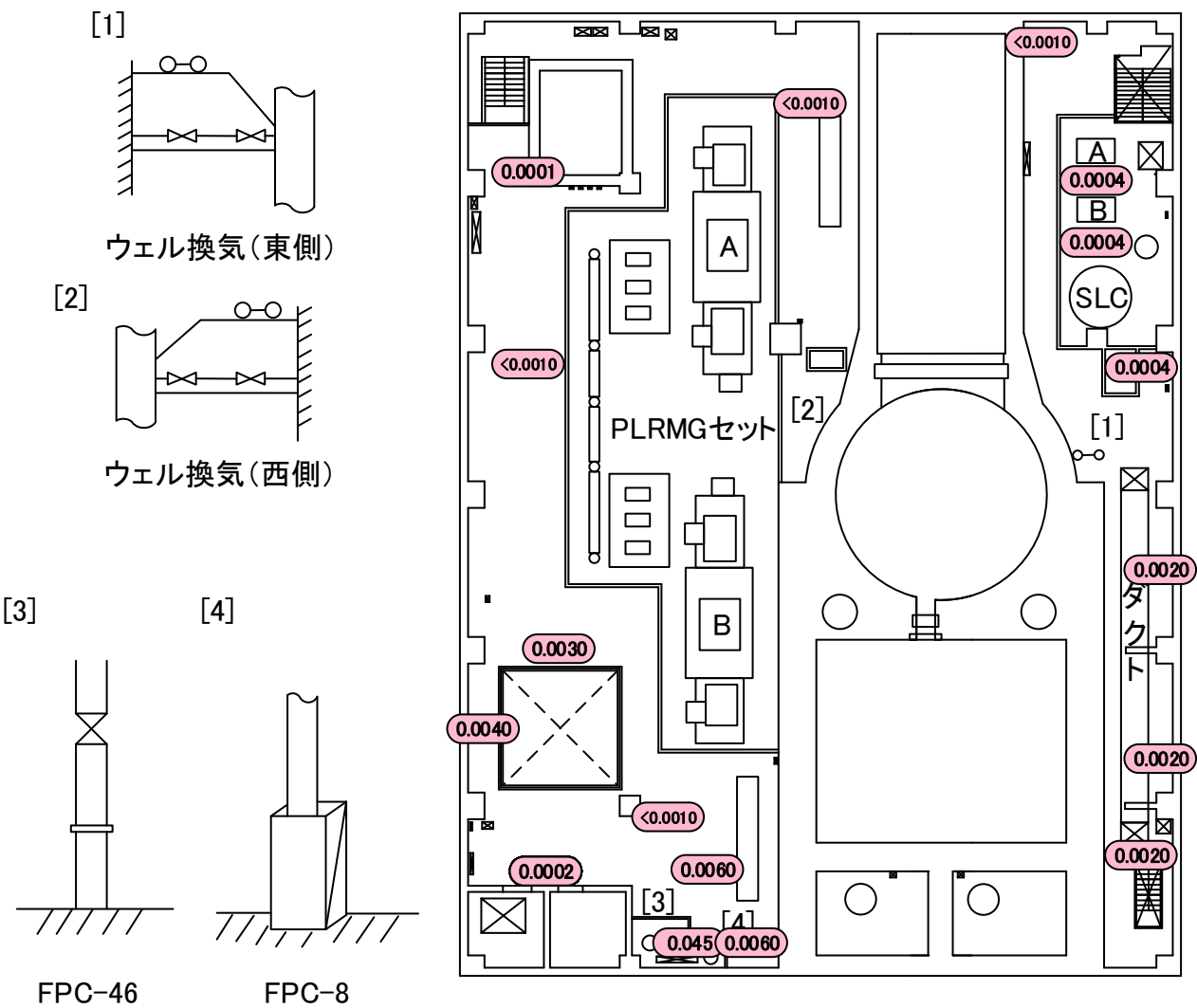

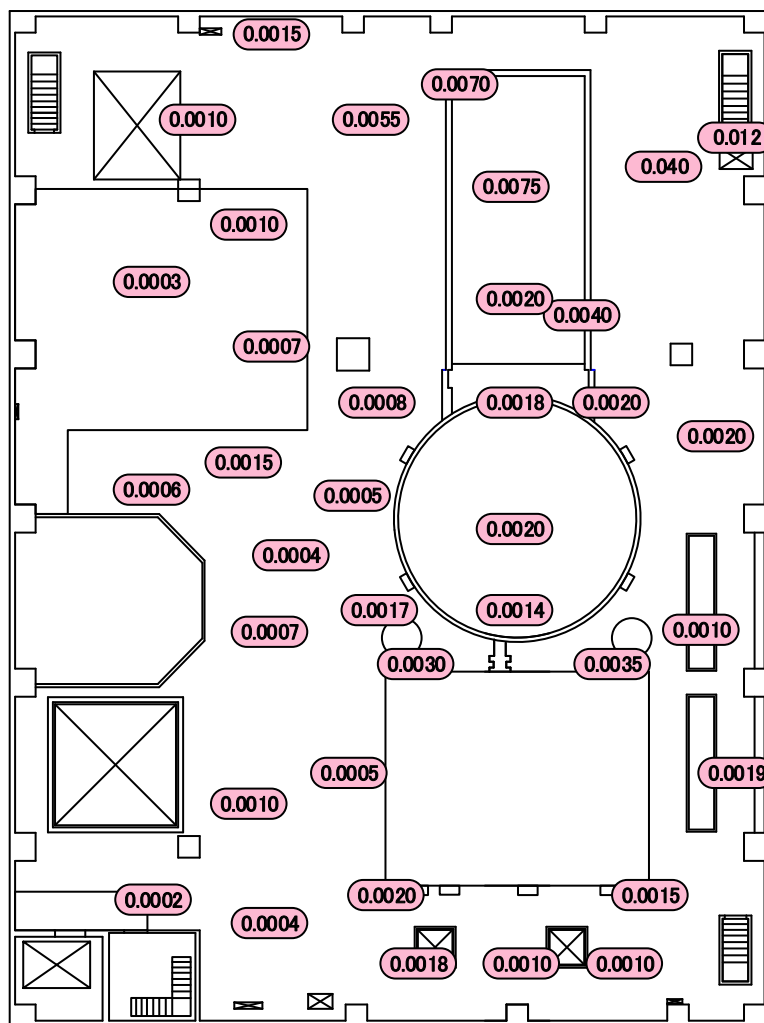

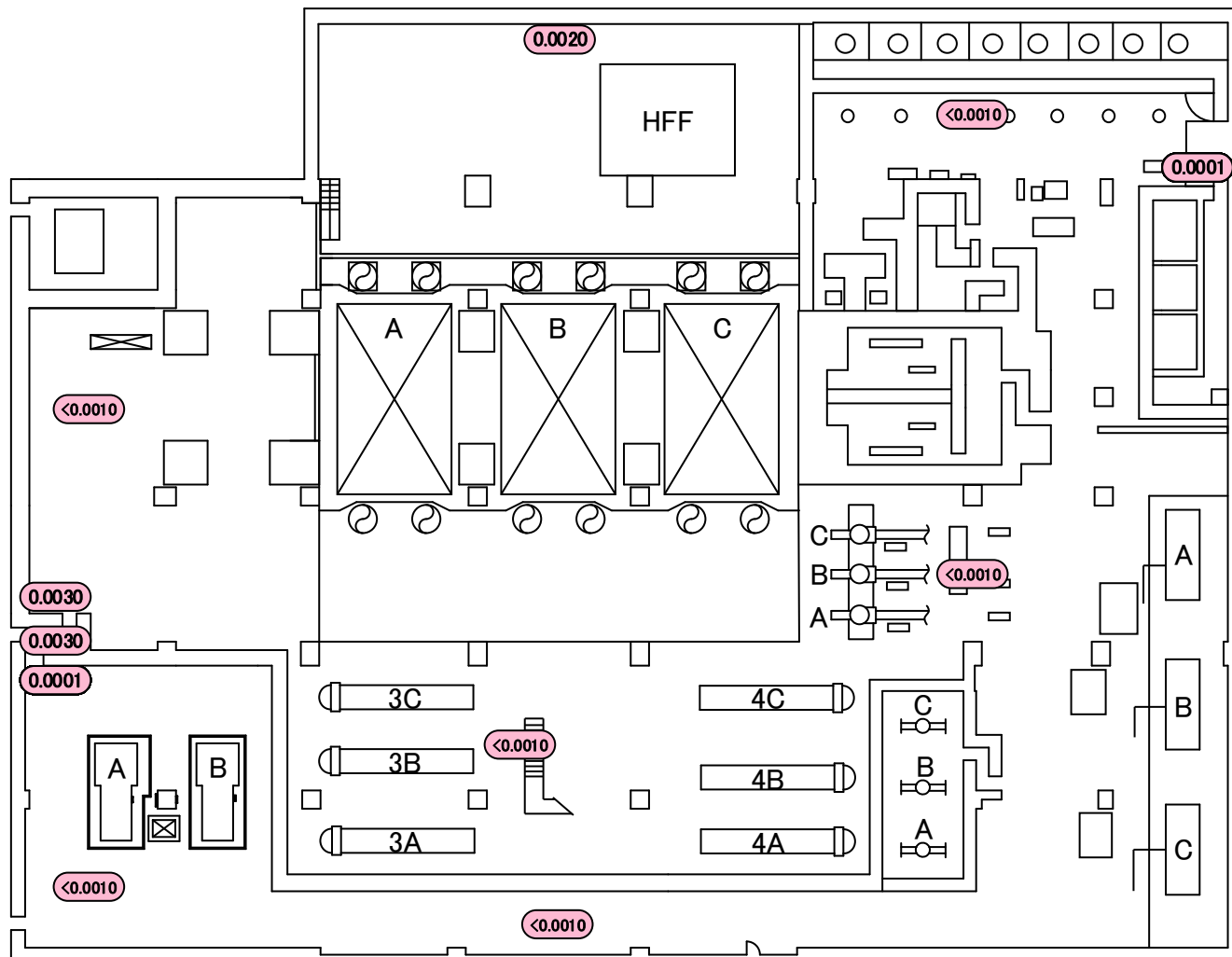

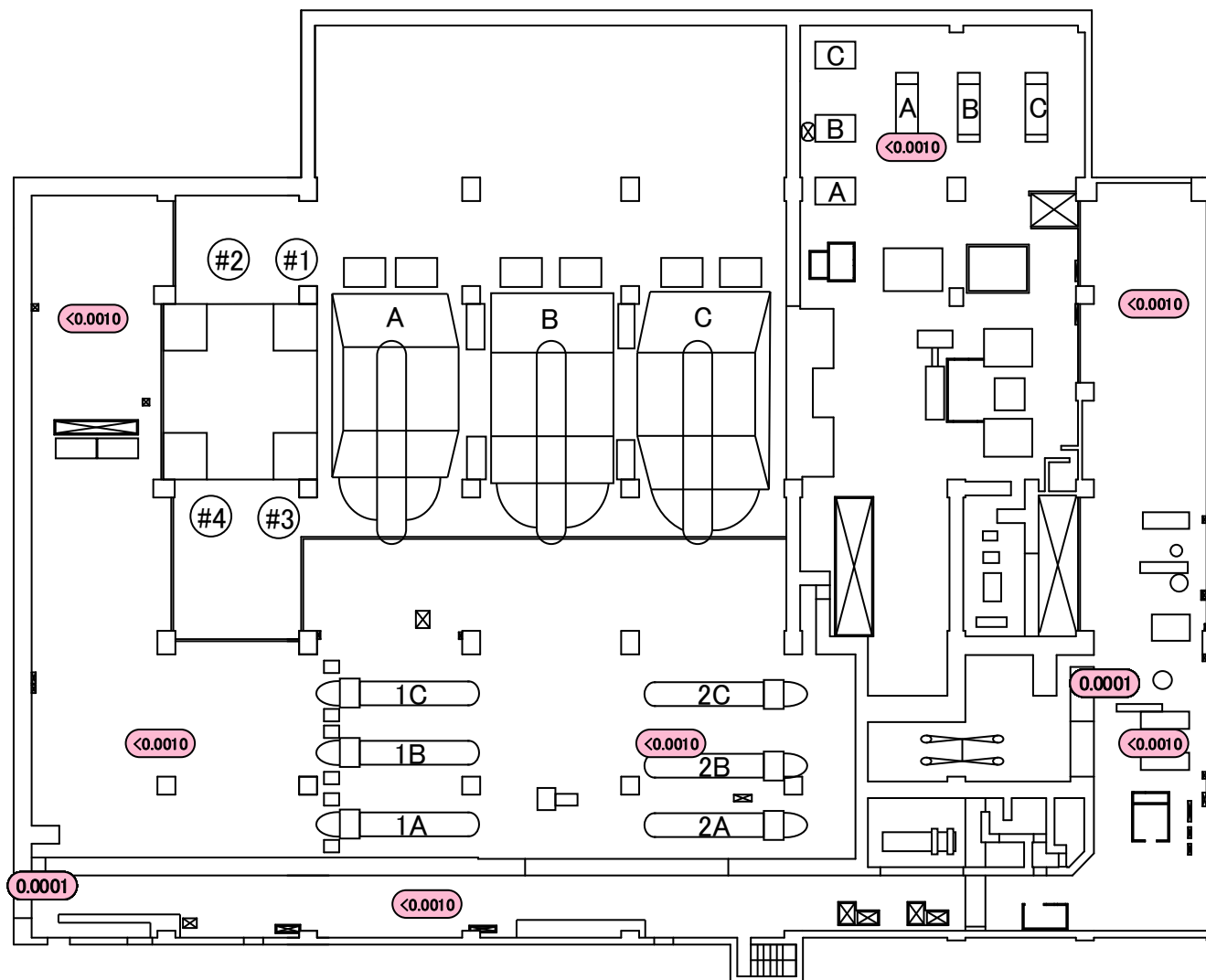

[1]
AS-23

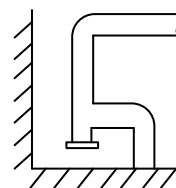

[2]
エバポレータ

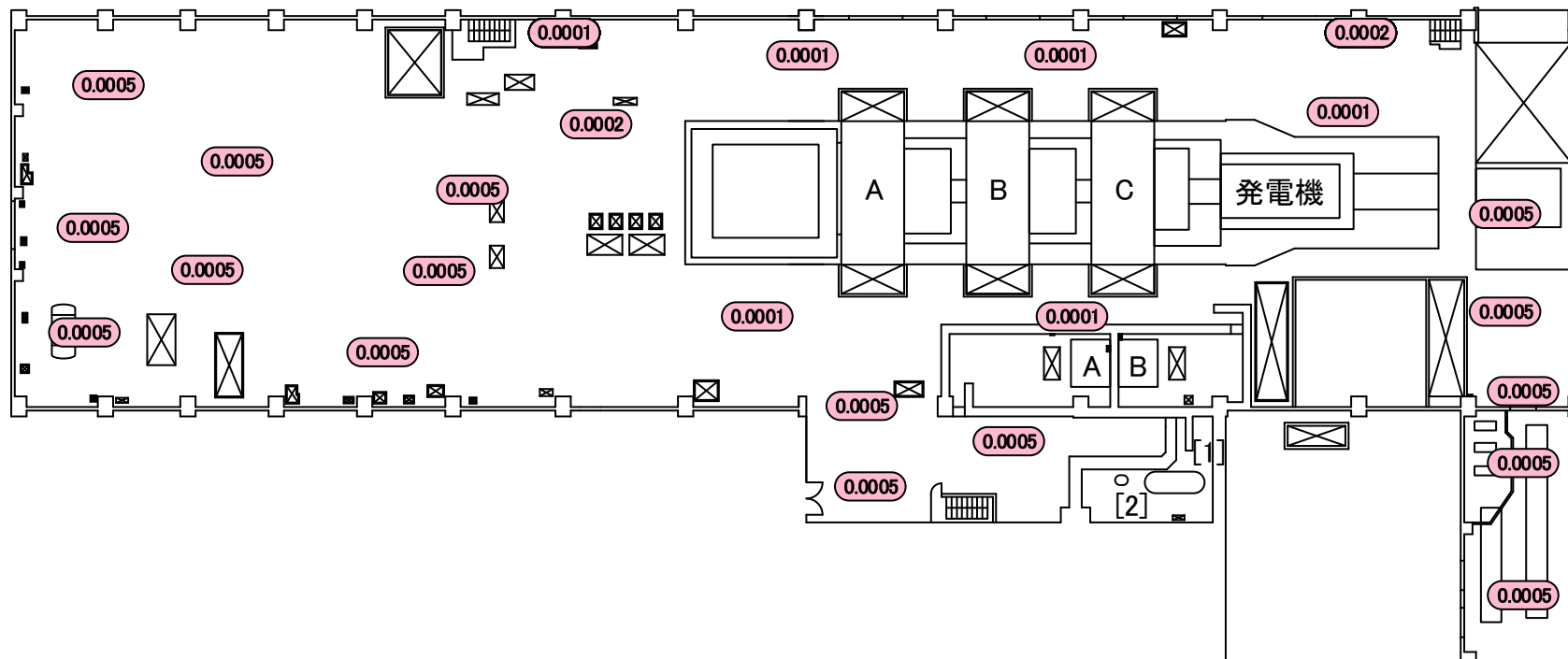
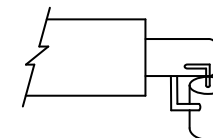

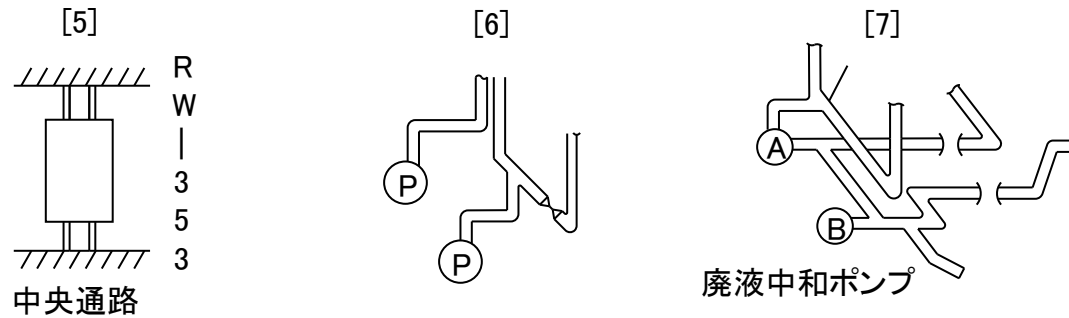
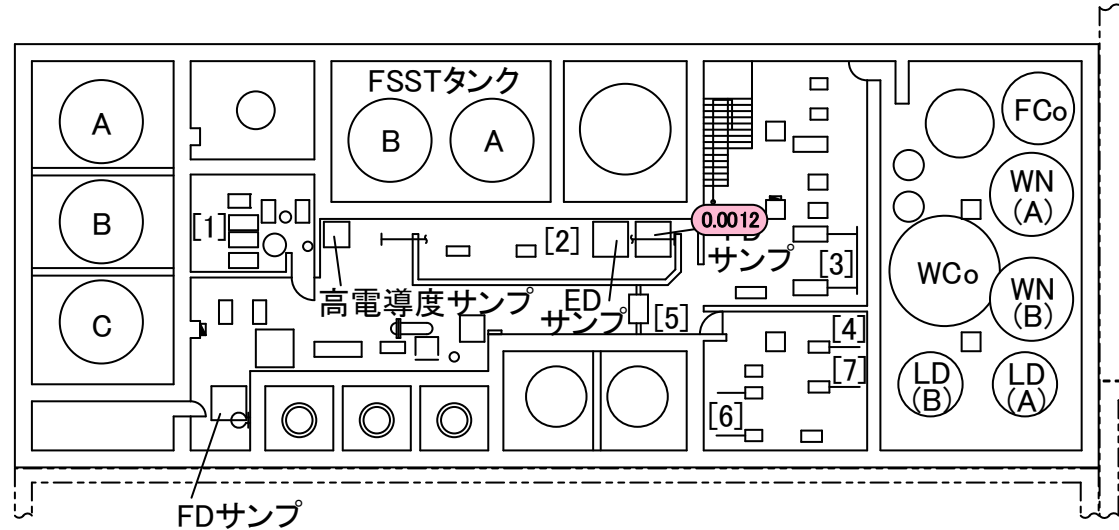
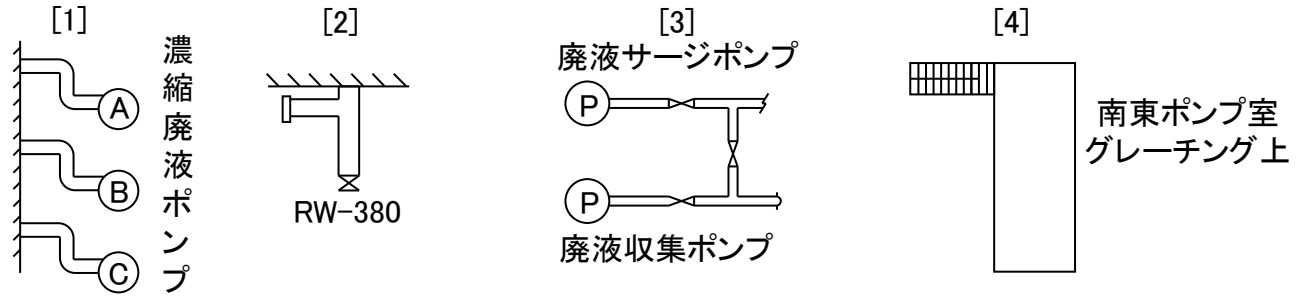

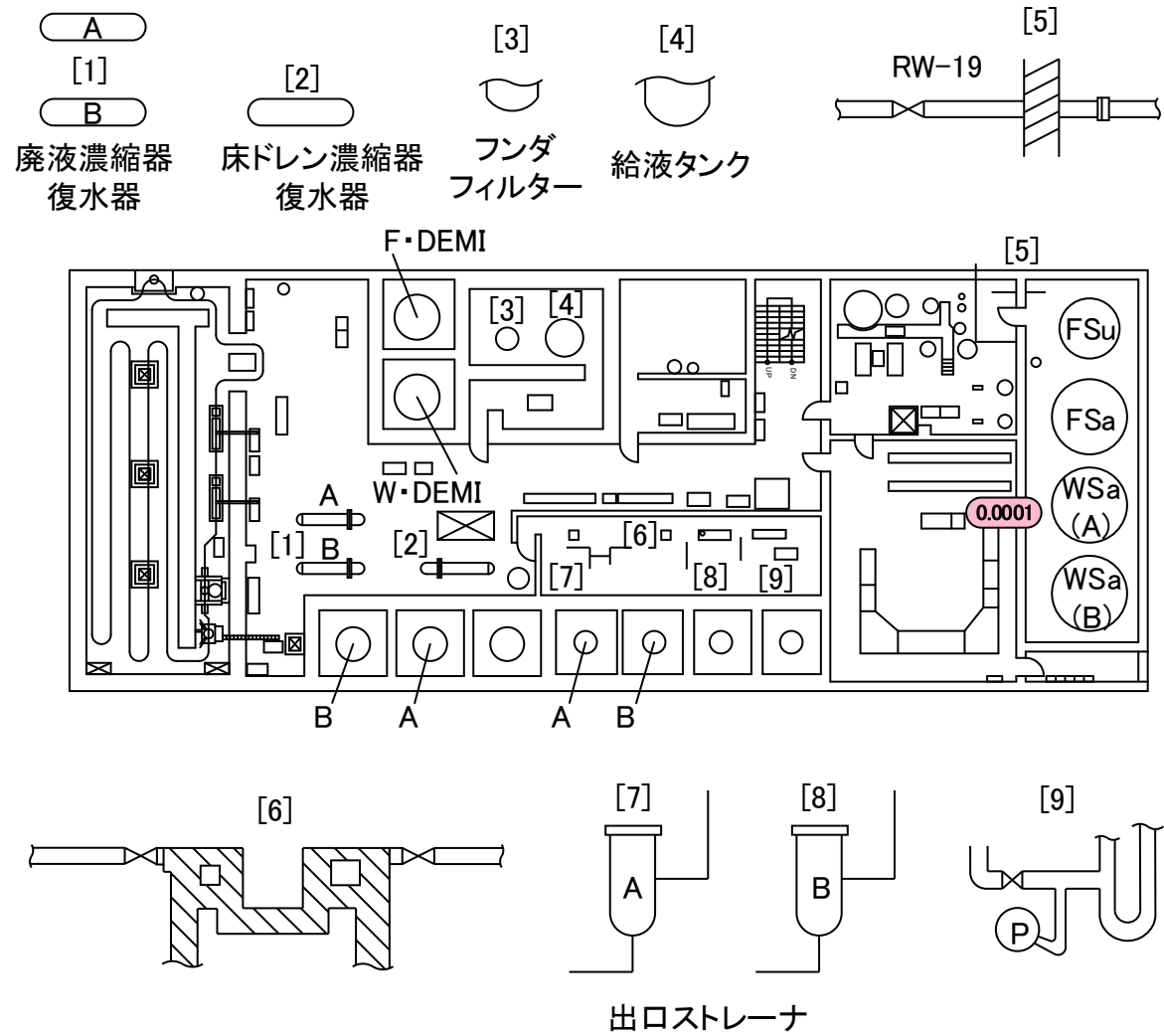

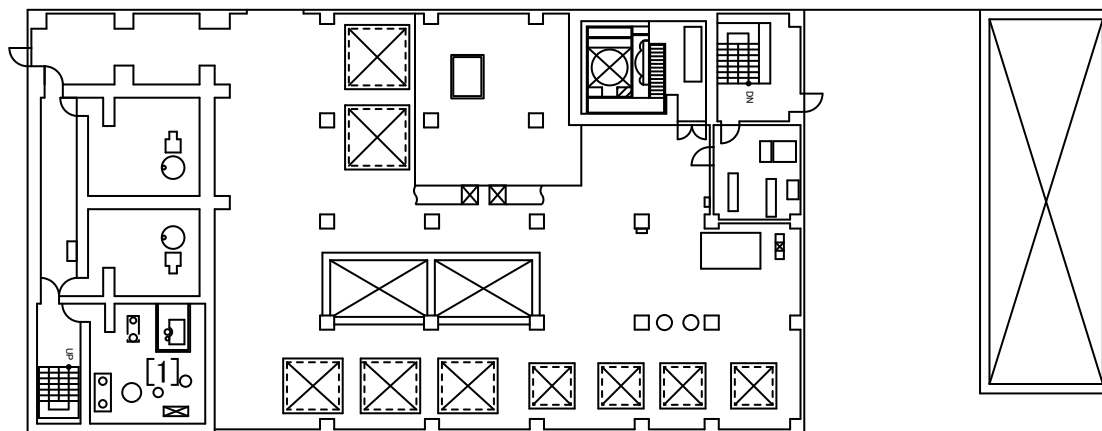

[1]



濃縮廃液計量タンク

福島第一 原子力発電所

図面名称:

5号機 廃棄物処理建屋 3階

[単位: mSv/h]

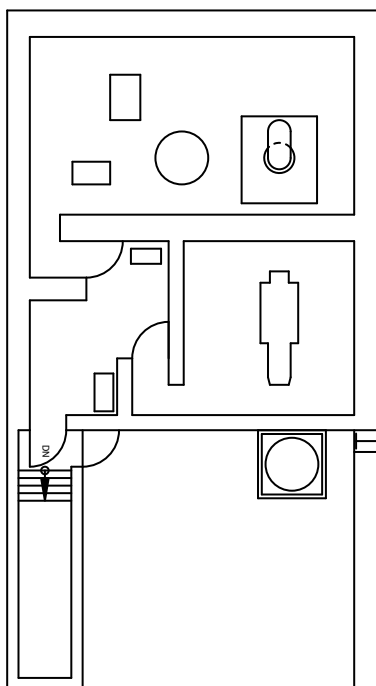

福島第一 原子力発電所

図面名称:

5・6号機 サービス建屋 2階

[単位: mSv/h]

