

2018年3月30日  
東京電力ホールディングス株式会社  
福島第一廃炉推進カンパニー

# 建屋内の空間線量率について

データ採取期間

- ・ 6号機 : 2018年1月1日～2018年1月31日

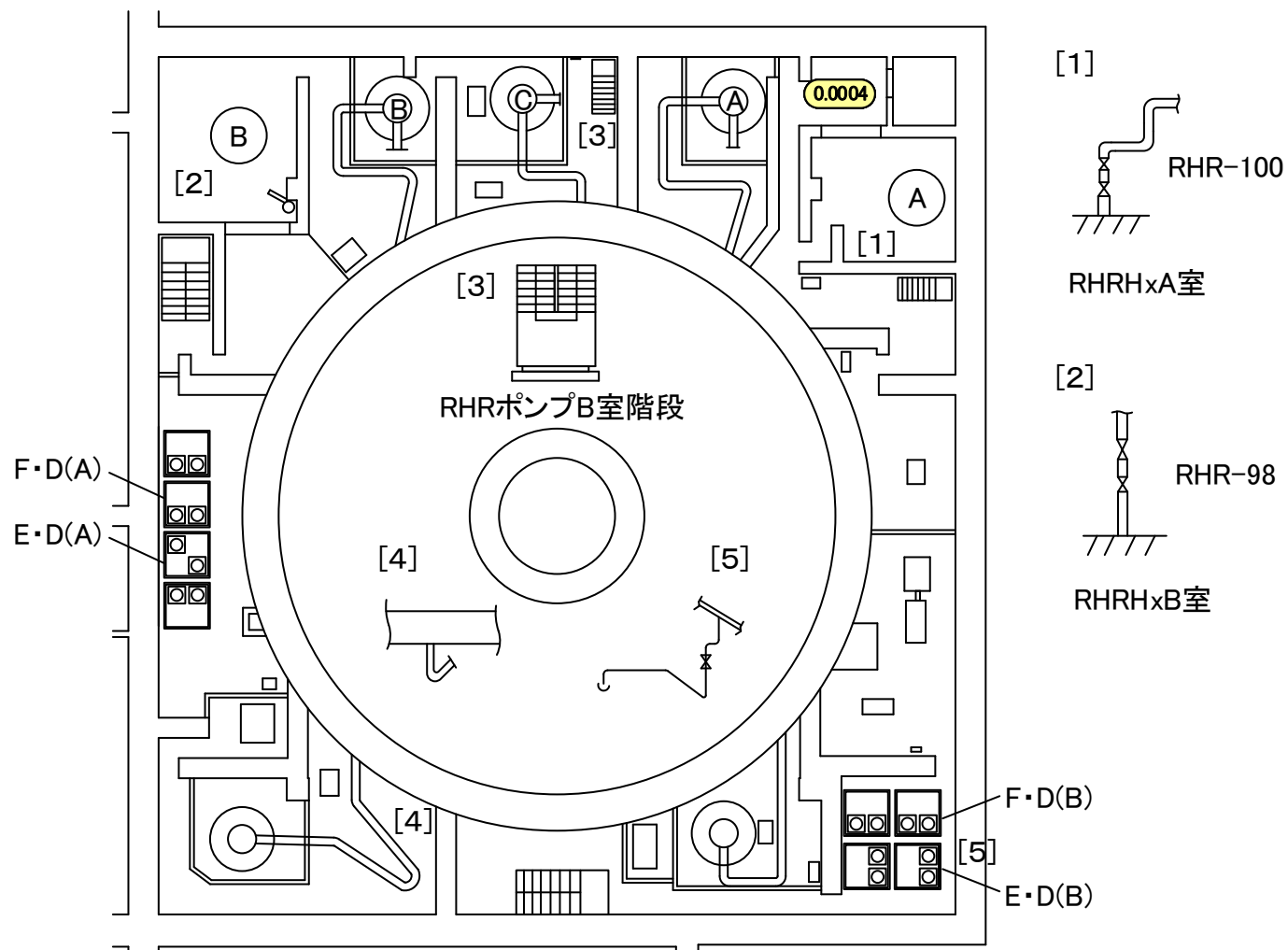

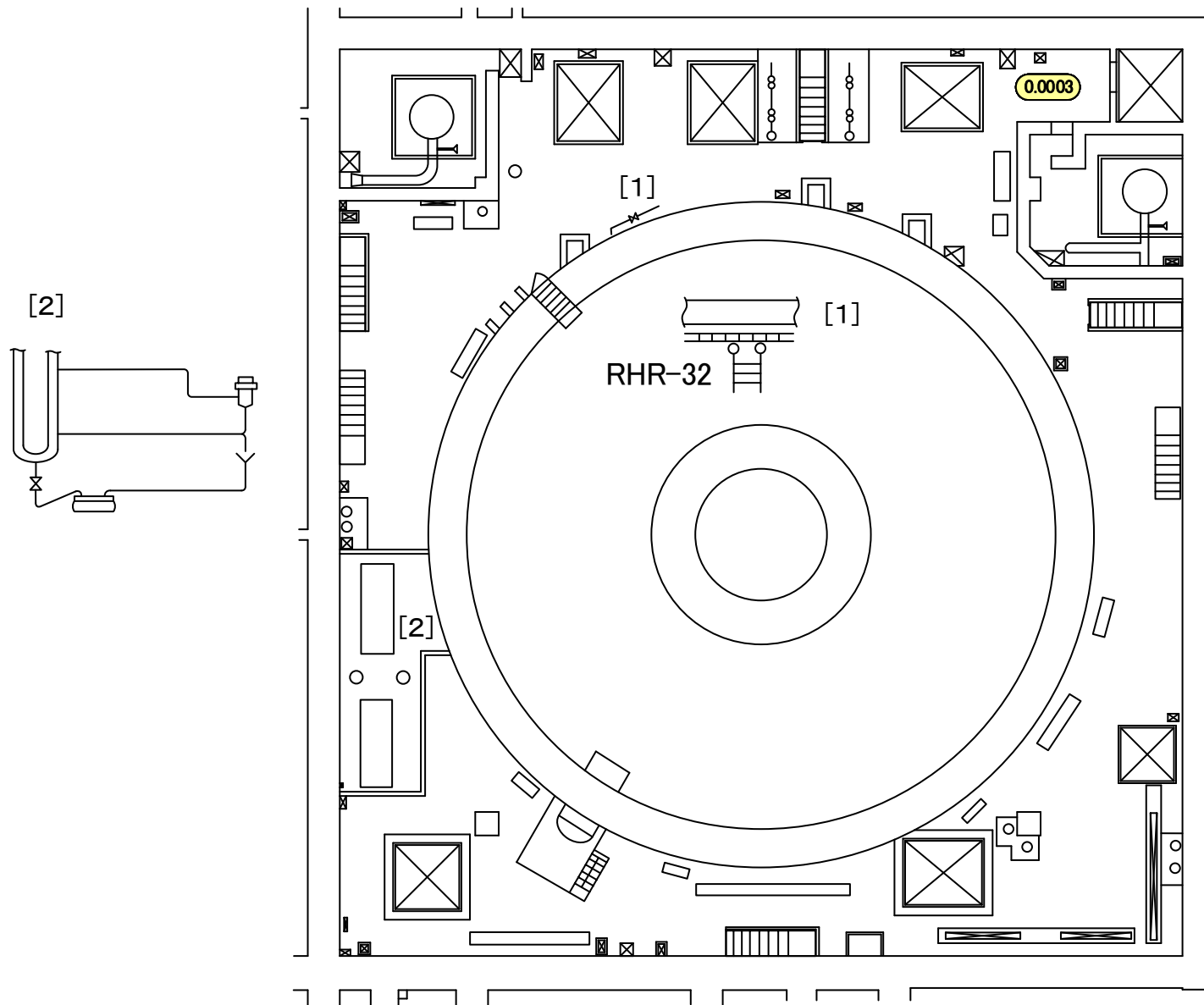

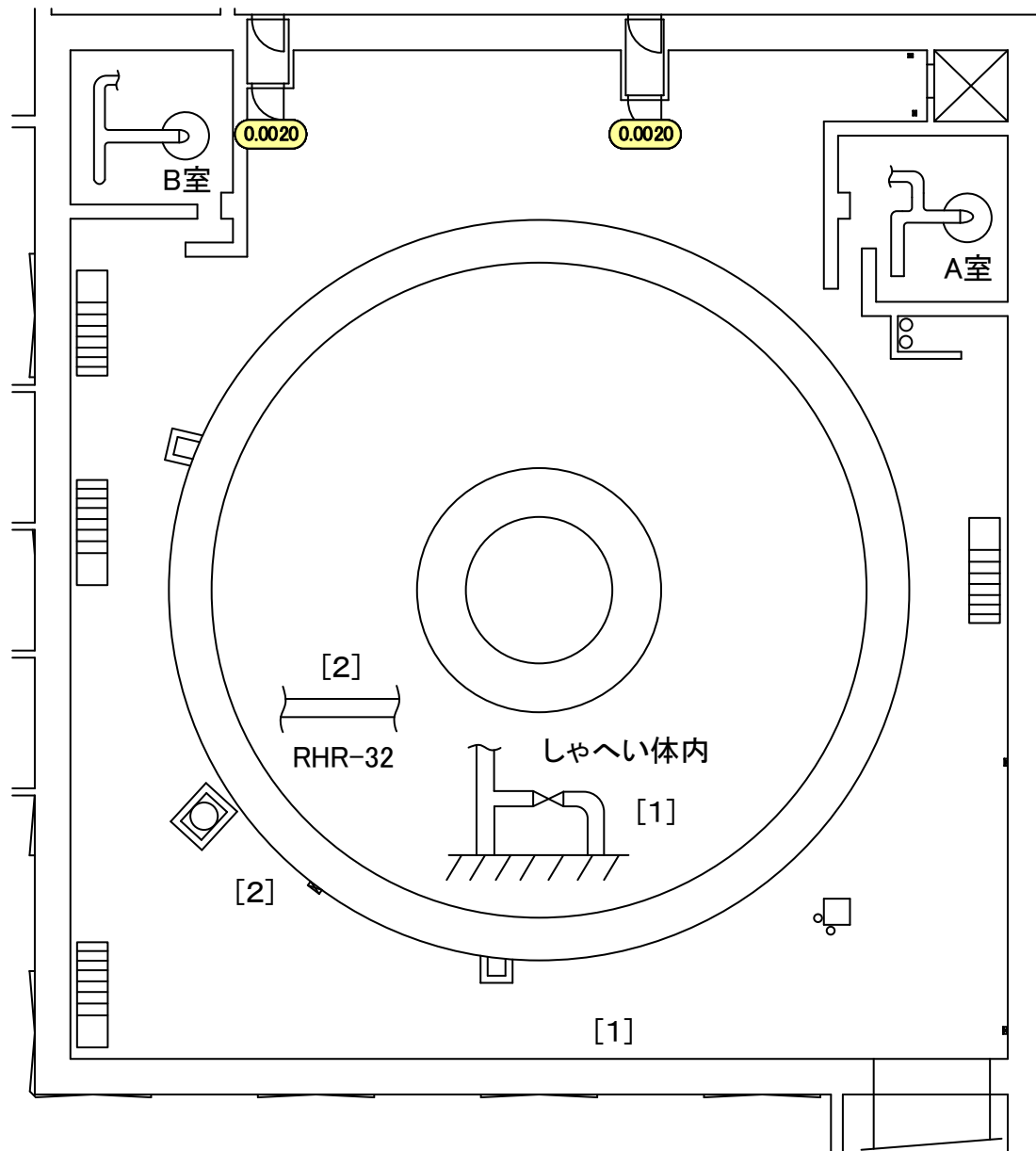

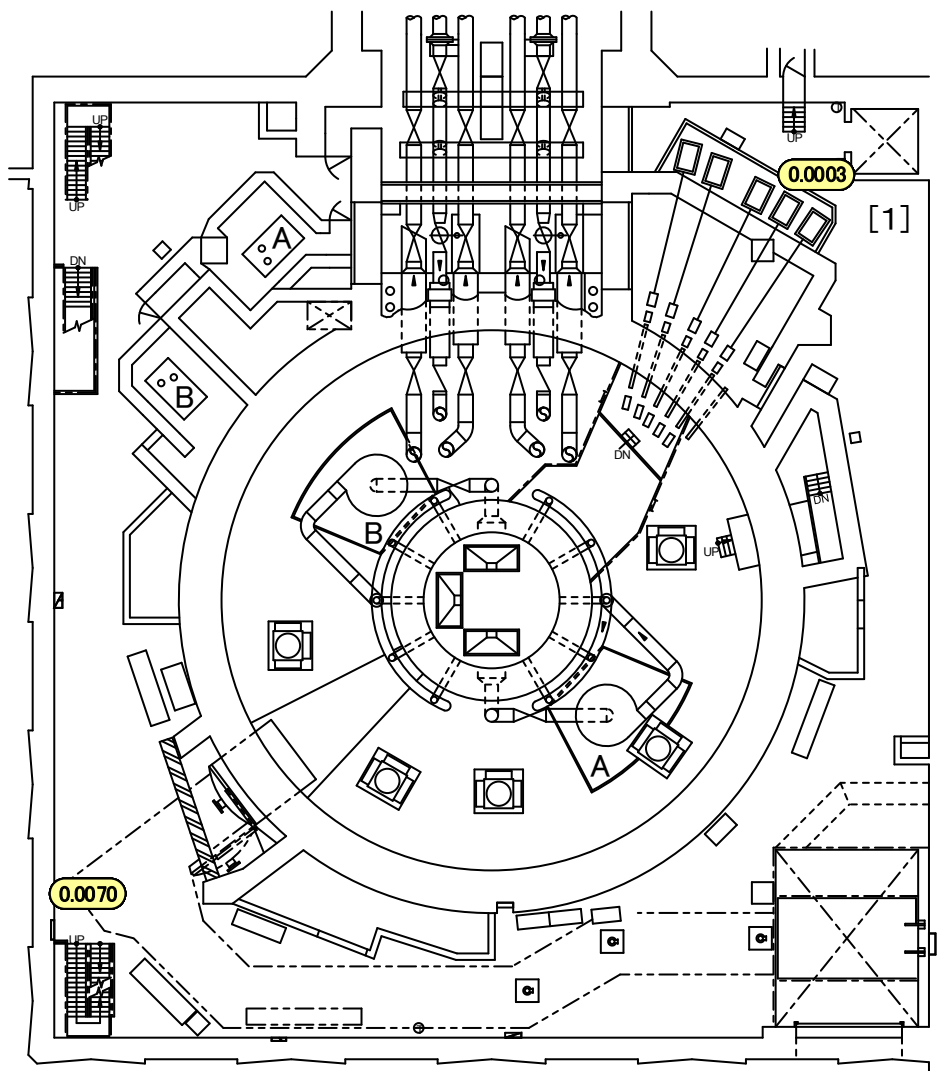

[1]

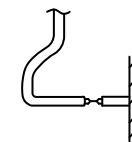

FPC-49

[1]  
サンプリング  
ラック

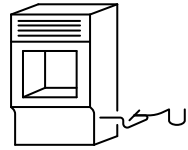

[2]  
グレーチング  
上

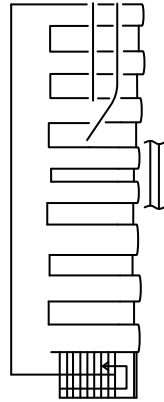

[3]  
CRD吐出  
フィルター

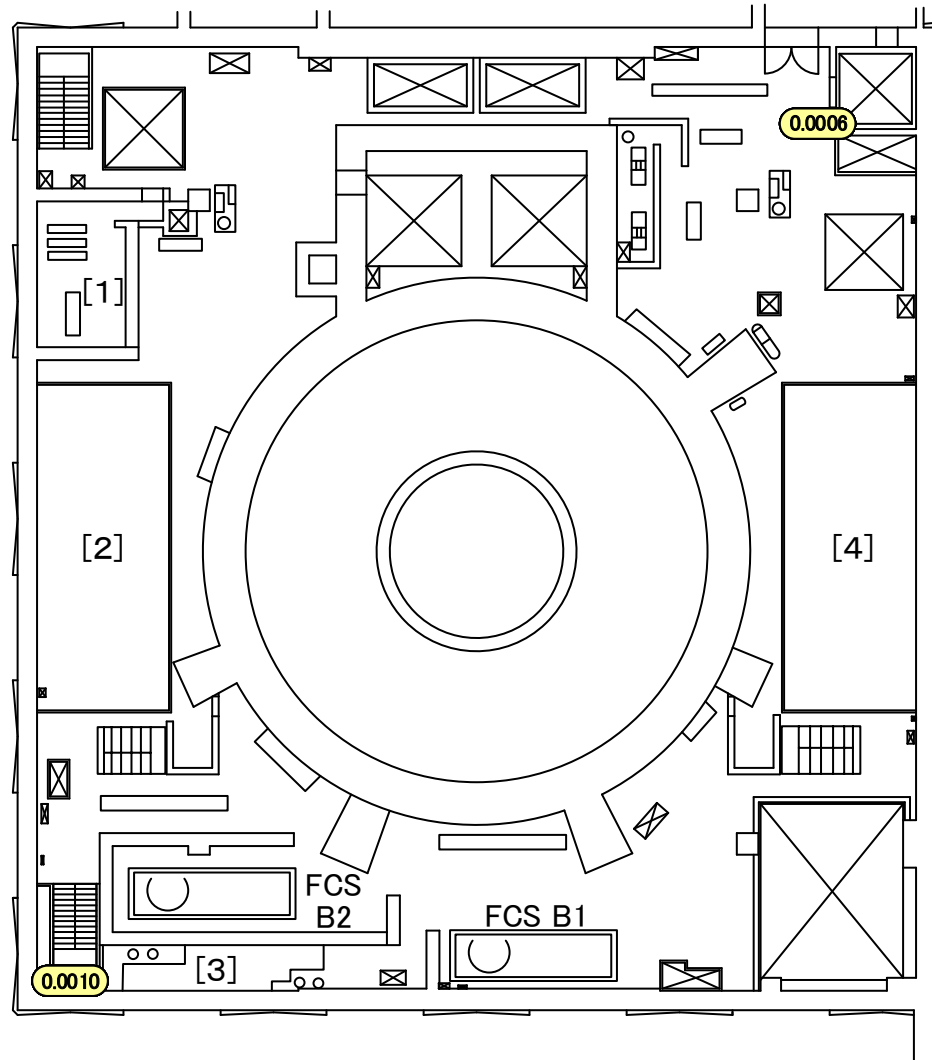
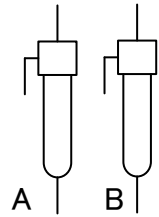

[4]  
グレーチング  
上

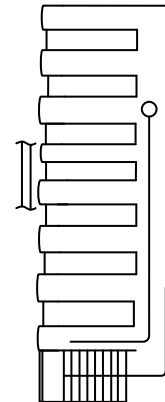

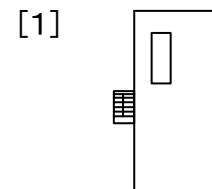
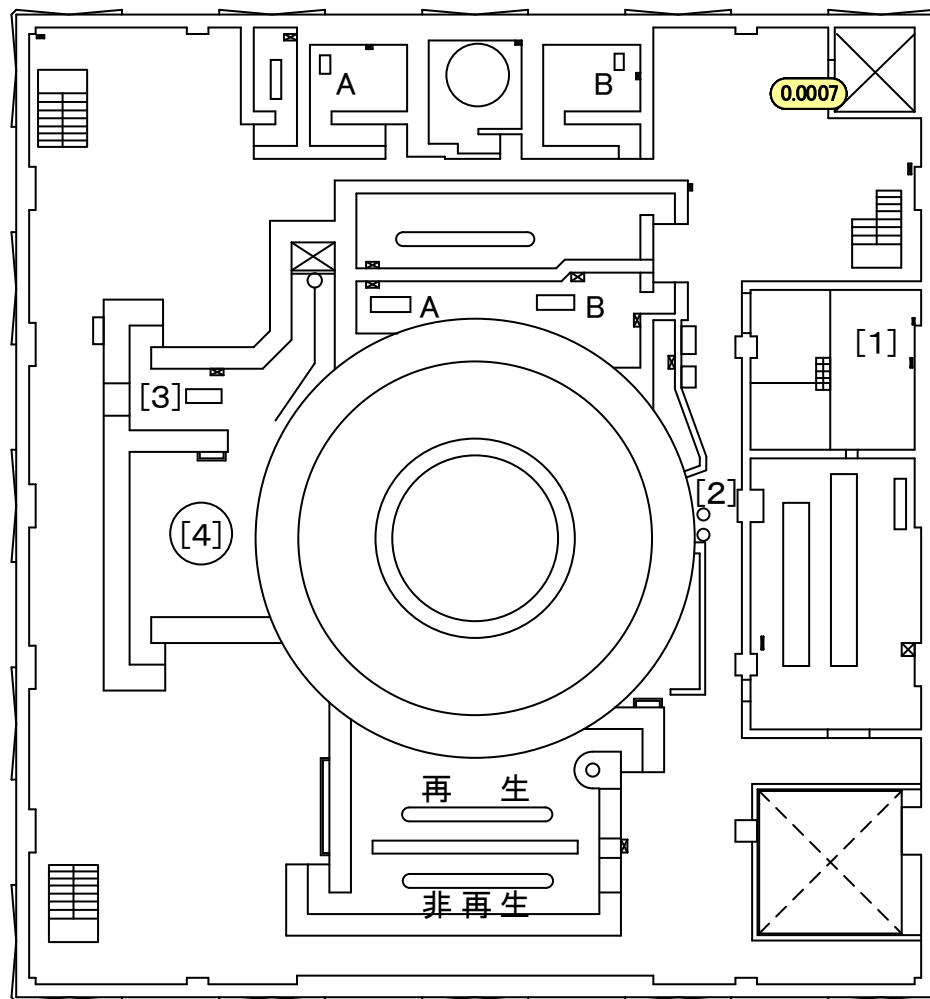

[1]  
CRD半自動分解装置  
操作エリア

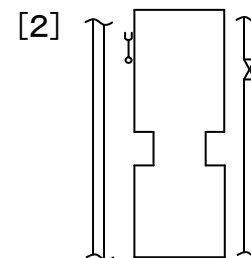

[2]  
南側通路  
グレーチング上

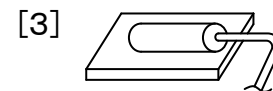

[3]  
CUW逆洗水移送ポンプ

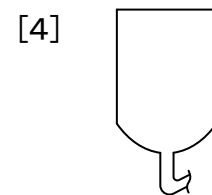

[4]  
CUW逆洗水受タンク

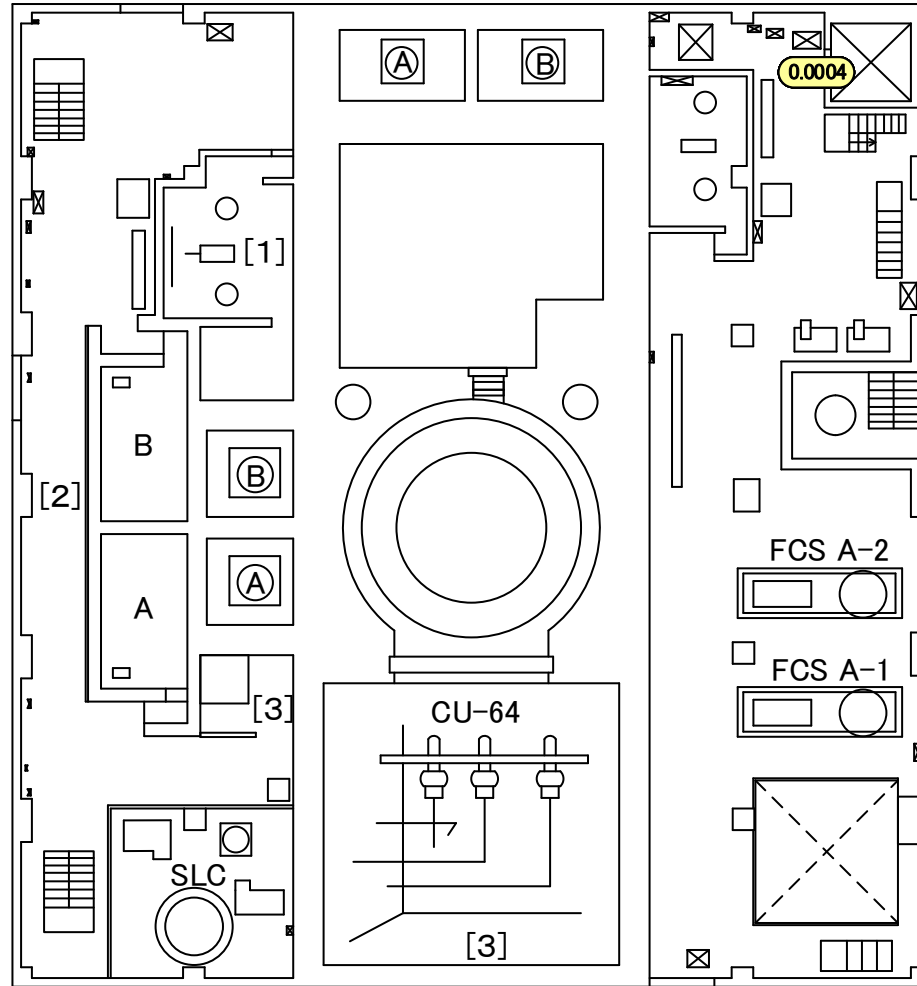
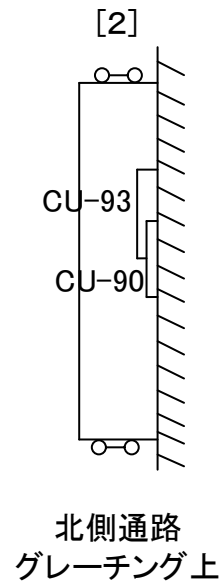
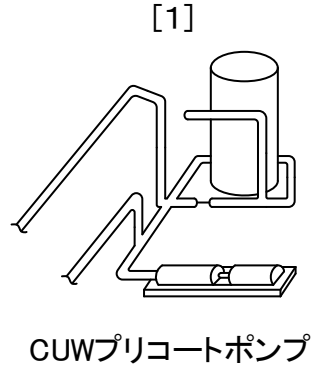



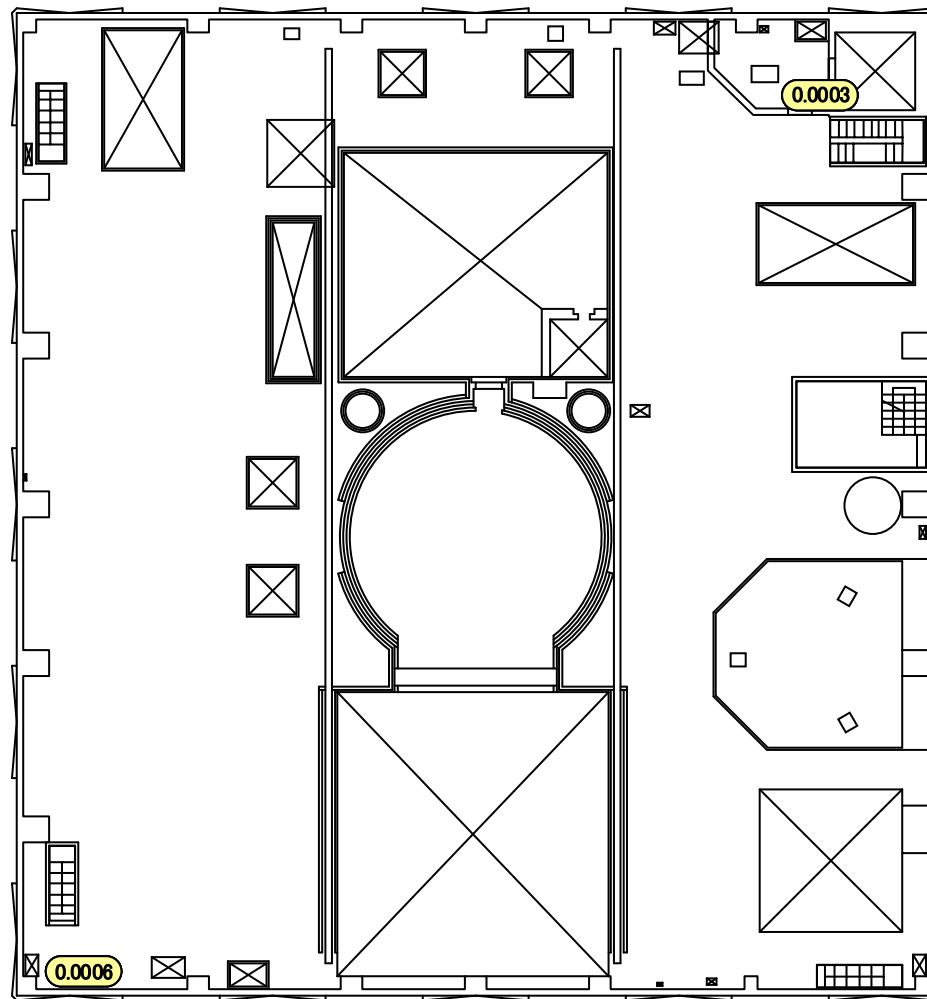

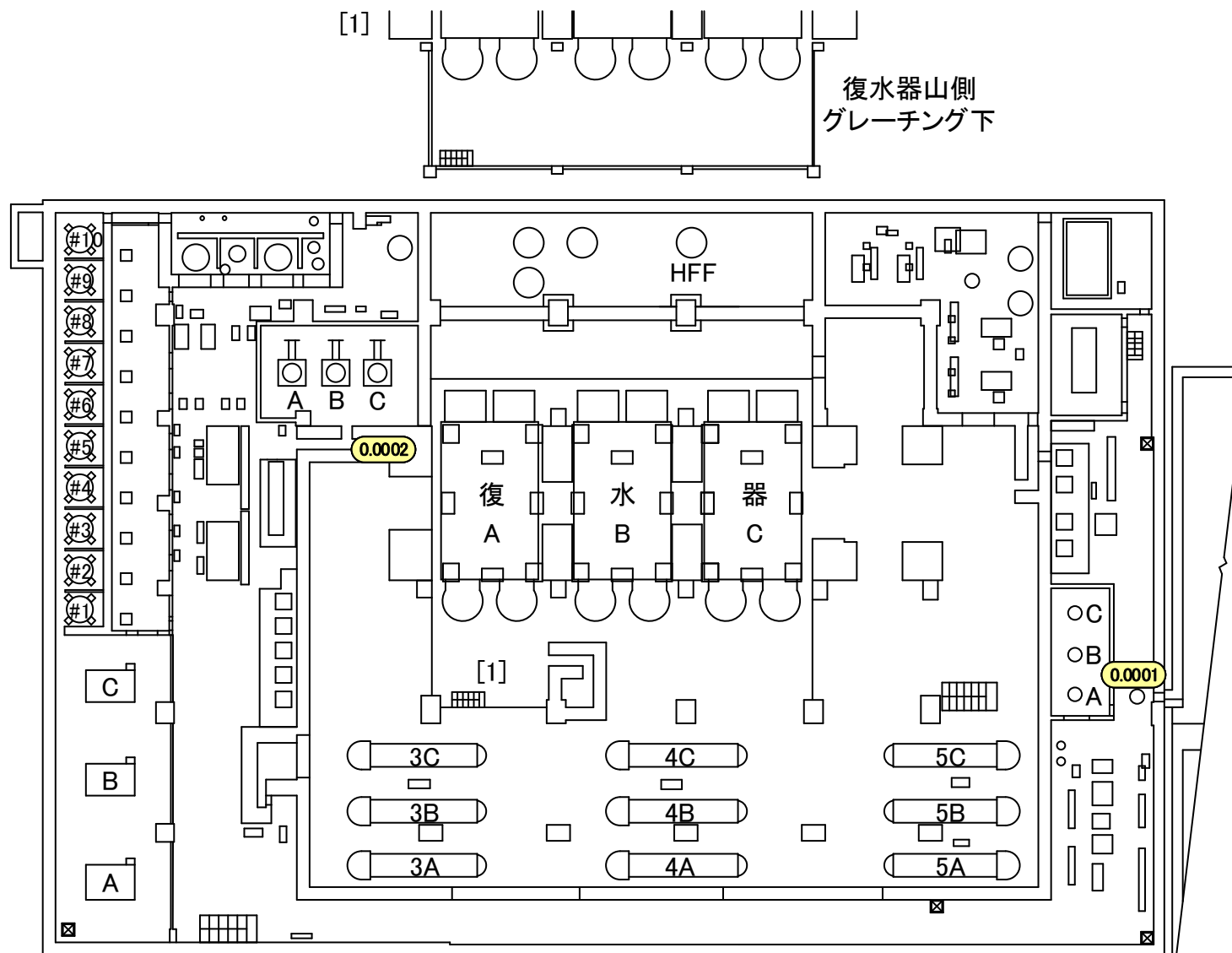

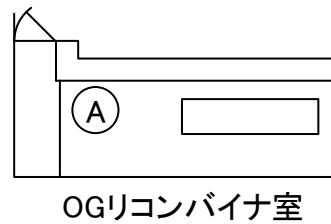
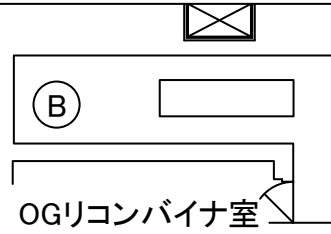
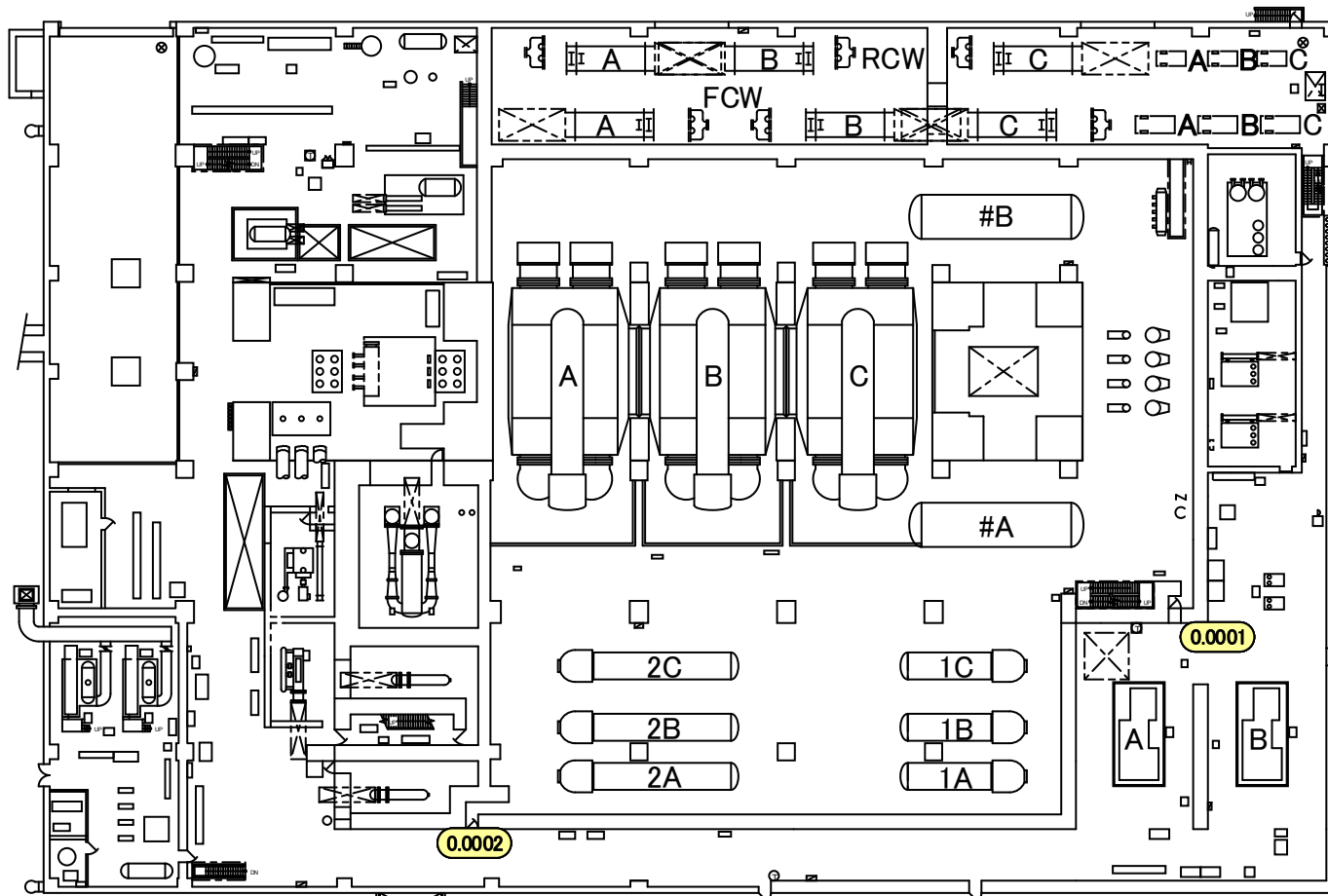

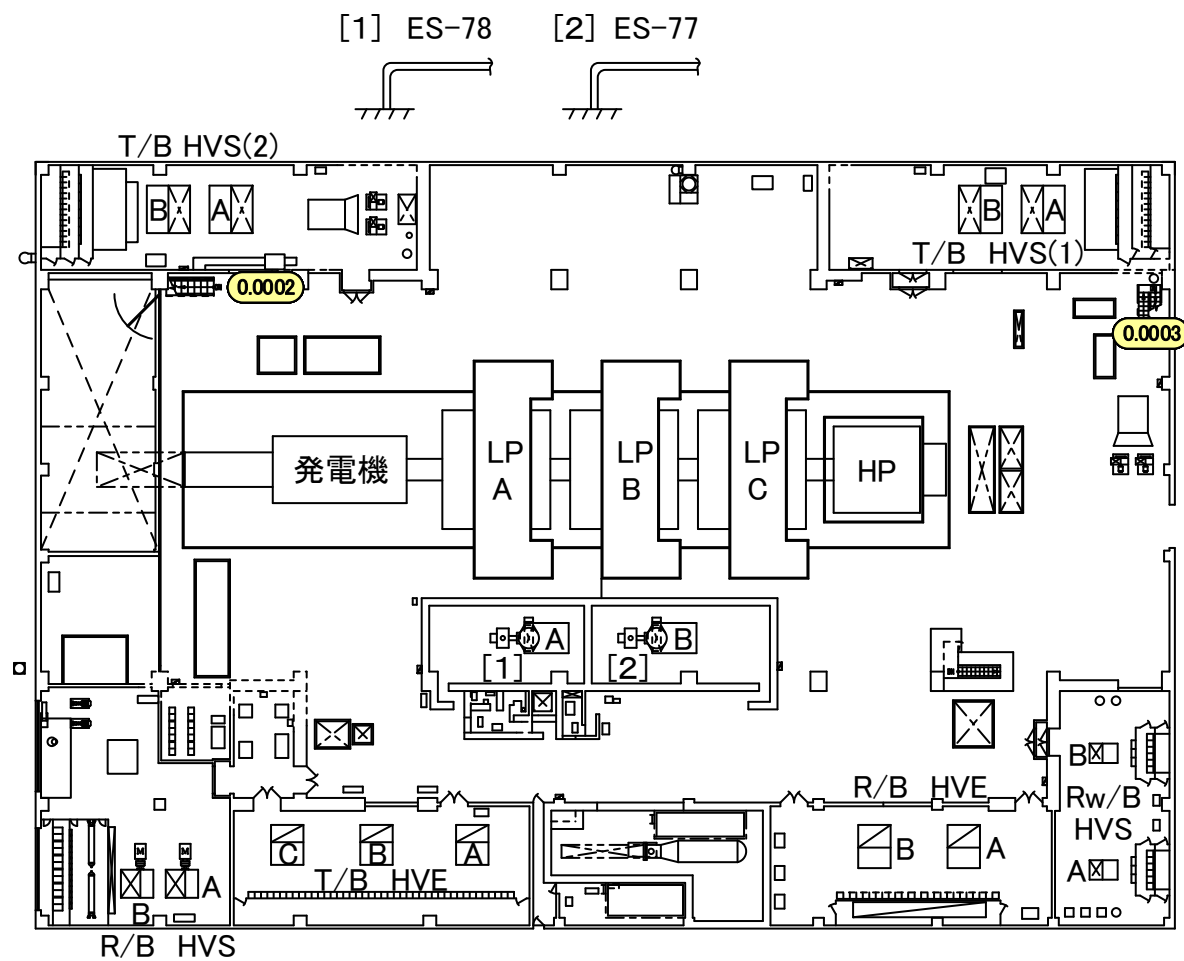

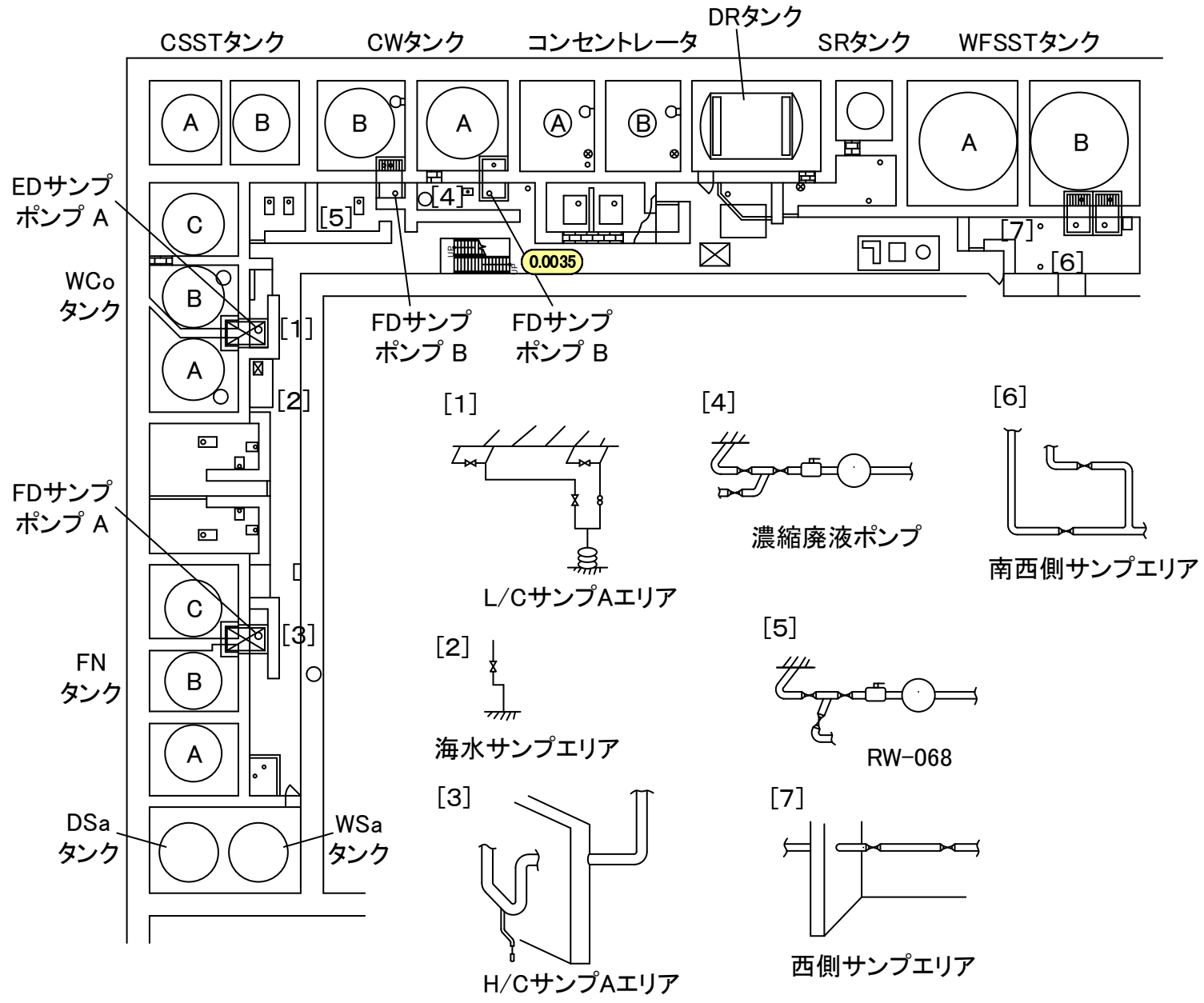

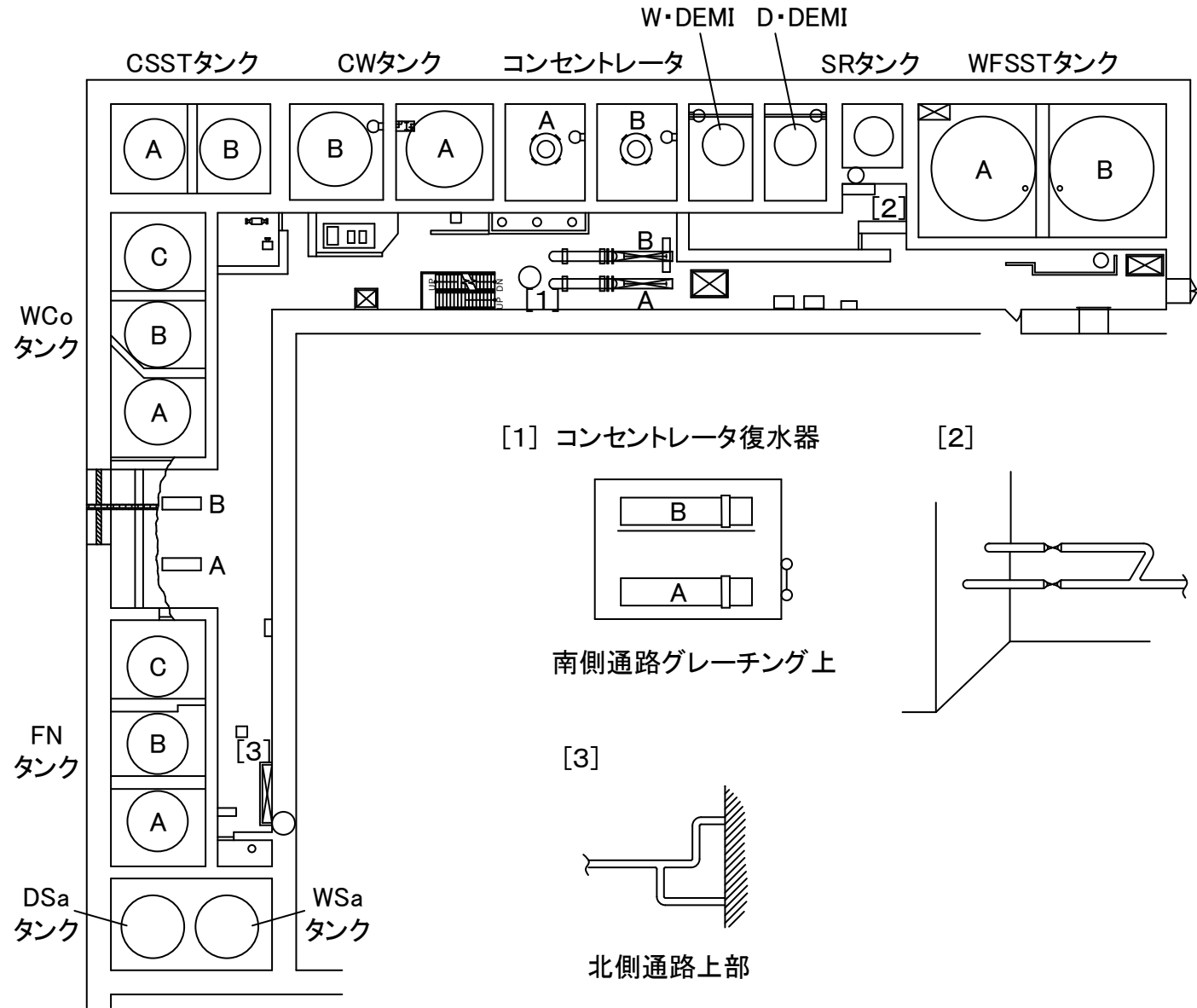

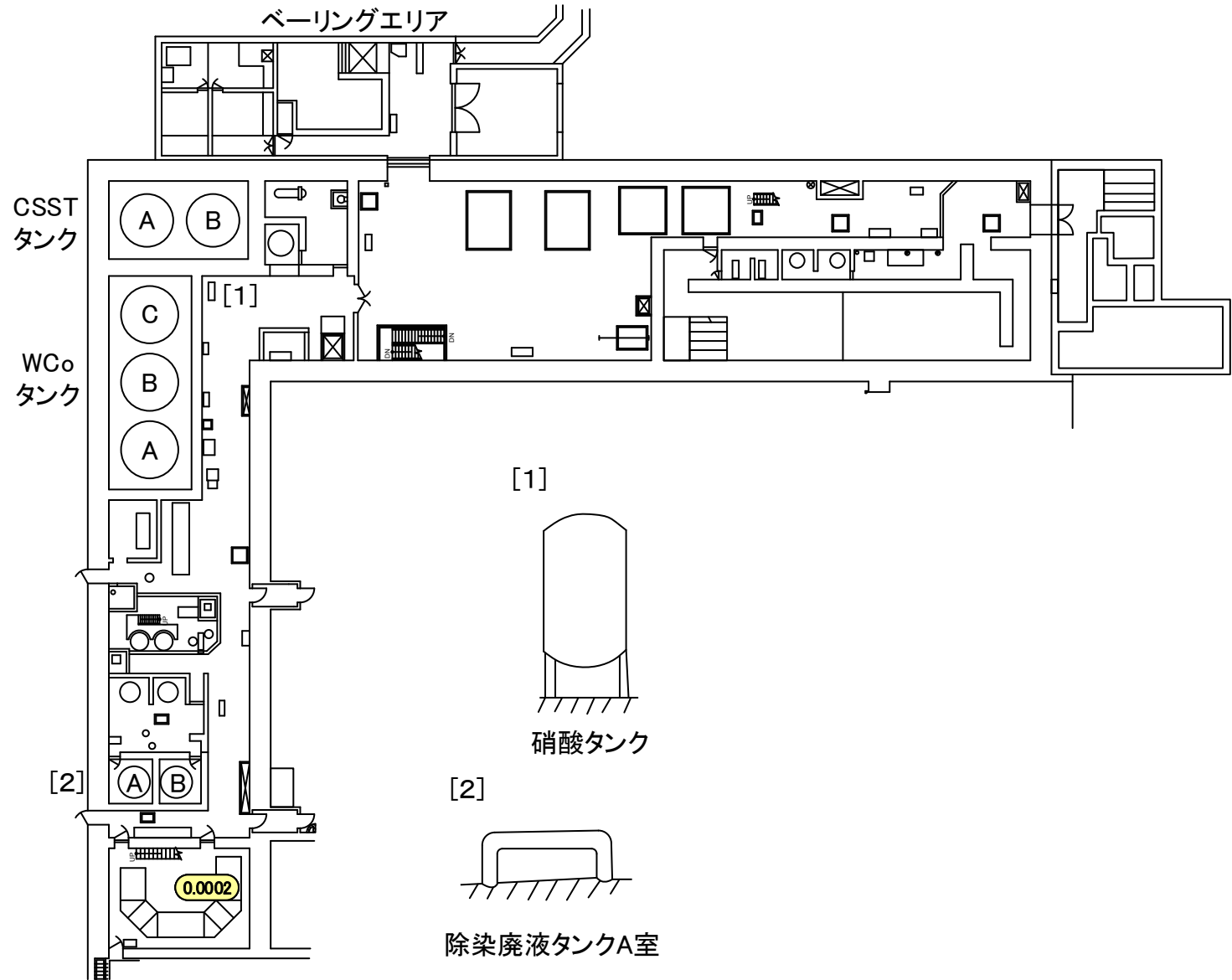

福島第一 原子力発電所

図面名称:

6号機 廃棄物処理建屋 中2階

[ 単位: mSv/h ]

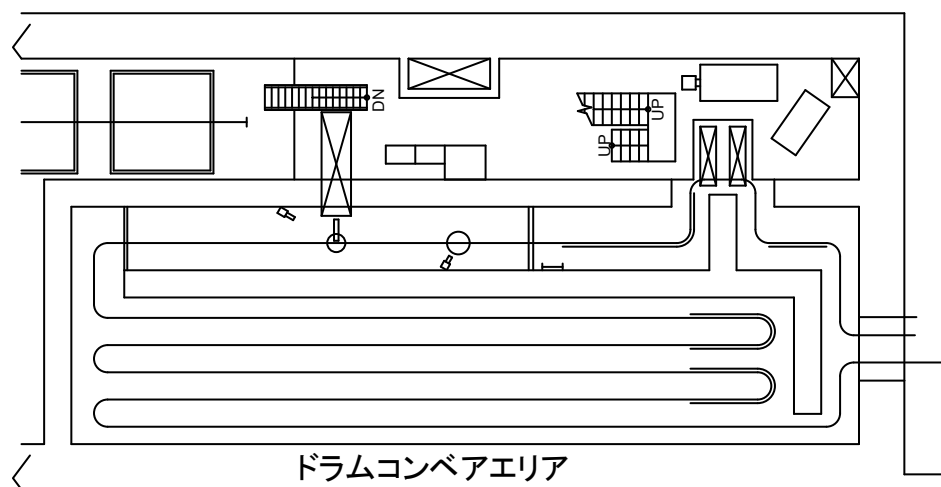



福島第一 原子力発電所	図面名称: 6号機 廃棄物処理建屋 2階	〔 単位: mSv/h 〕
-------------	----------------------	---------------

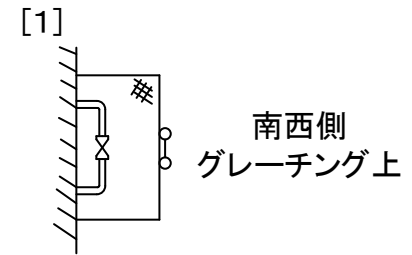
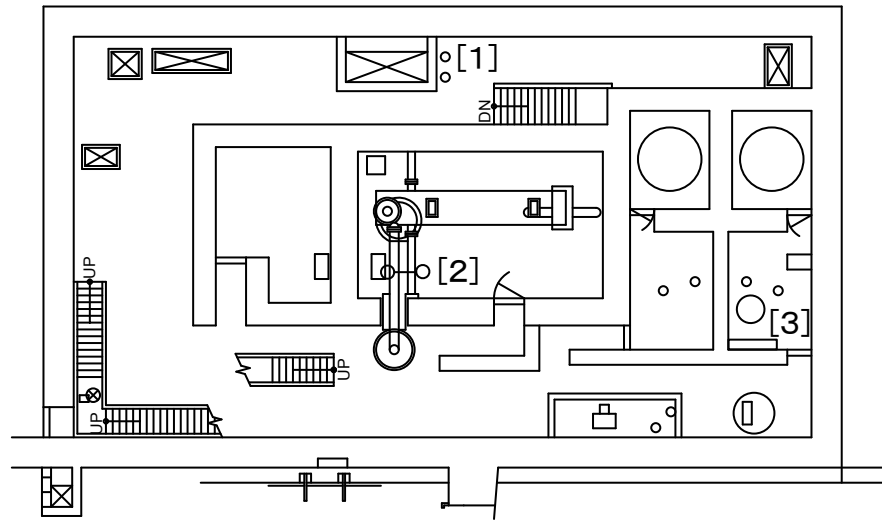

[2] スラッジコンベア

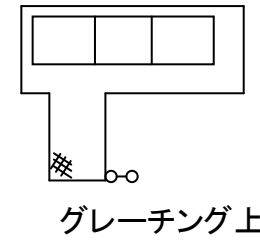

[3]

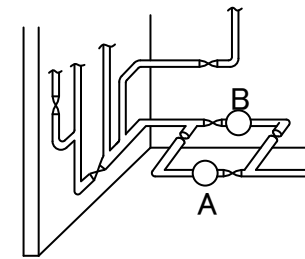

ろ過水ポンプエリア

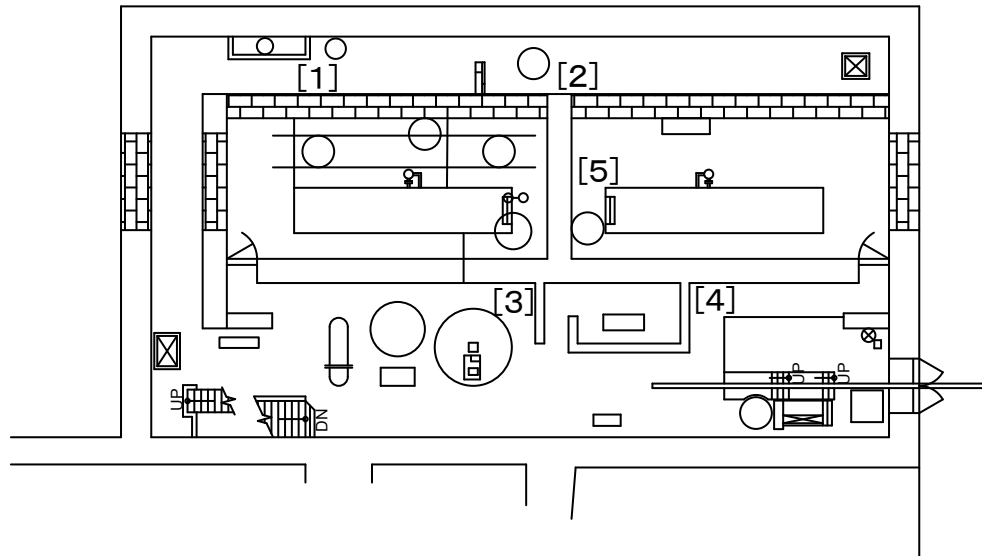

<D/G室>

非常用  
D/G室

HPCS  
D/G室

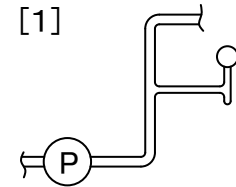

機器ドレン補助ろ過器ポンプ

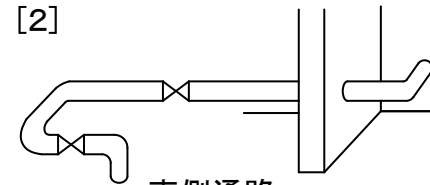

東側通路

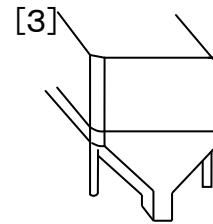

機器ドレンTBF

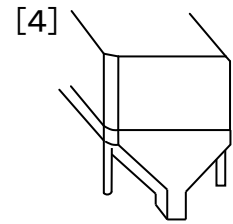

床ドレンTBF

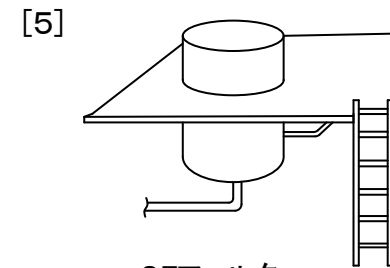

SFフィルター