

2018年2月1日  
東京電力ホールディングス株式会社  
福島第一廃炉推進カンパニー

# 建屋内の空間線量率について

データ採取期間

- ・ 5号機 : 2017年11月1日～2017年11月30日

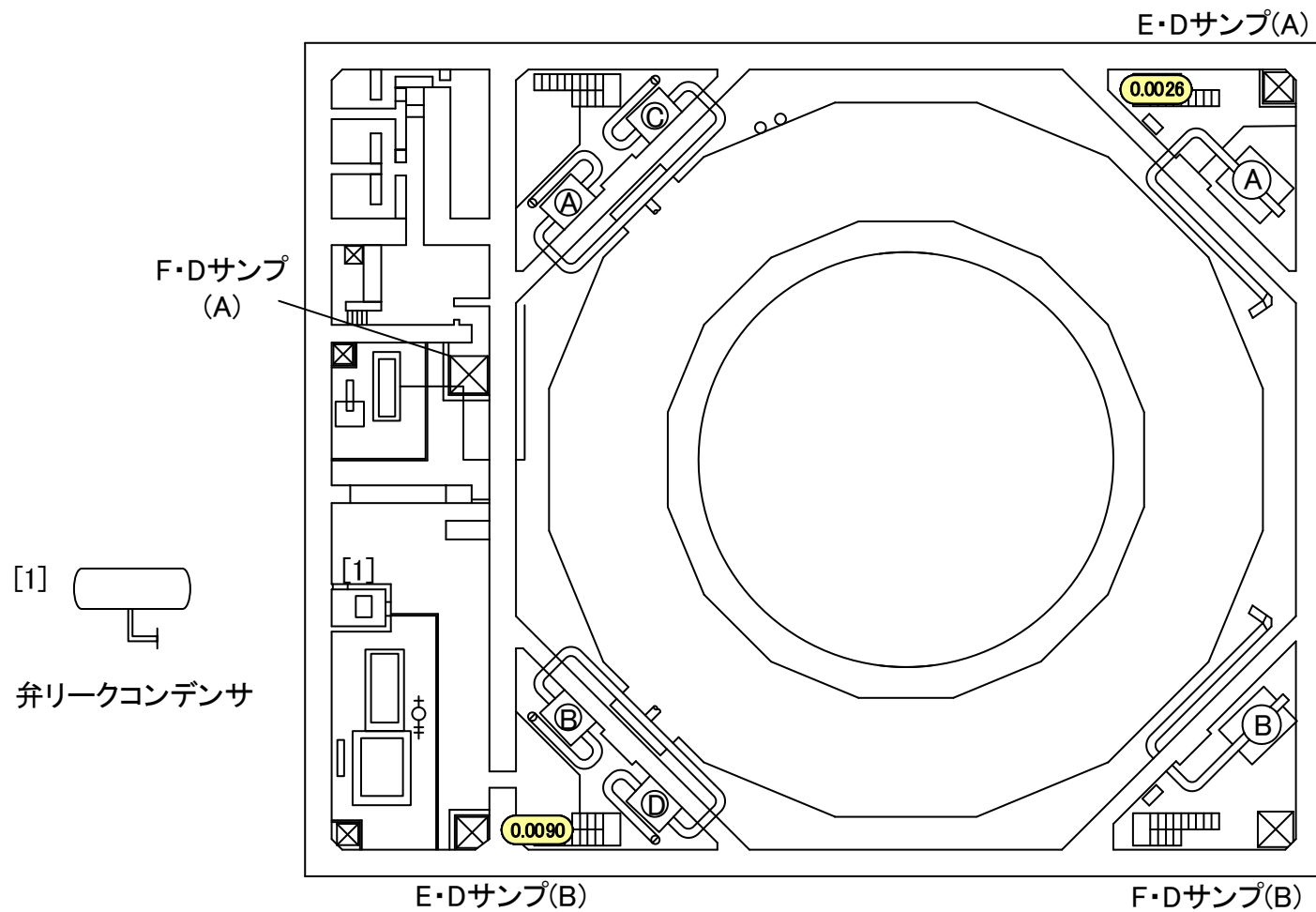

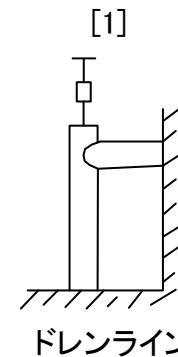
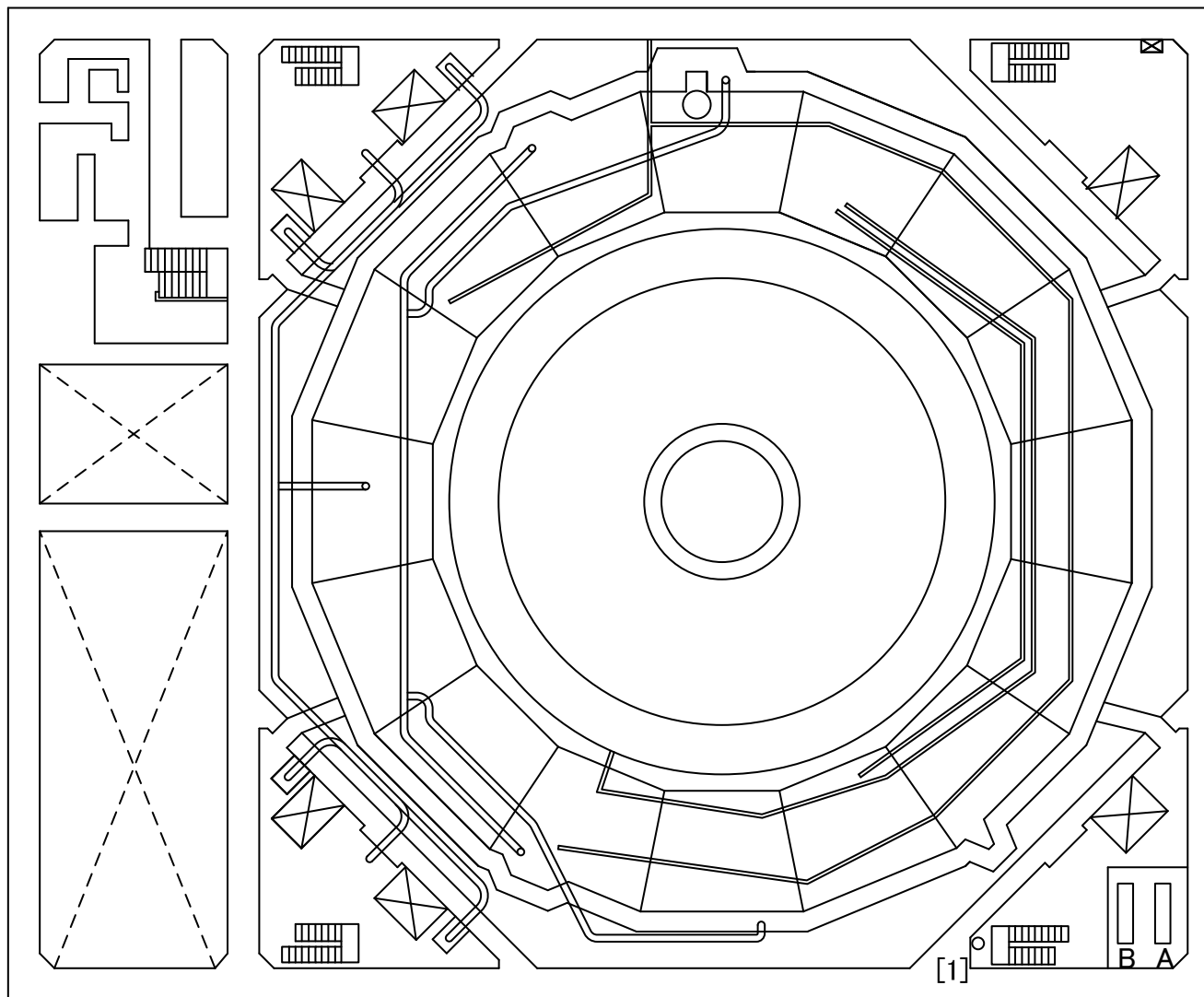

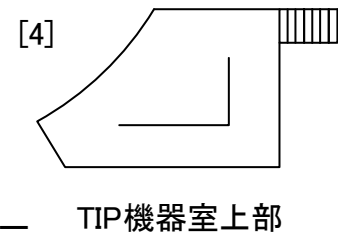
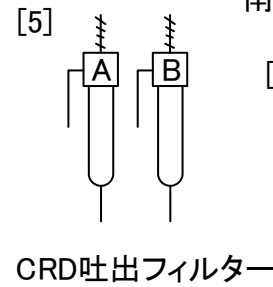
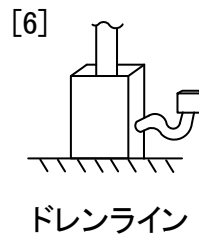
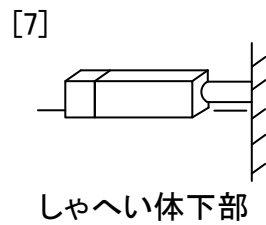
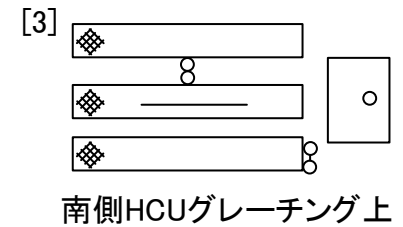
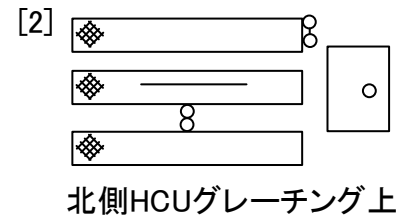
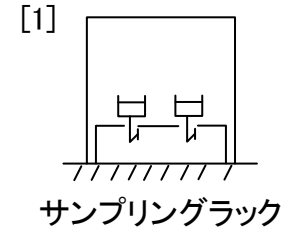
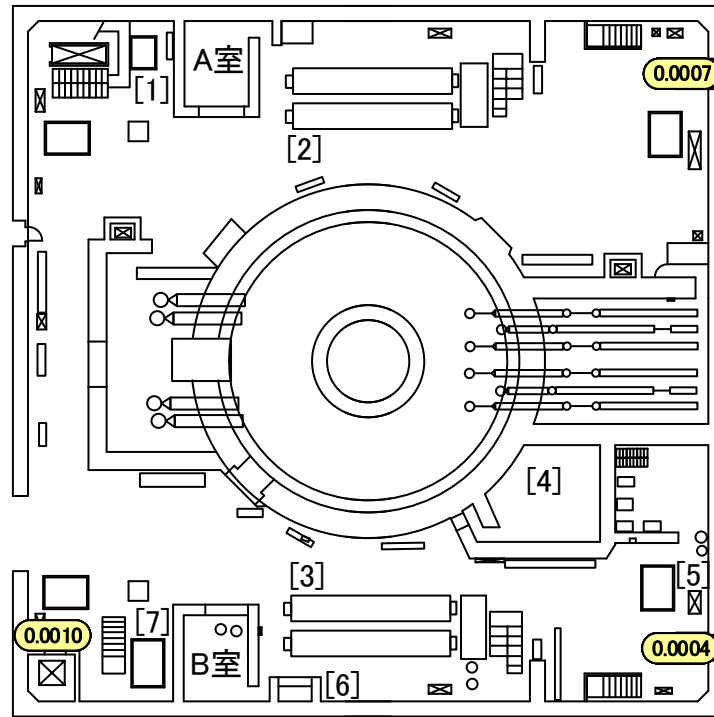

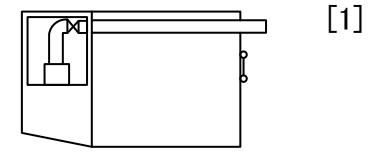
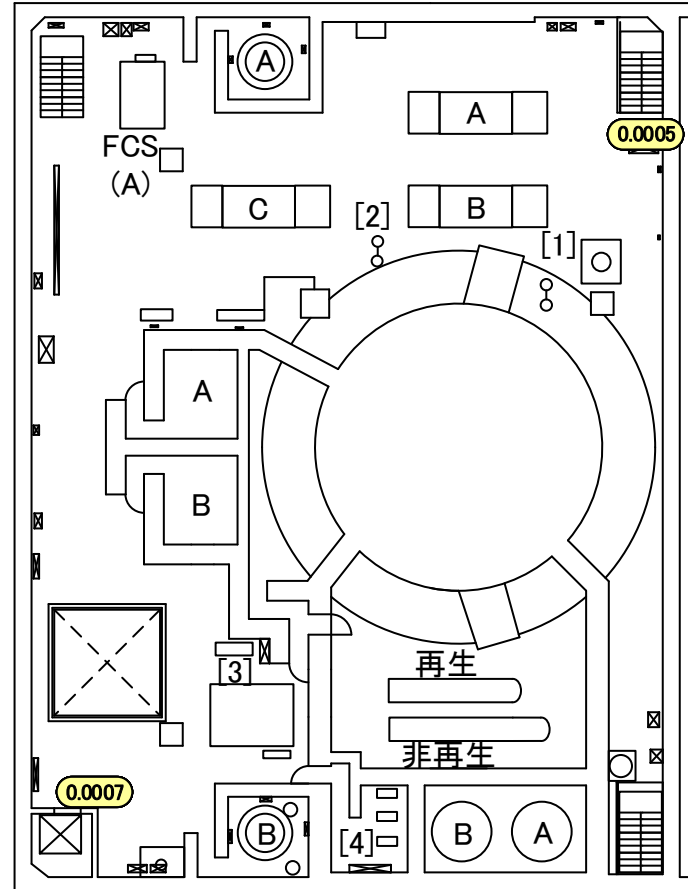

北東側グレーチング上

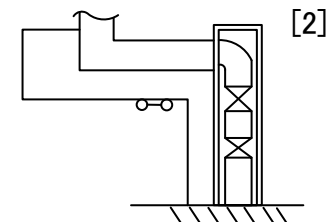

北側グレーチング上

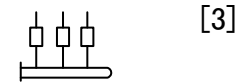

計装ラック下部

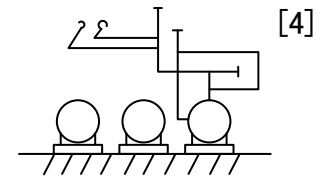

スラッジ放出混合ポンプ

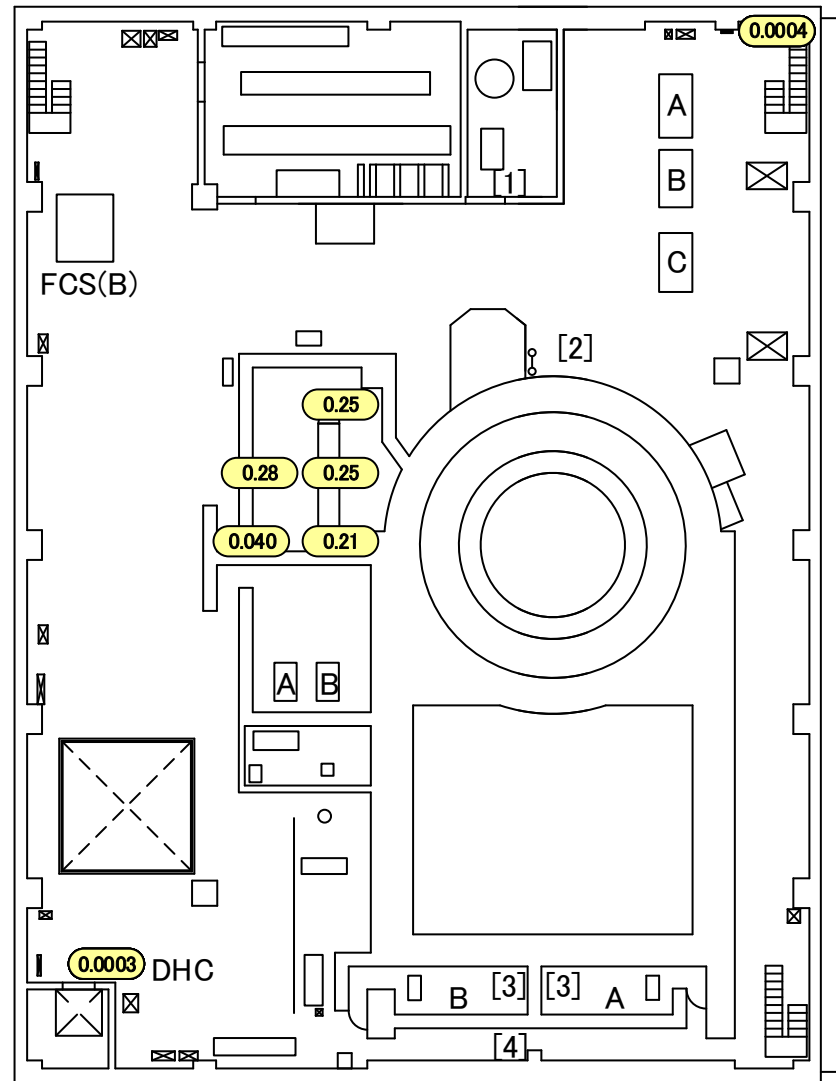
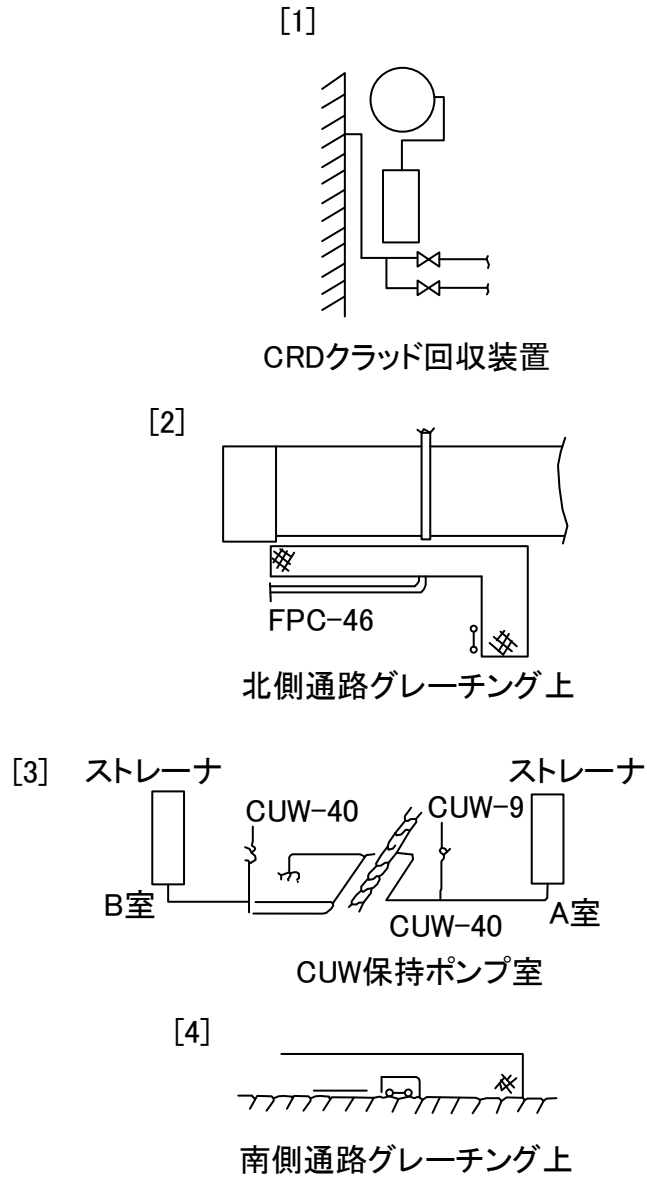

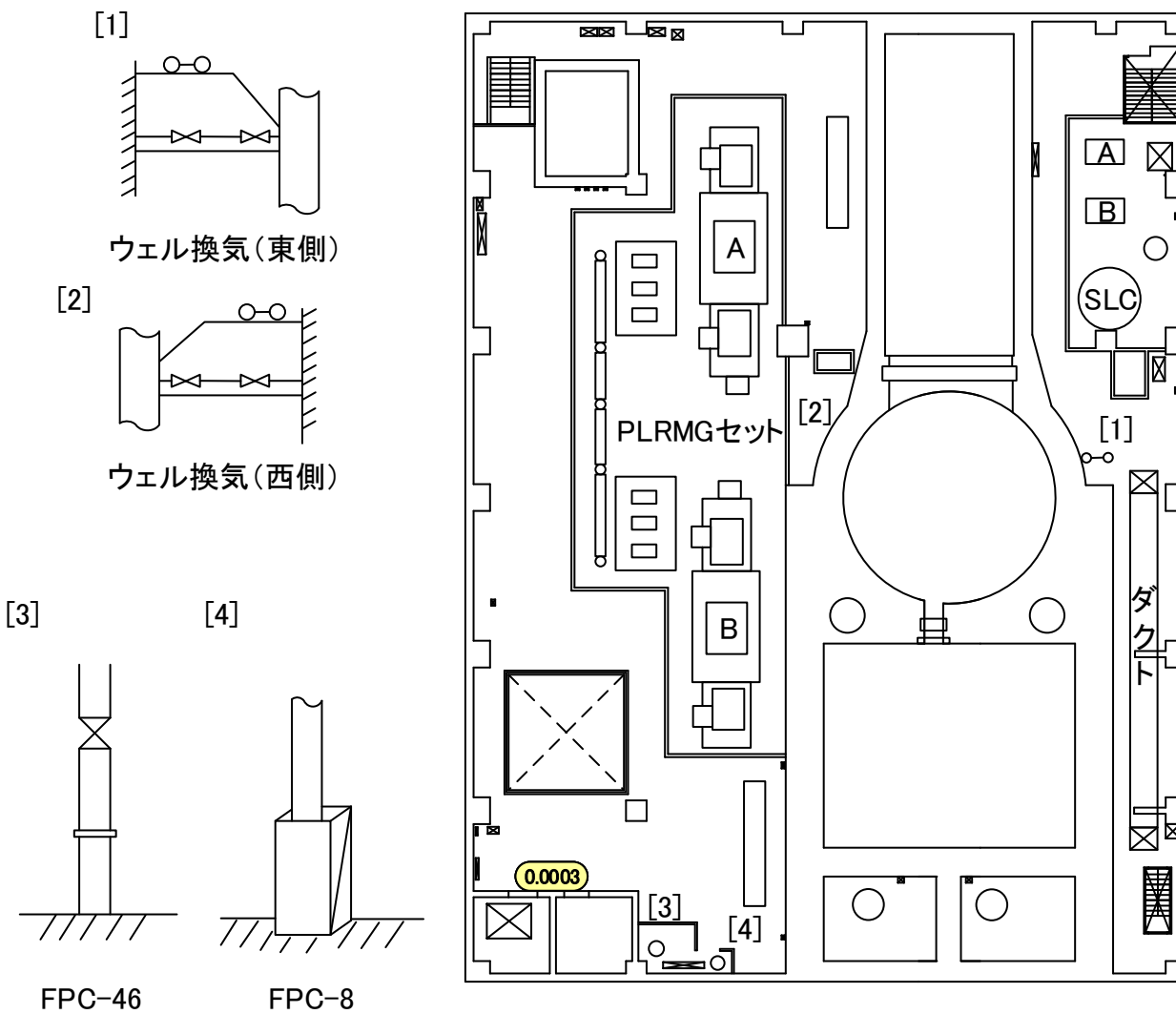

福島第一 原子力発電所

図面名称:

5号機 原子炉建屋 5階

[ 単位: mSv/h ]

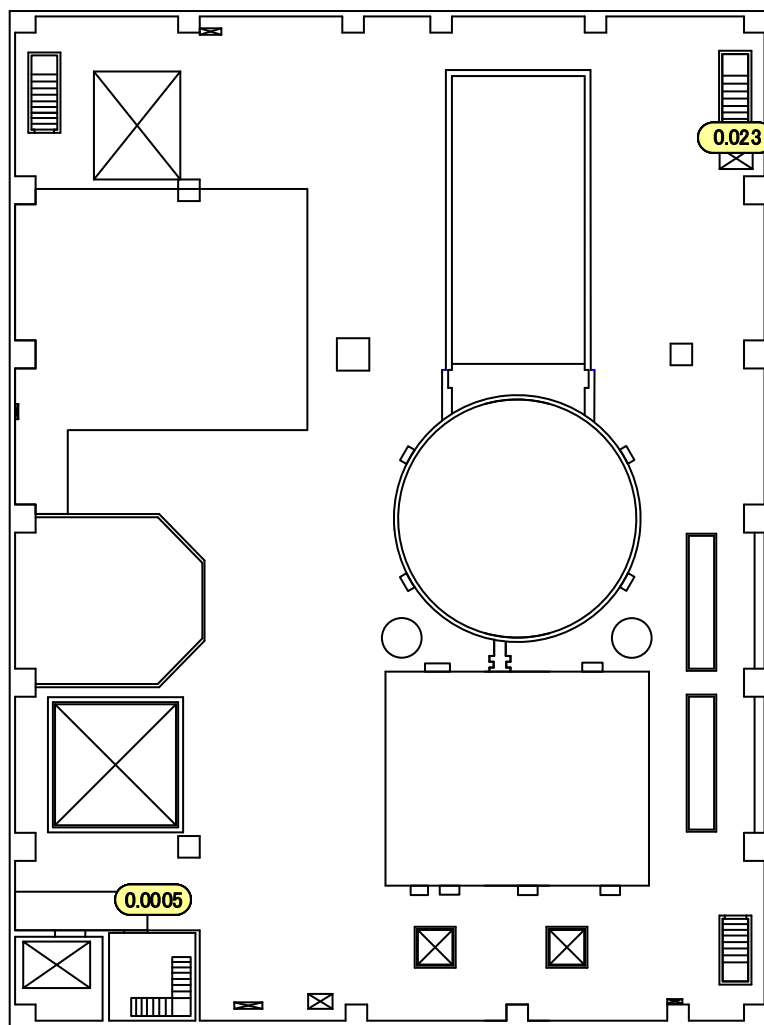



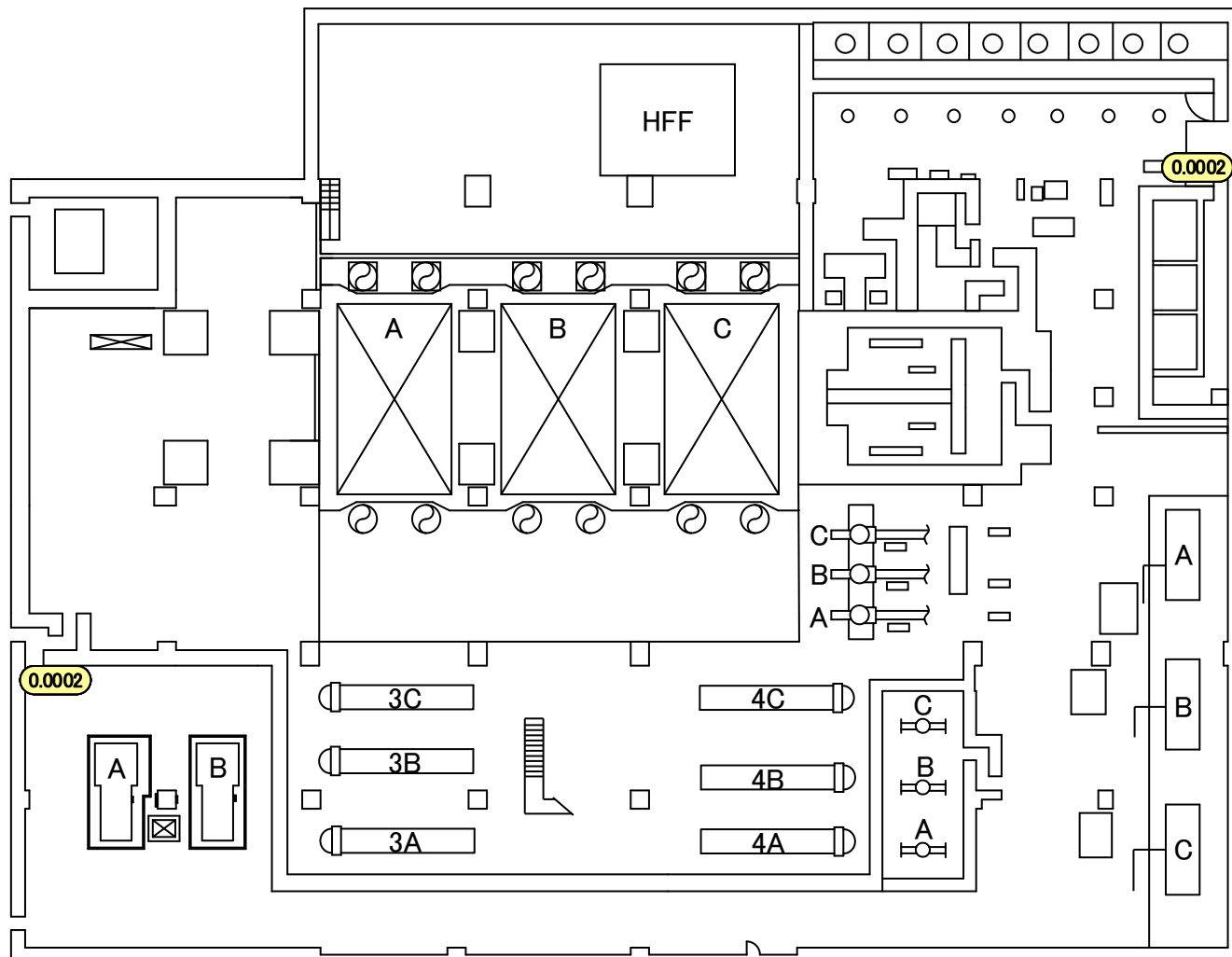

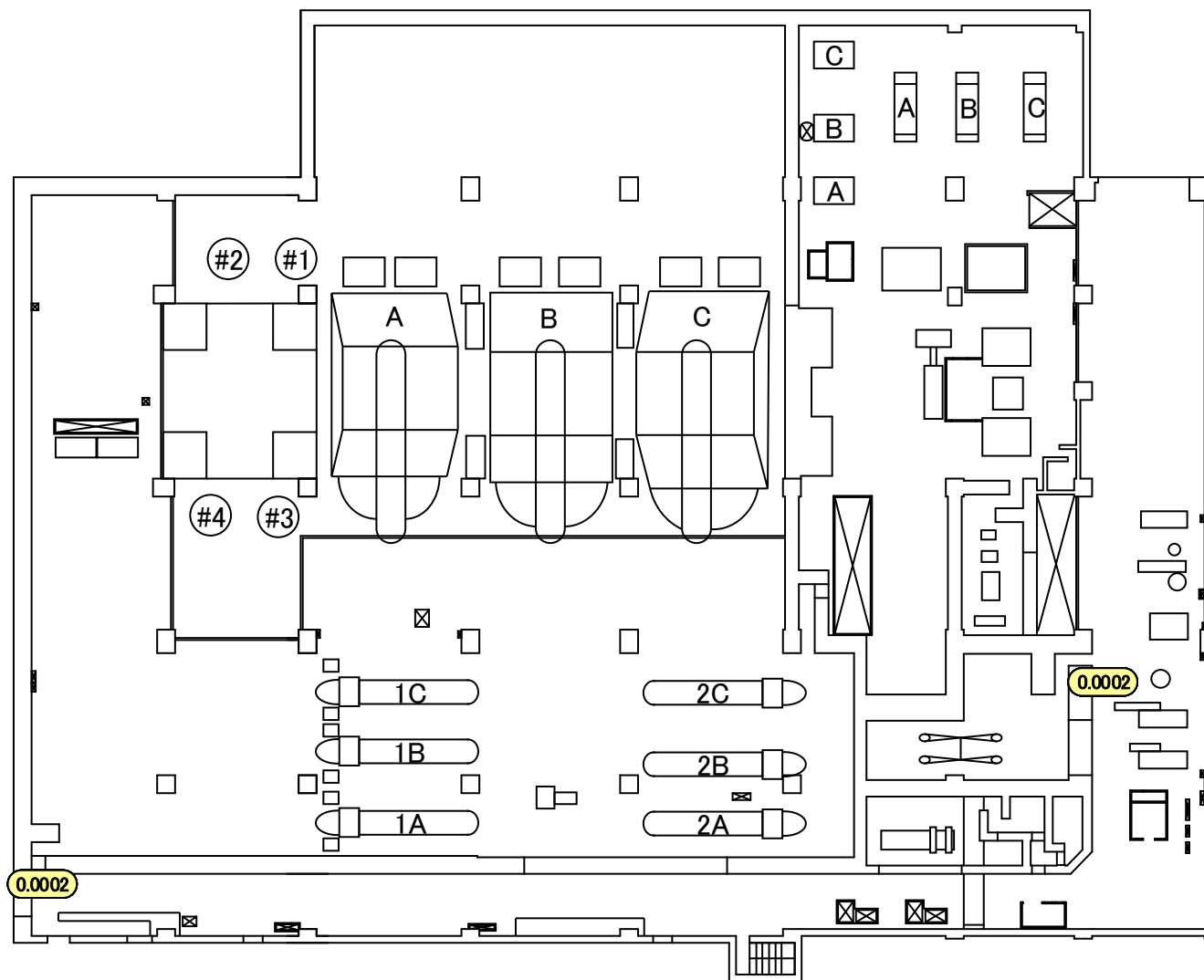

[1]  
AS-23

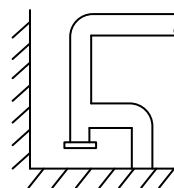

[2]  
エバポレータ

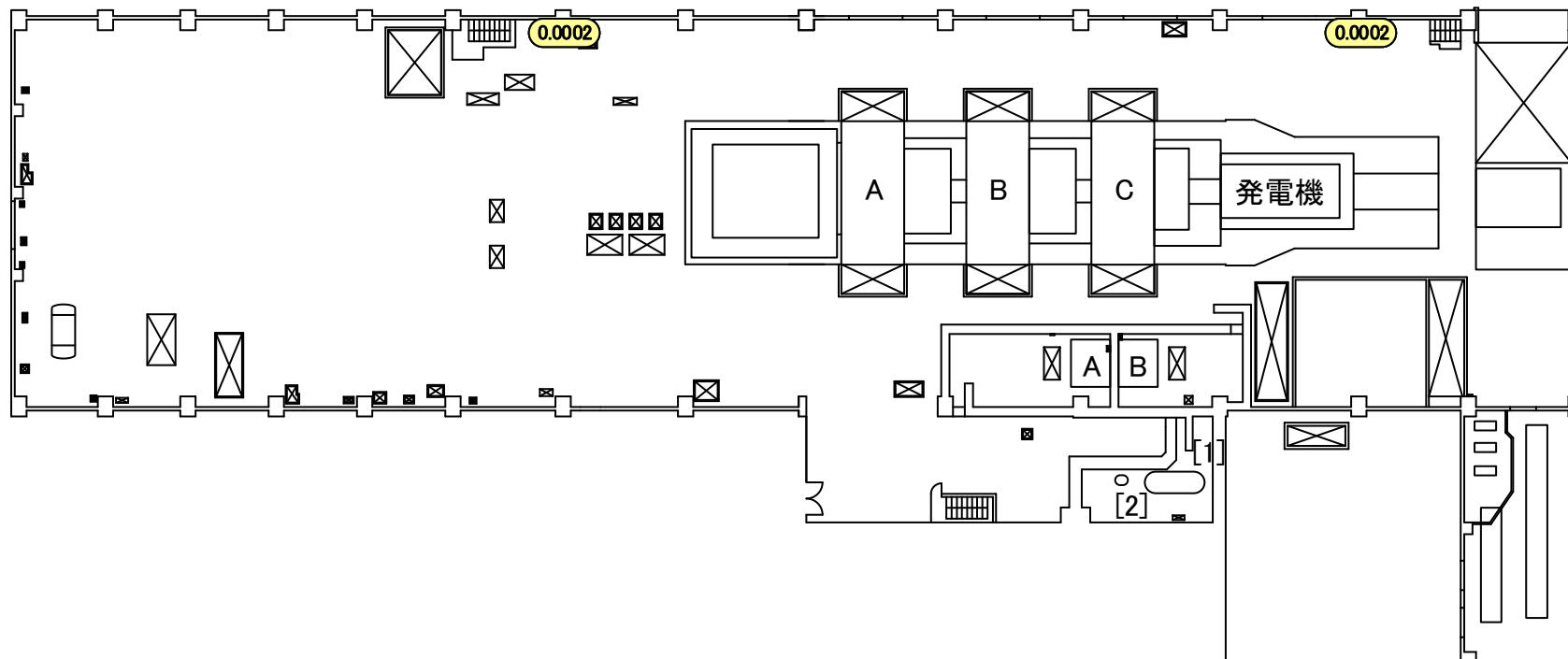
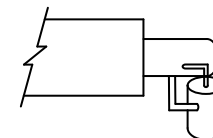

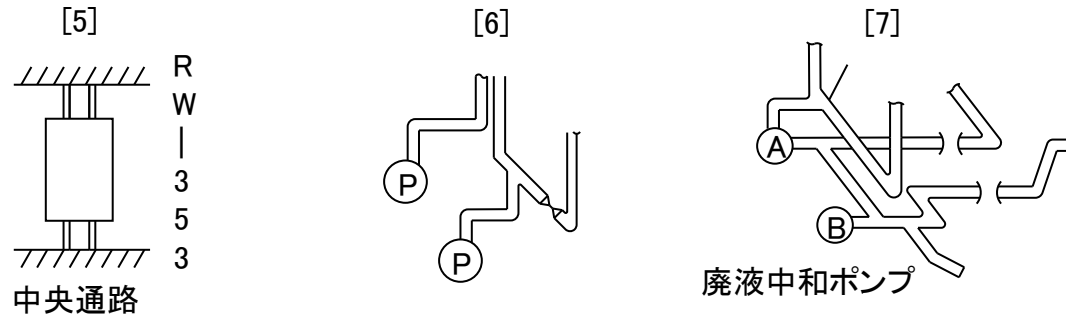
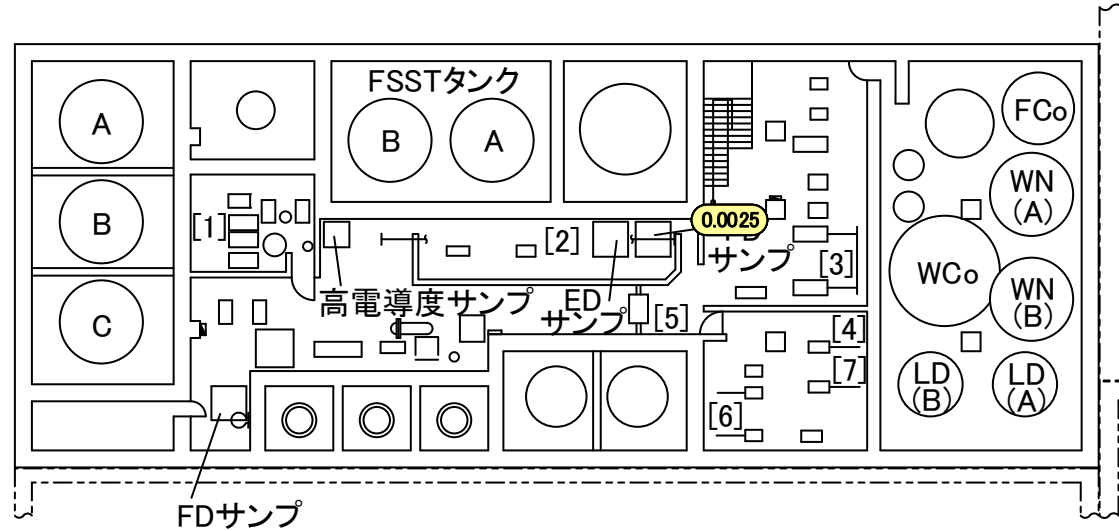
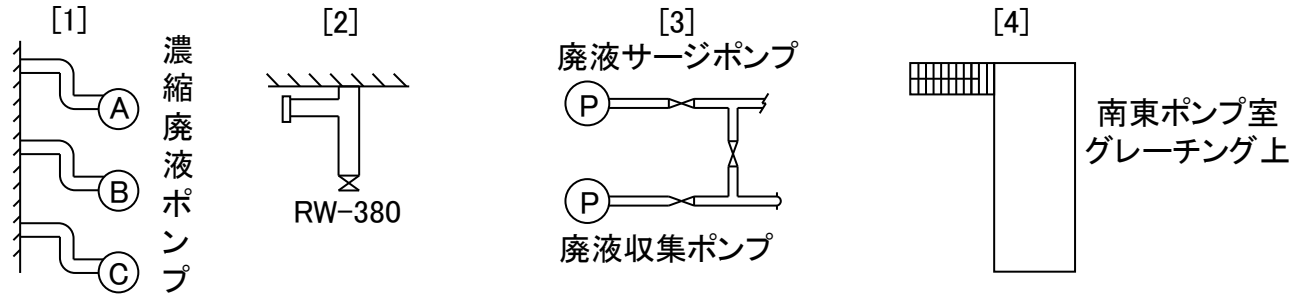

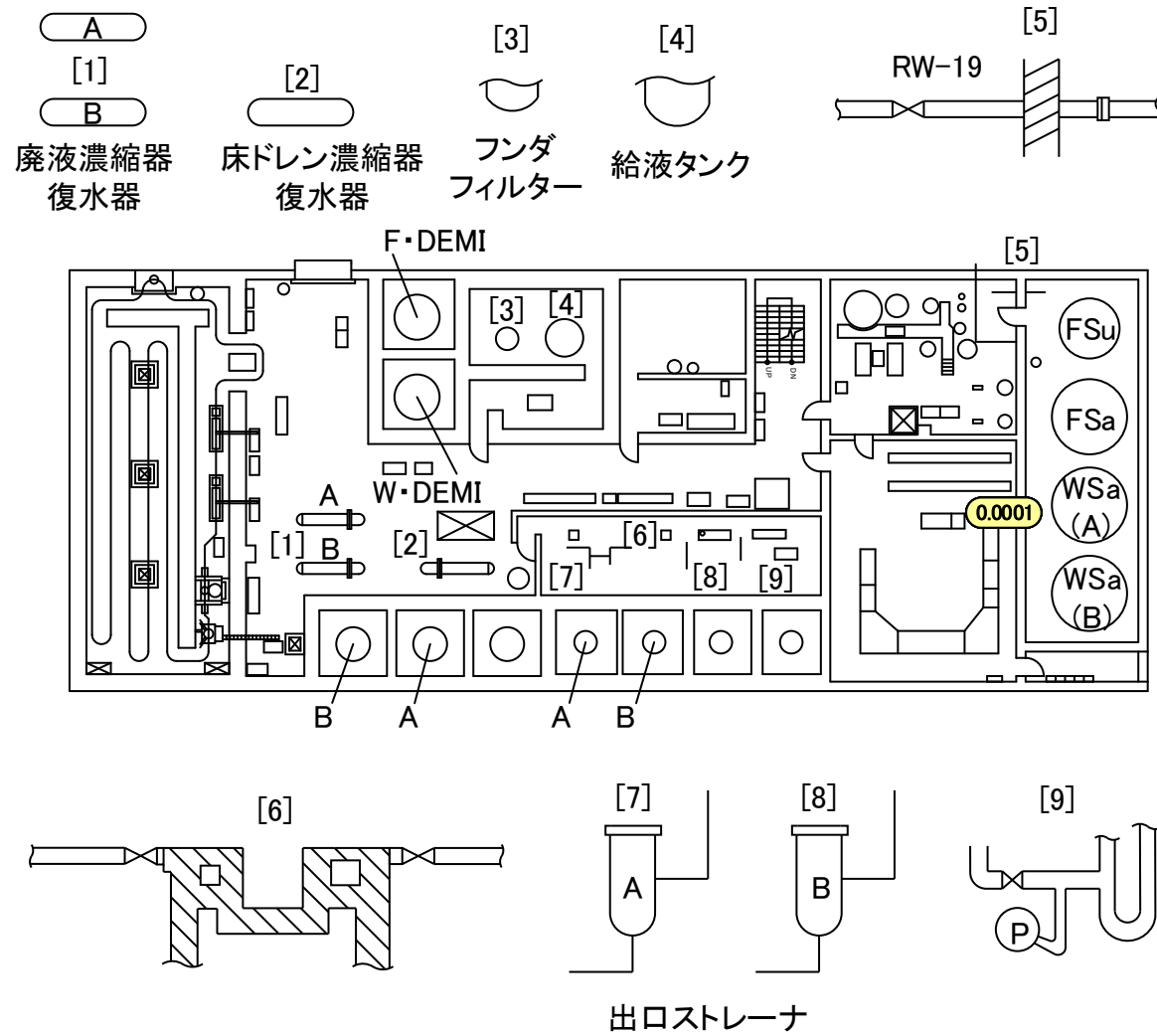

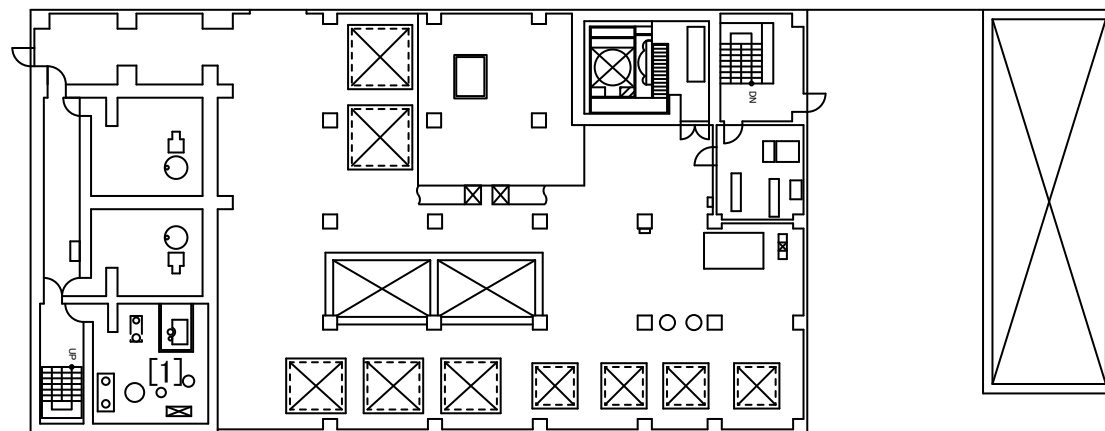

[1]



濃縮廃液計量タンク

福島第一 原子力発電所

図面名称:

5号機 廃棄物処理建屋 3階

[ 単位: mSv/h ]

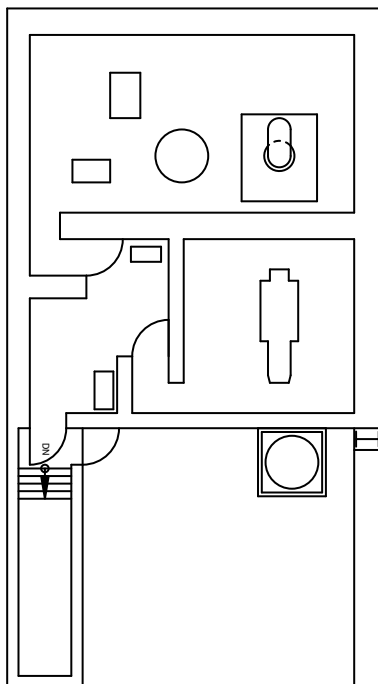

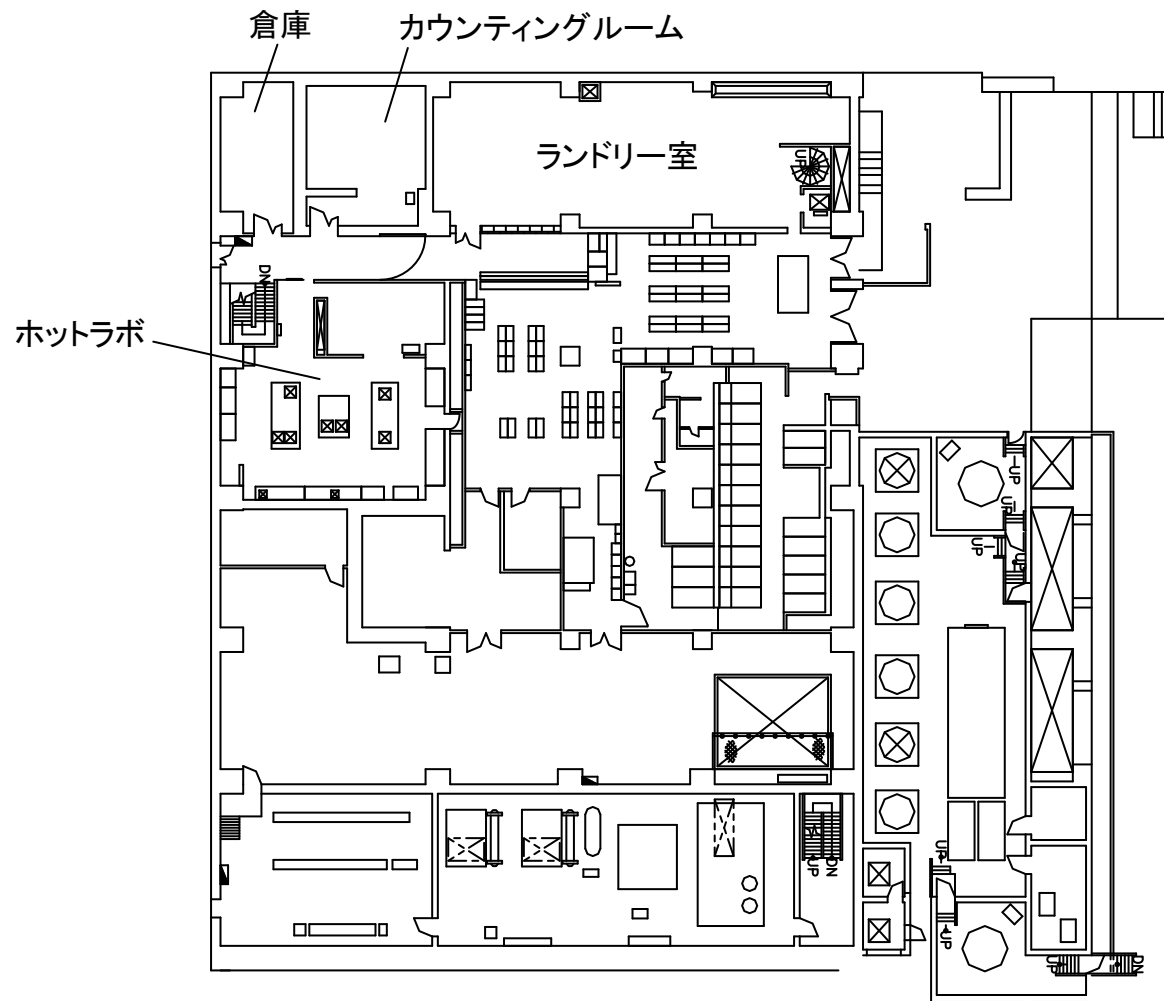



福島第一 原子力発電所

図面名称:

5・6号機 サービス建屋 2階

[ 単位: mSv/h ]

