

2017年9月29日
東京電力ホールディングス株式会社

建屋内の空間線量率について

データ採取期間

- ・ 6号機 : 2017年7月1日～2017年7月31日

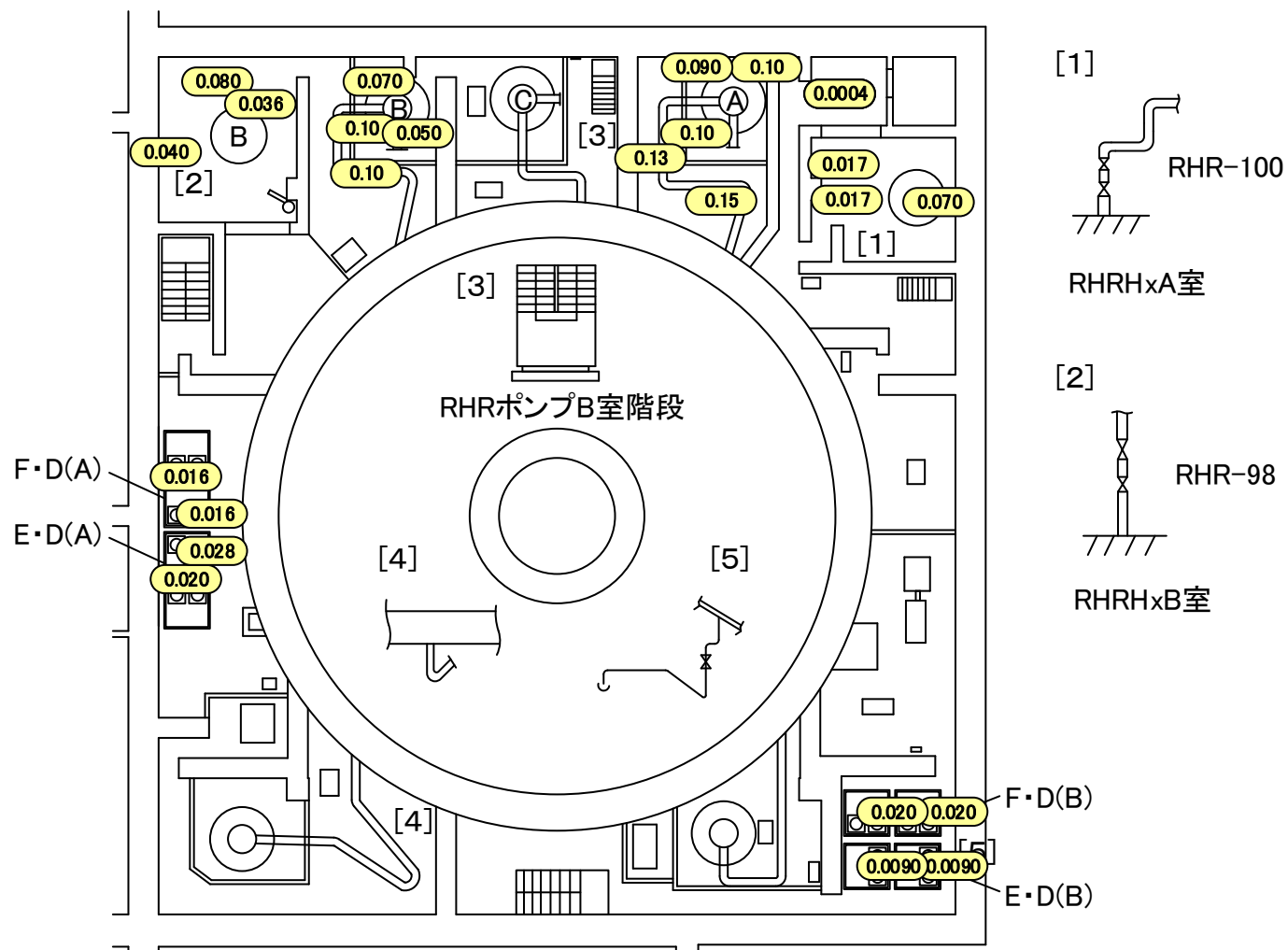

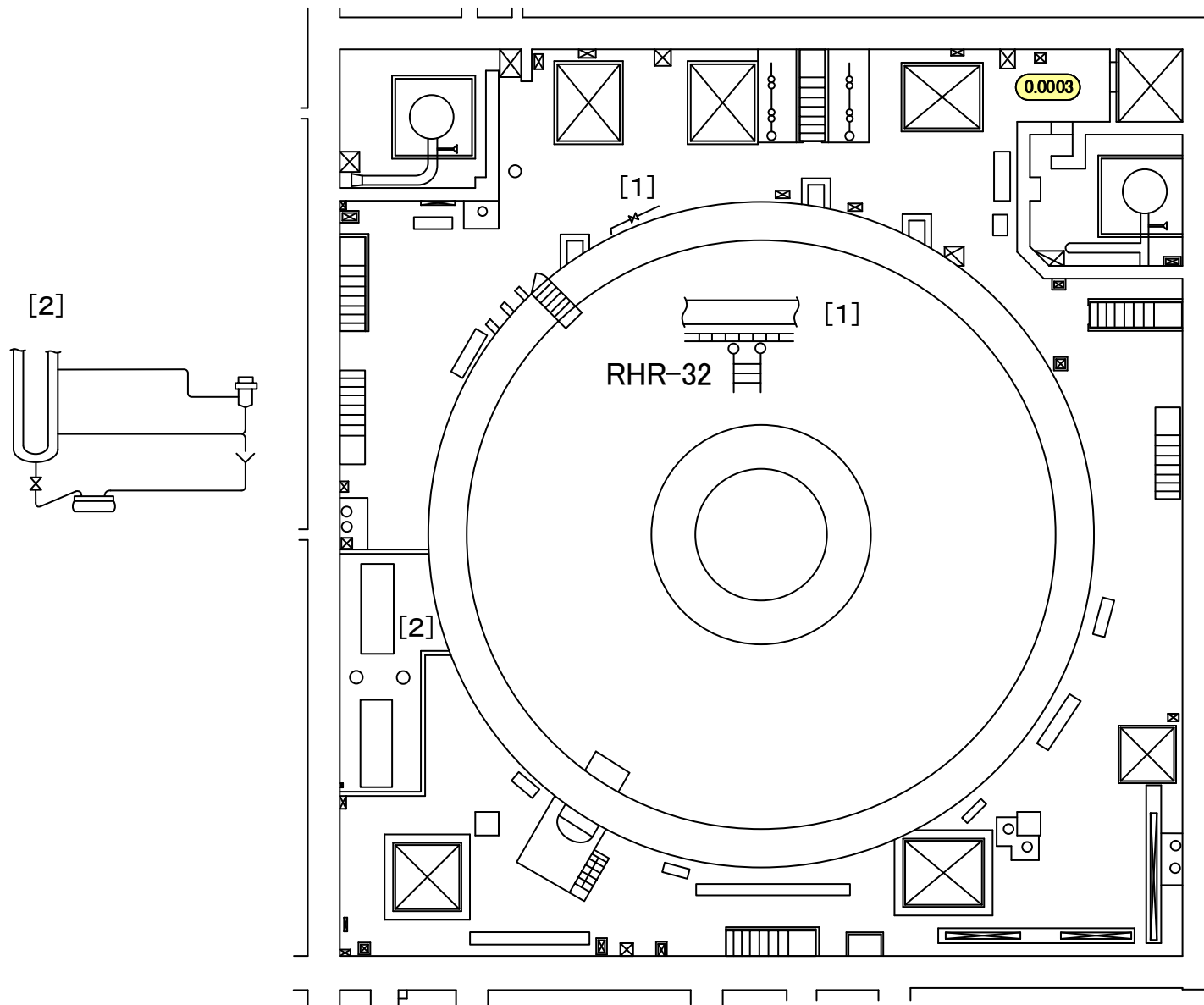

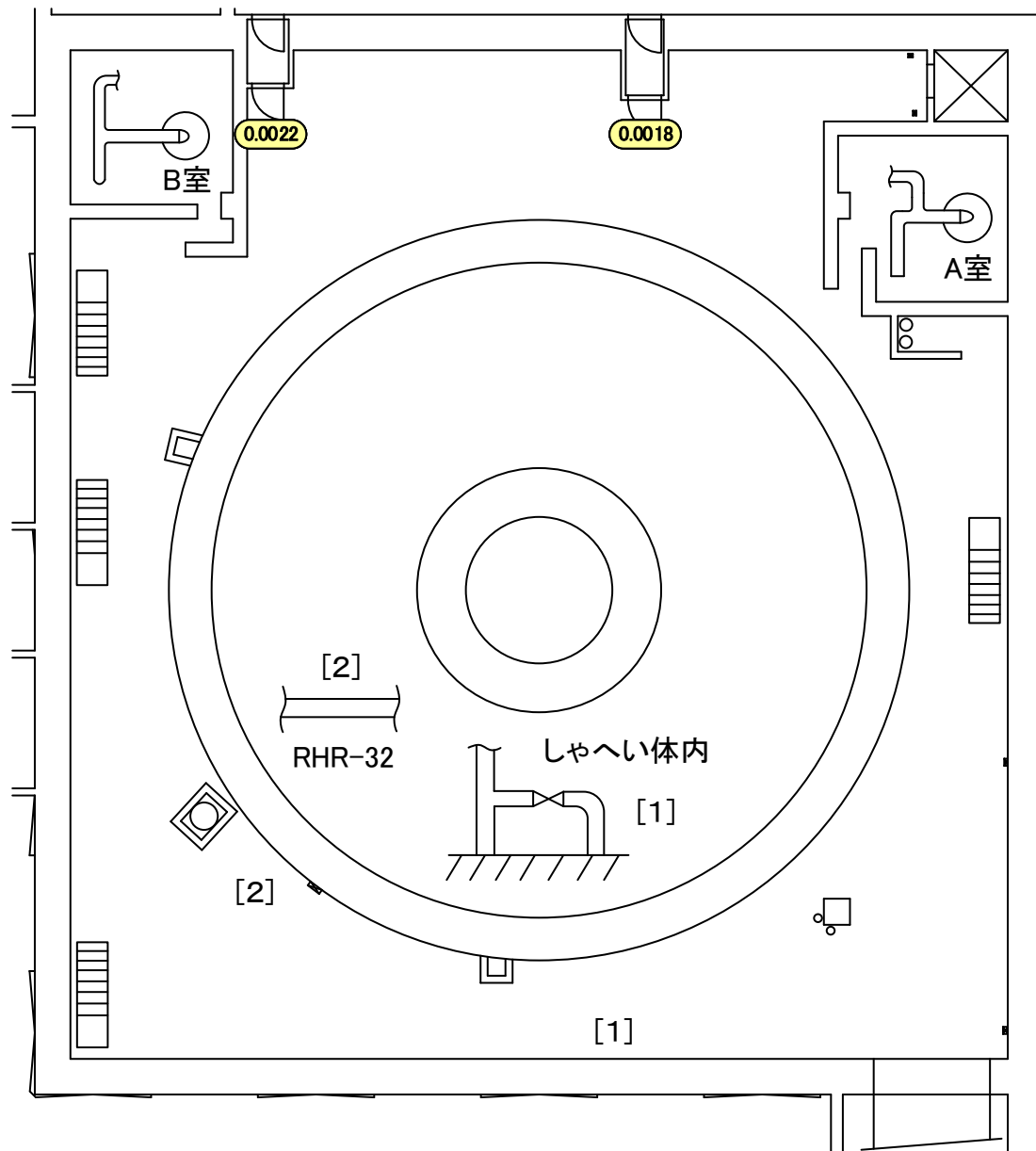

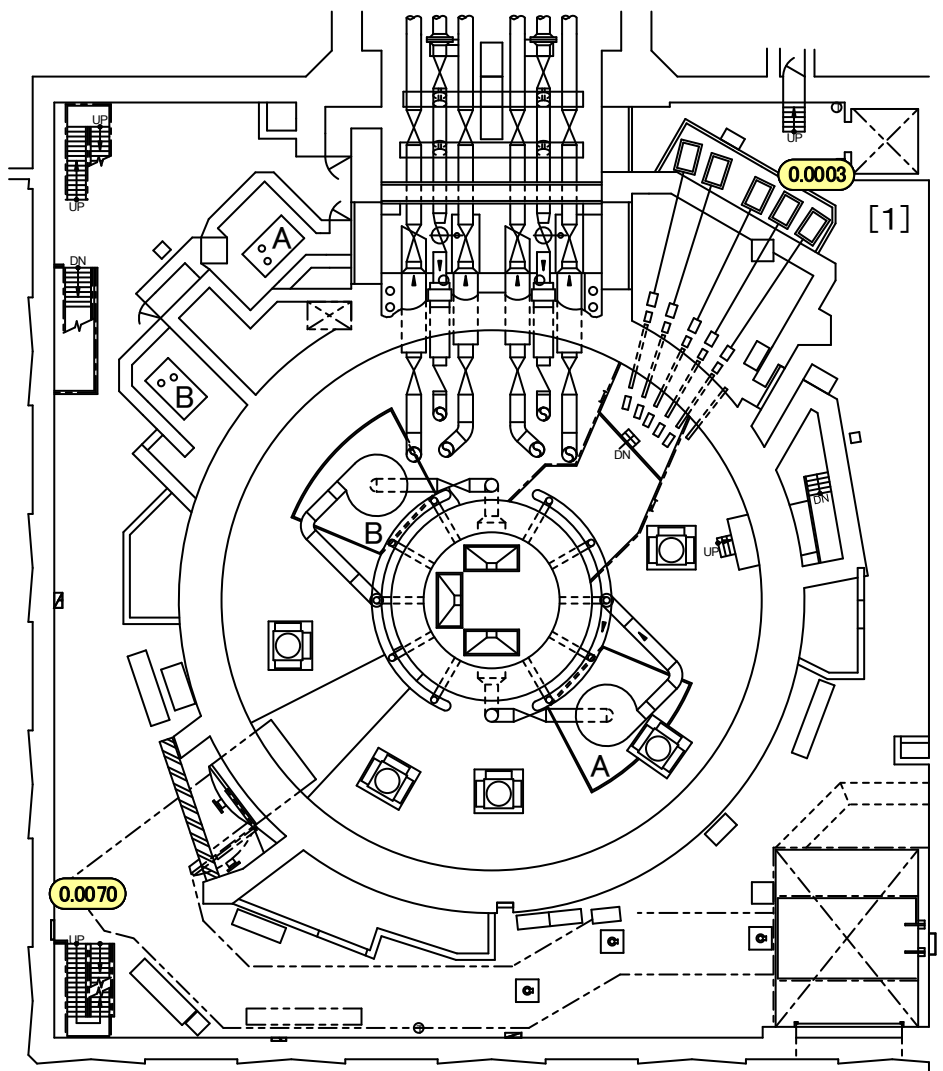

[1]
サンプリング
ラック

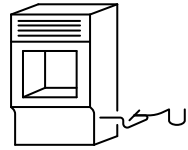

[2]
グレーチング
上

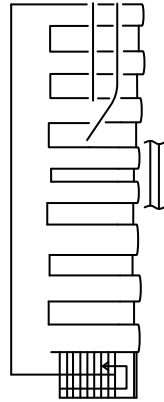

[3]
CRD吐出
フィルター

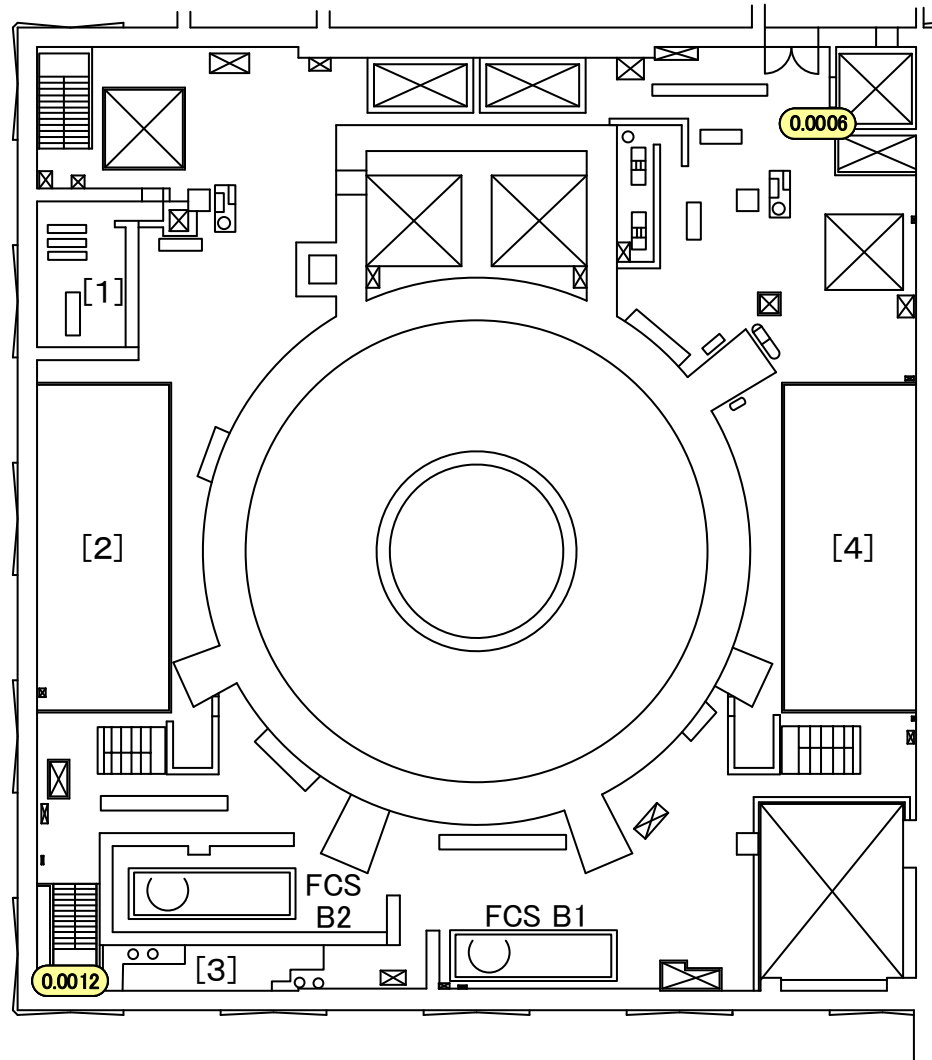
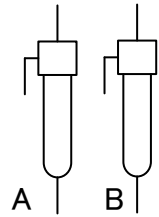

[4]
グレーチング
上

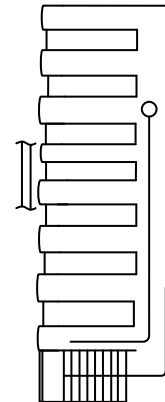

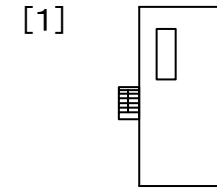
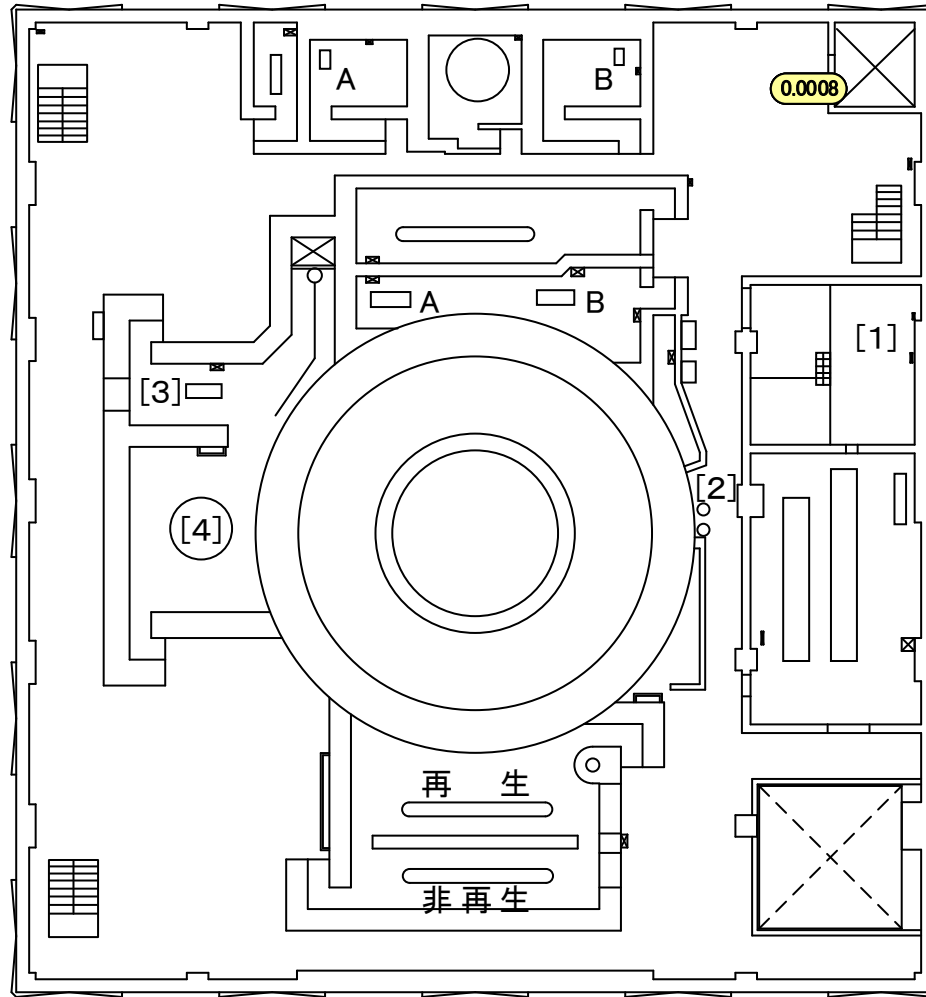

[1]
CRD半自動分解装置
操作エリア

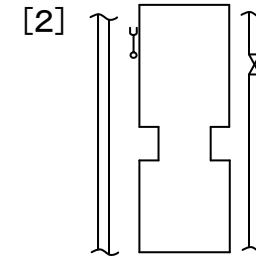

[2]
南側通路
グレーチング上



[3]
CUW逆洗水移送ポンプ

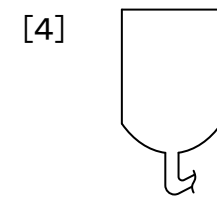

[4]
CUW逆洗水受タンク

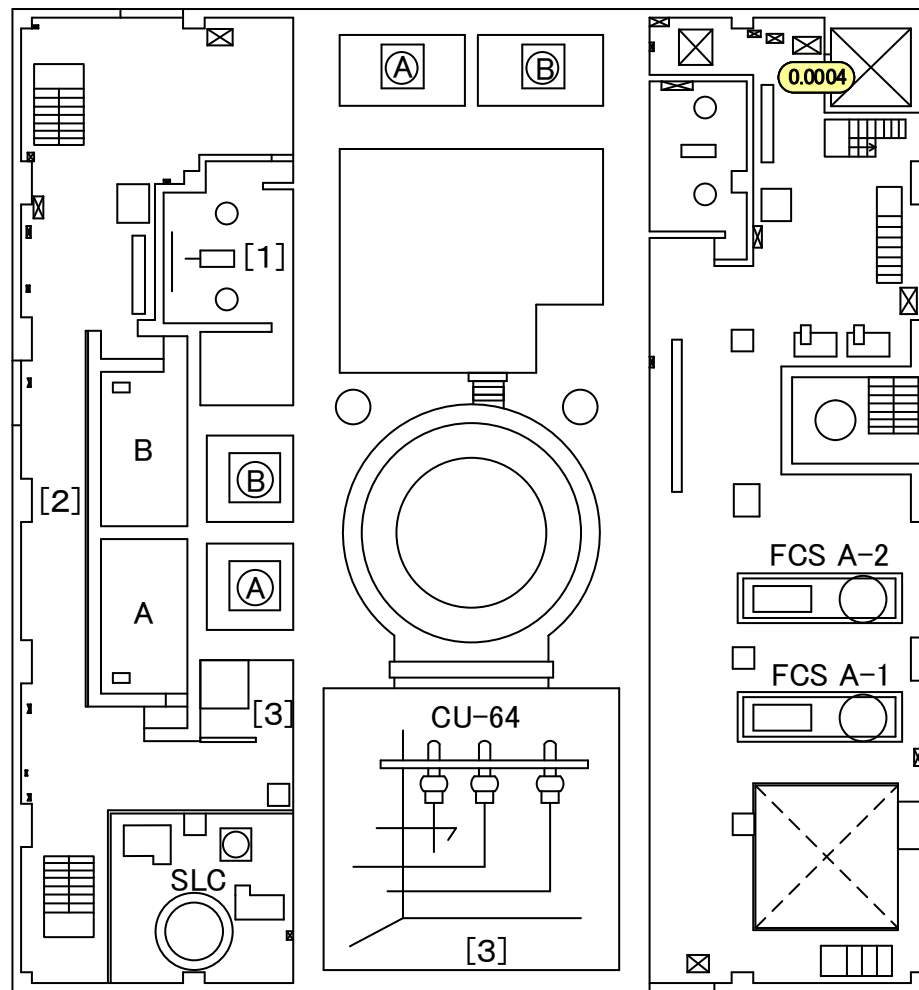
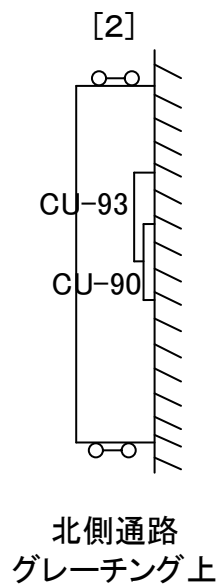
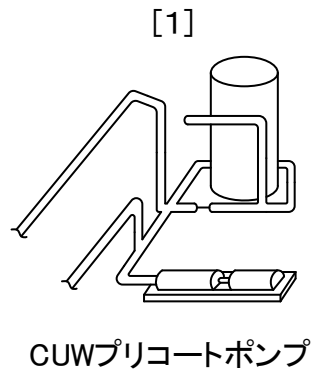

福島第一 原子力発電所

図面名称:

6号機 原子炉建屋 6階

[単位: mSv/h]

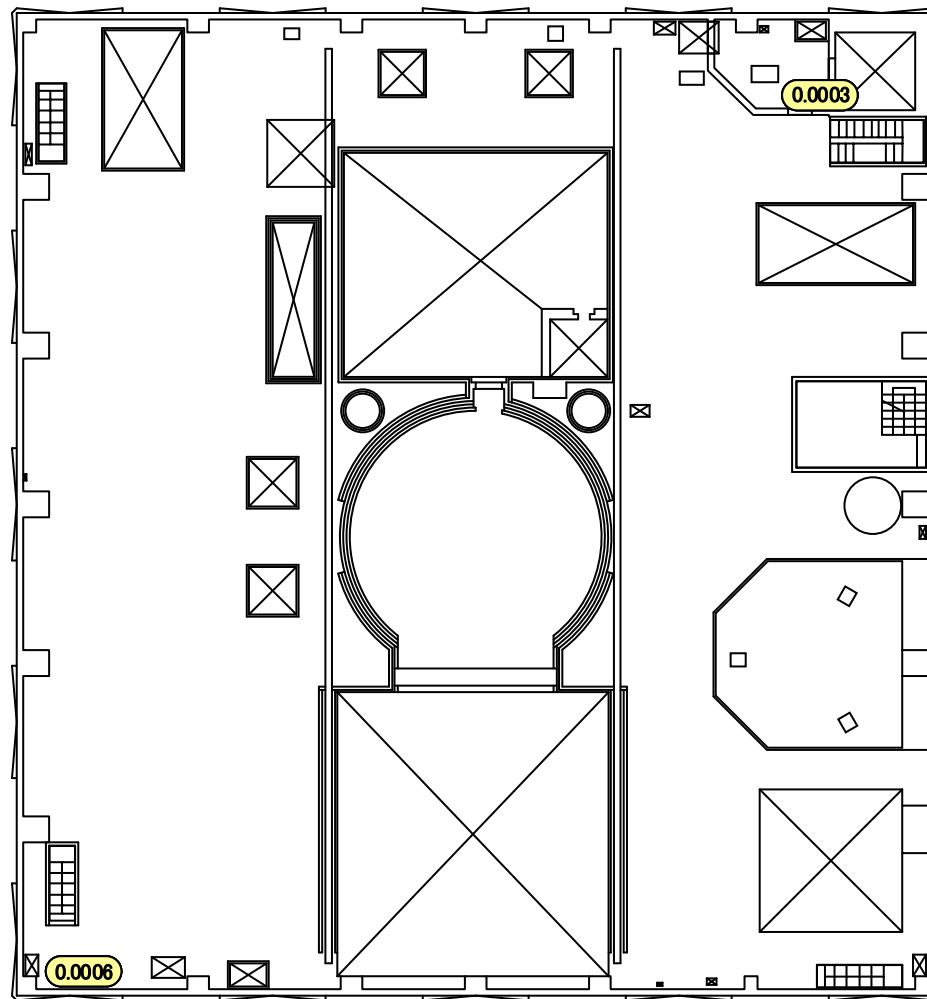

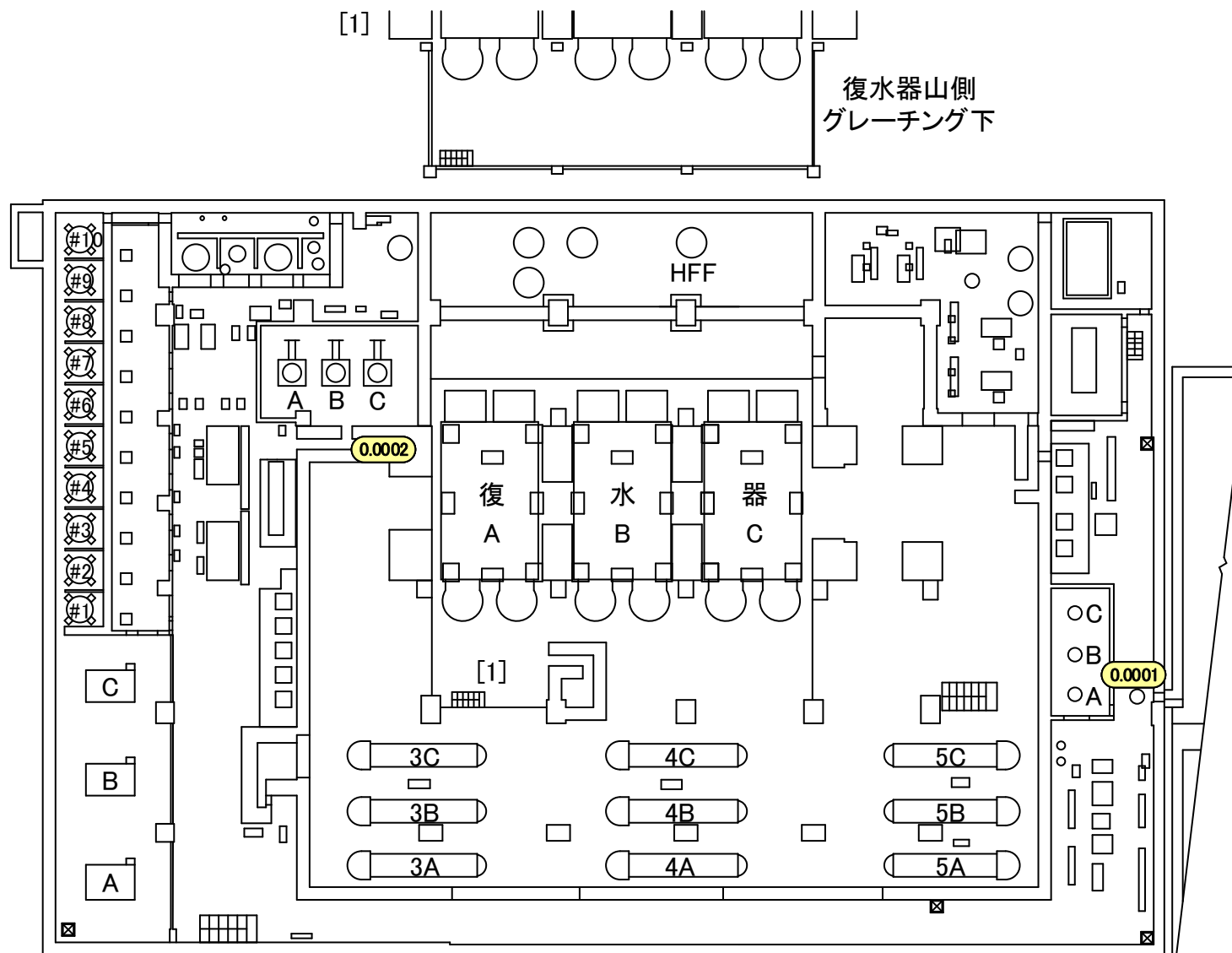

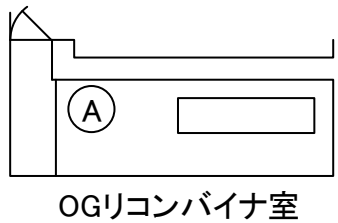
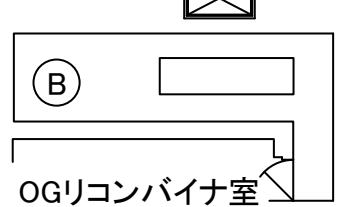
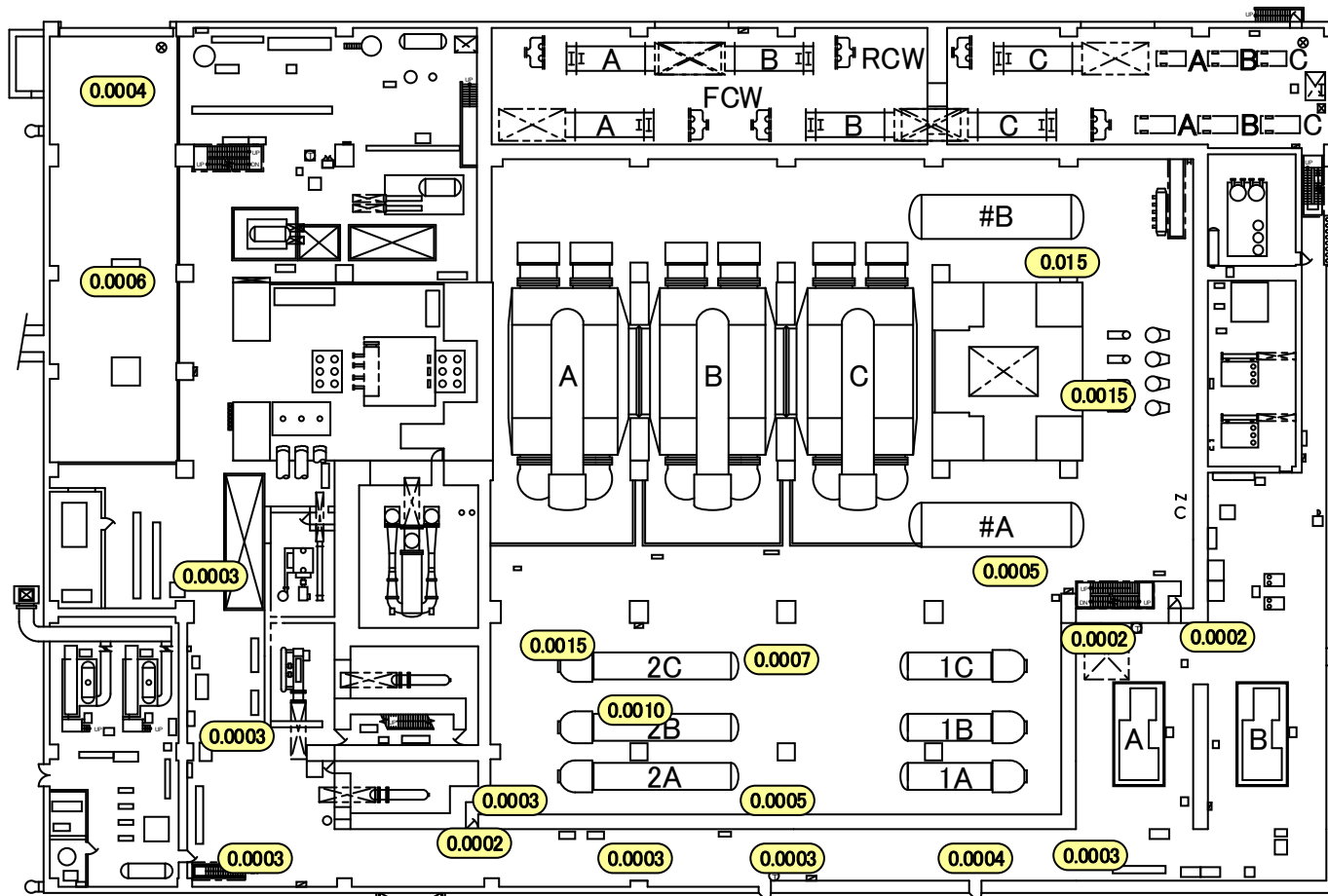

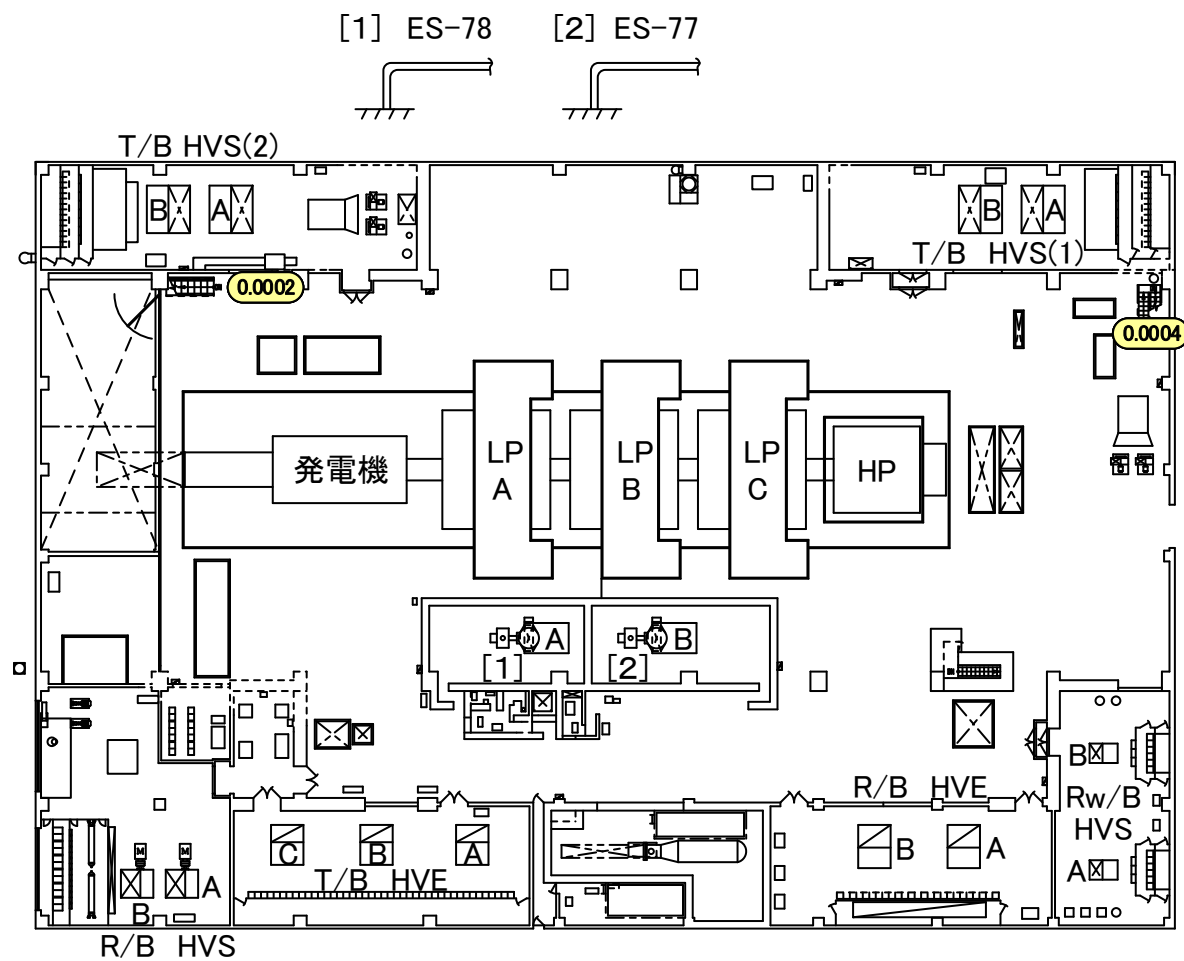

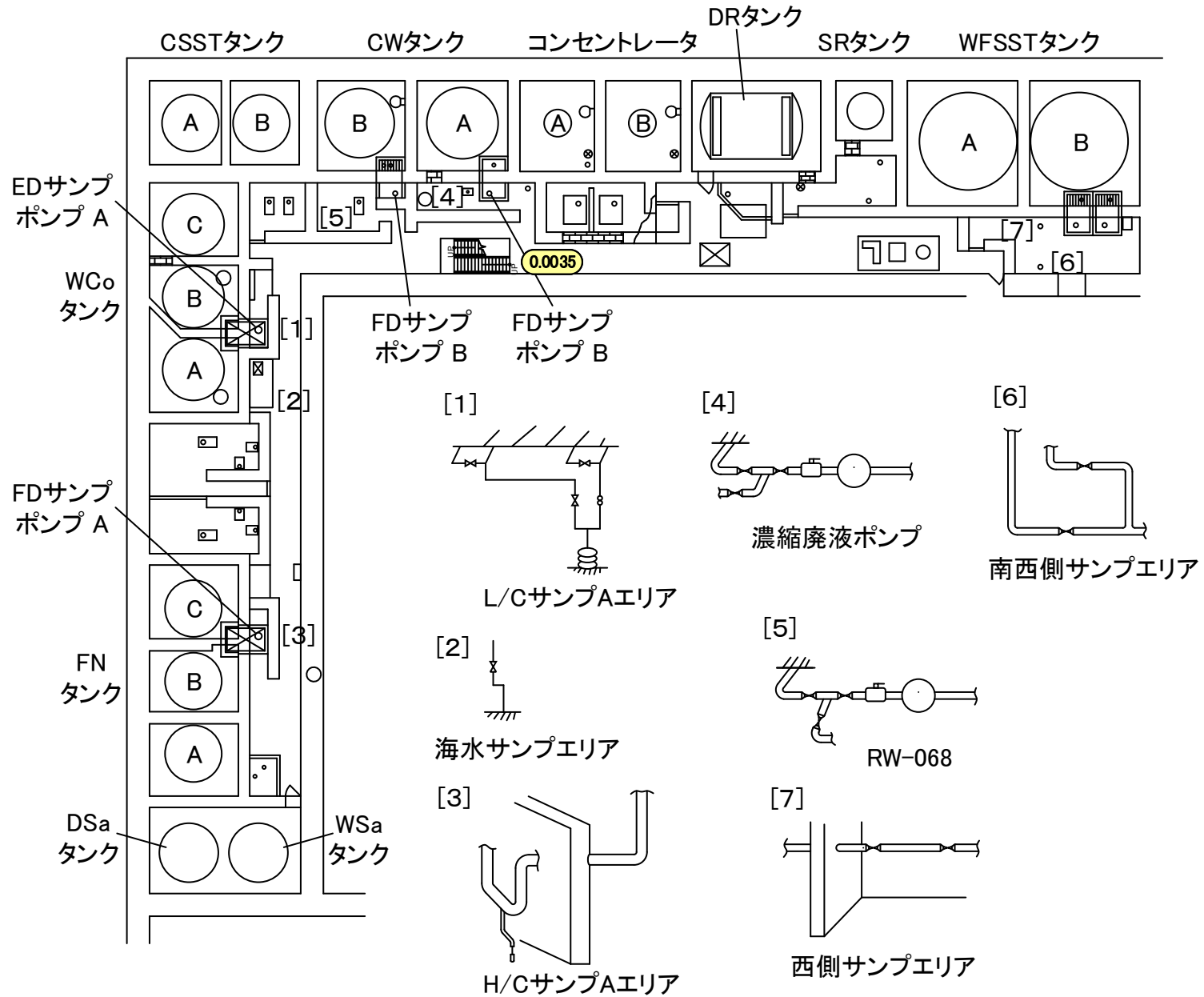

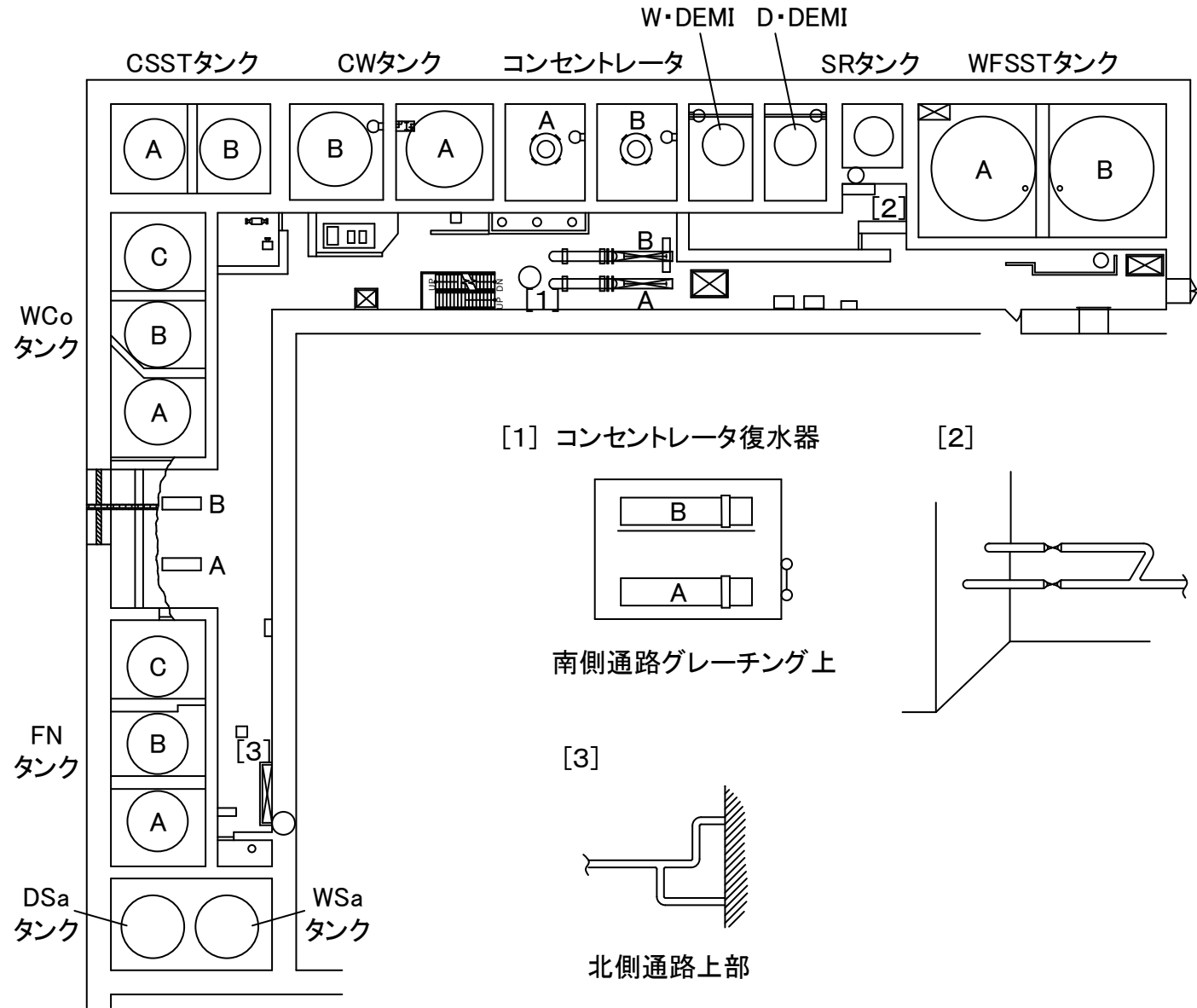

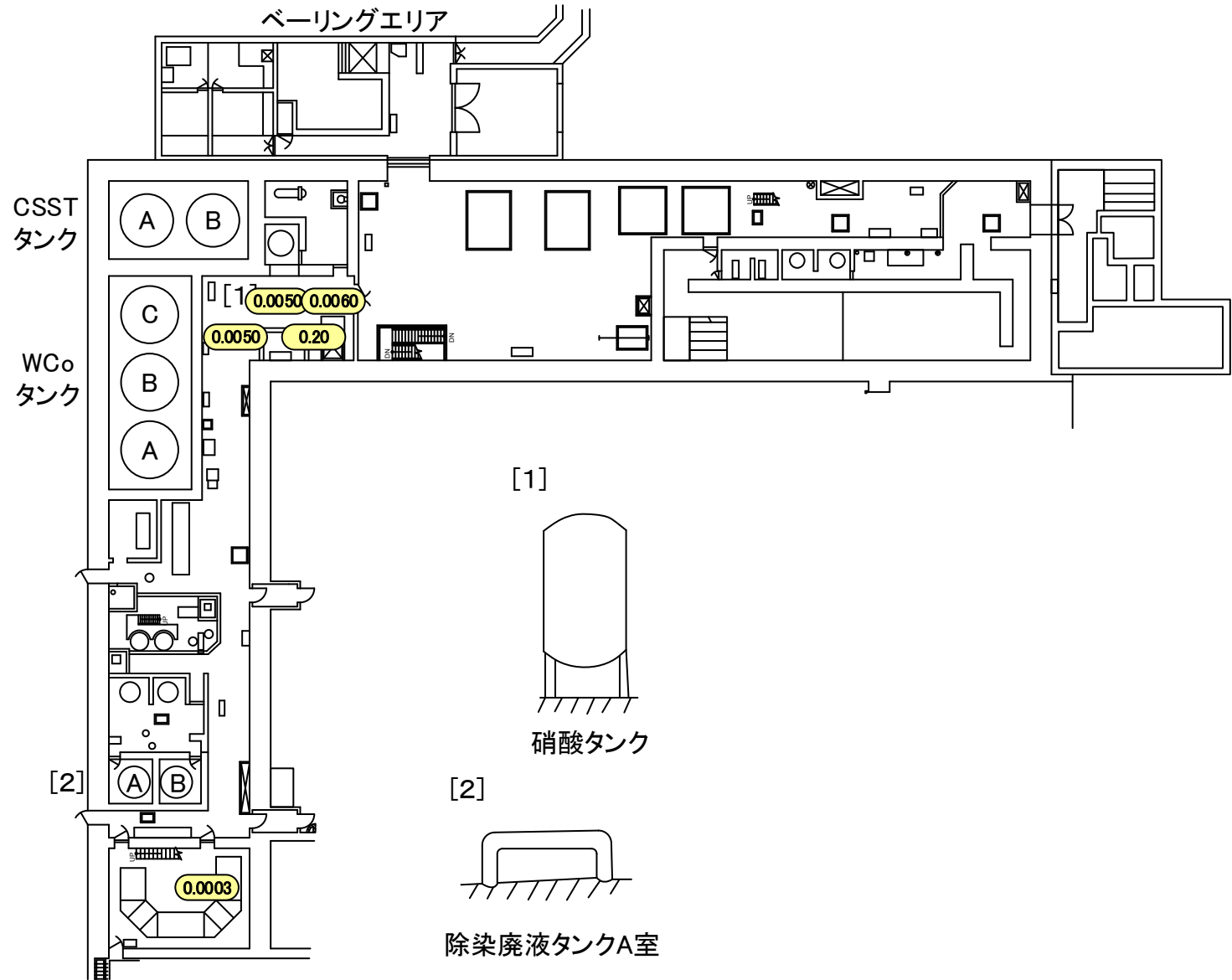

福島第一 原子力発電所

図面名称:

6号機 廃棄物処理建屋 中2階

[単位: mSv/h]

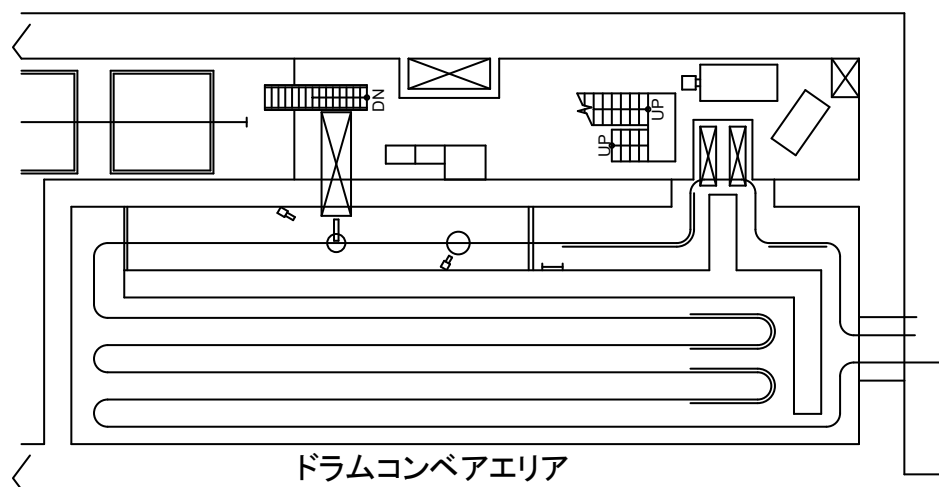

福島第一 原子力発電所	図面名称: 6号機 廃棄物処理建屋 2階	〔 単位: mSv/h 〕
-------------	----------------------	---------------

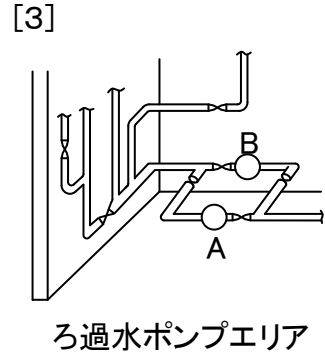
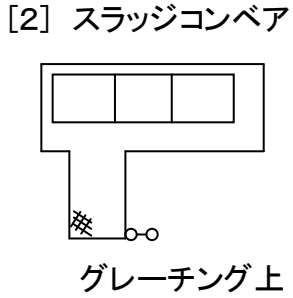
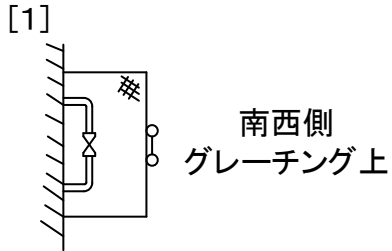
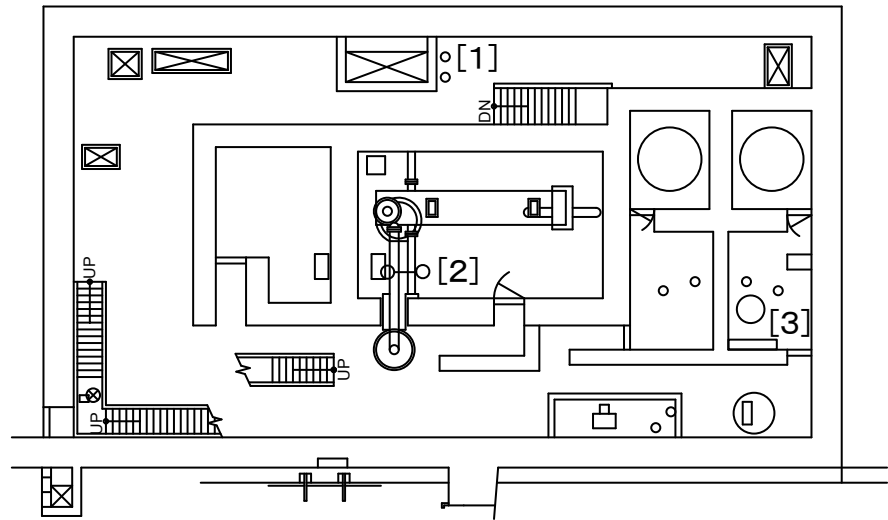

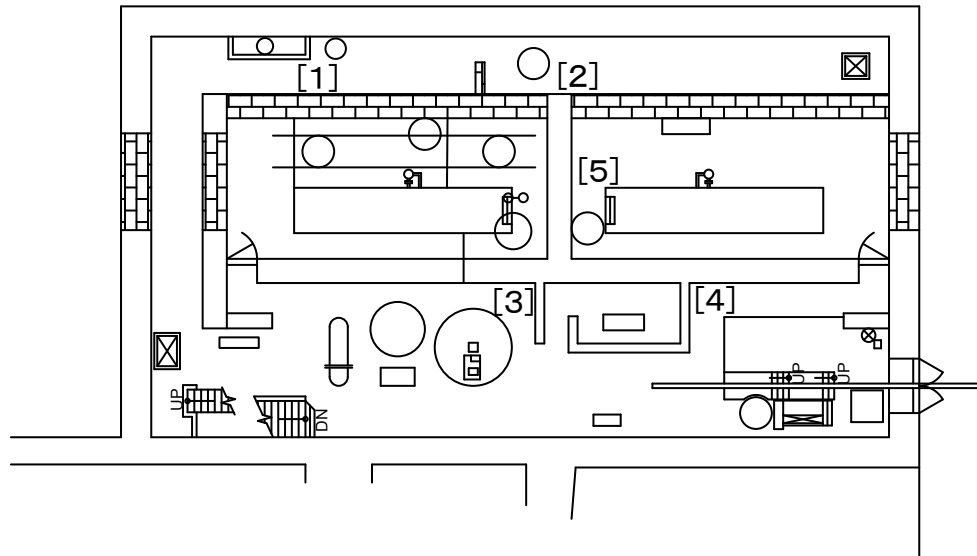

<D/G室>

非常用
D/G室

HPCS
D/G室

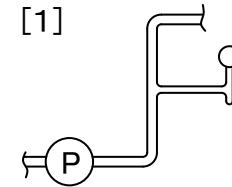

機器ドレン補助ろ過器ポンプ

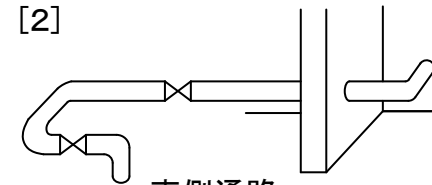

東側通路

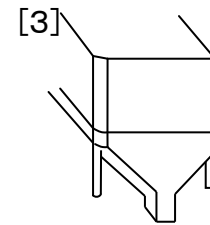

機器ドレンTBF

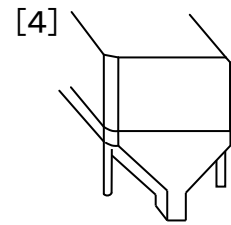

床ドレンTBF

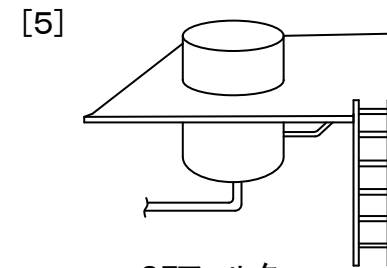

SFフィルター