

2016年1月29日  
東京電力株式会社

# 建屋内の空間線量率について

データ採取期間

- ・ 5号機 : 2015年11月1日～2015年11月30日

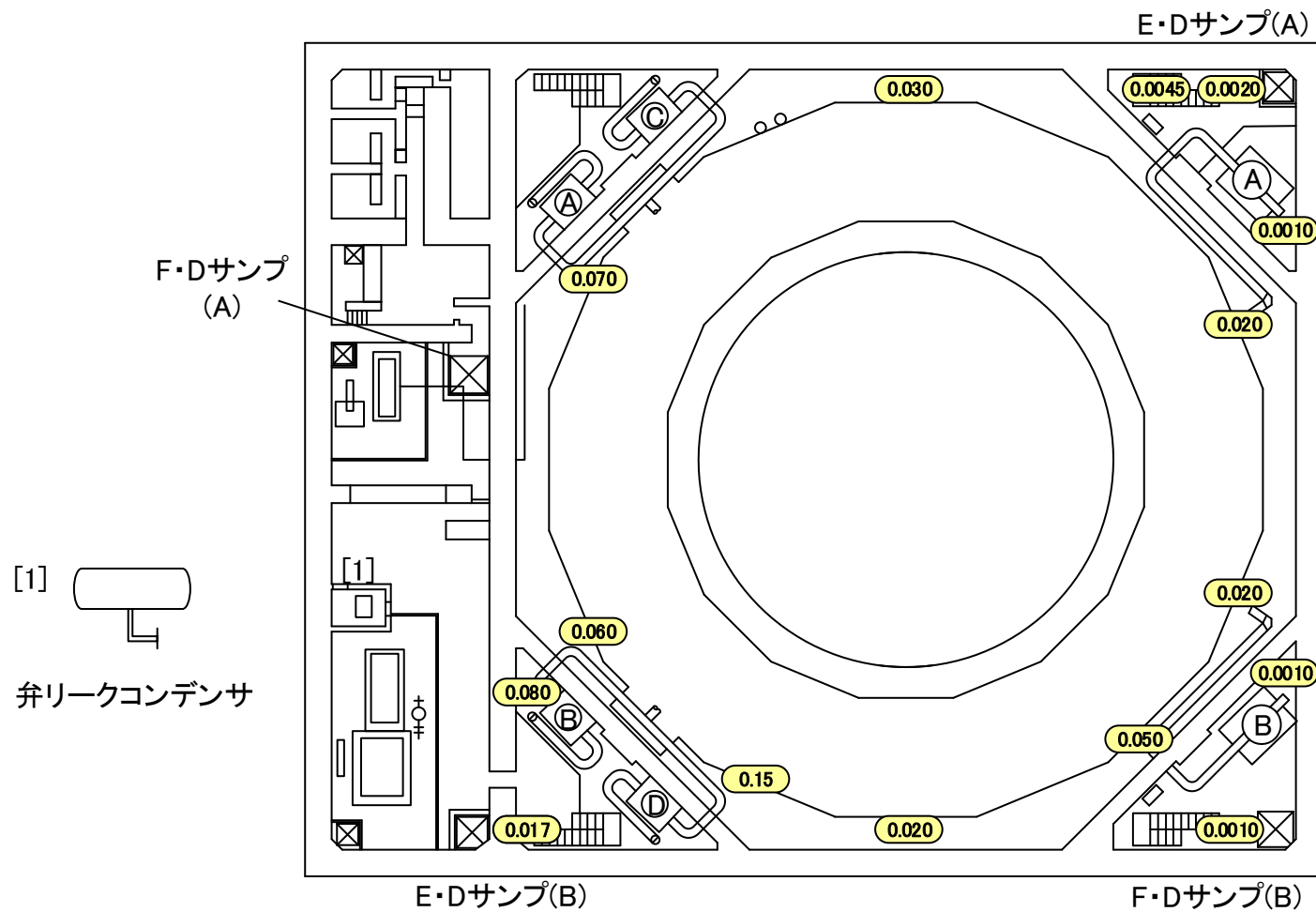

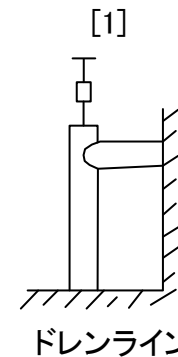
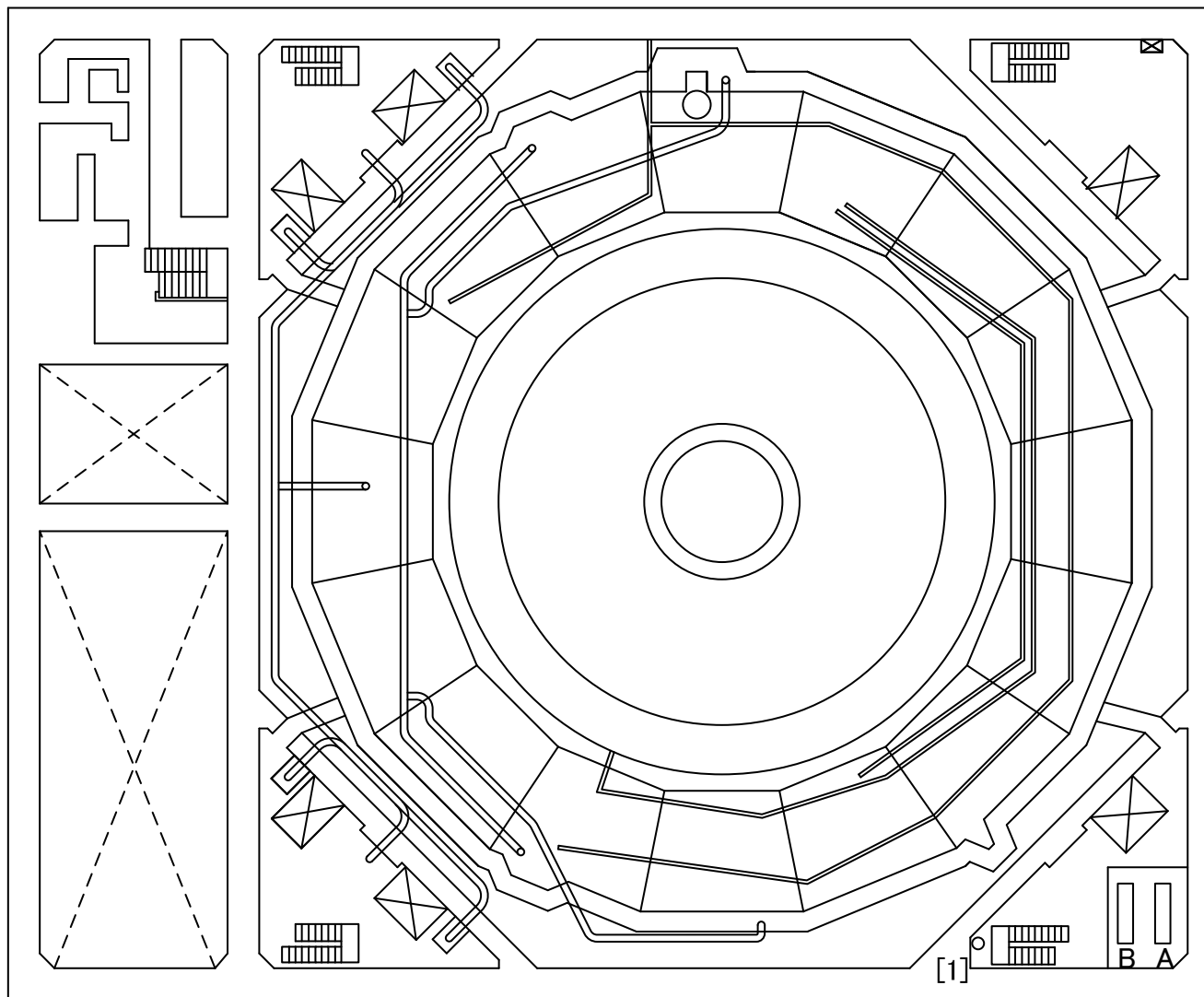

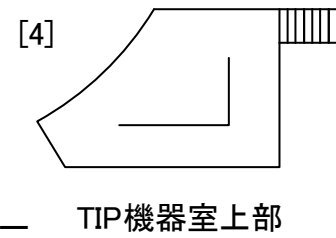
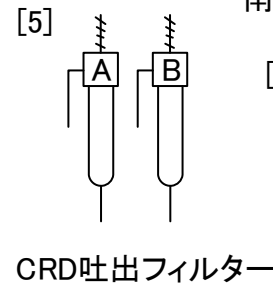
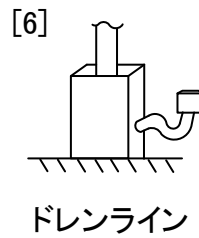
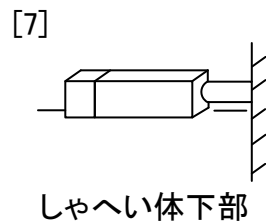
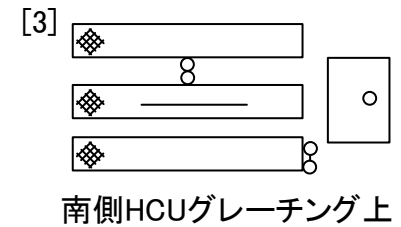
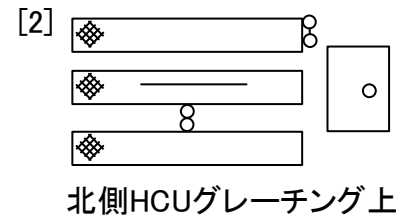
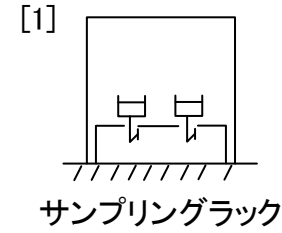
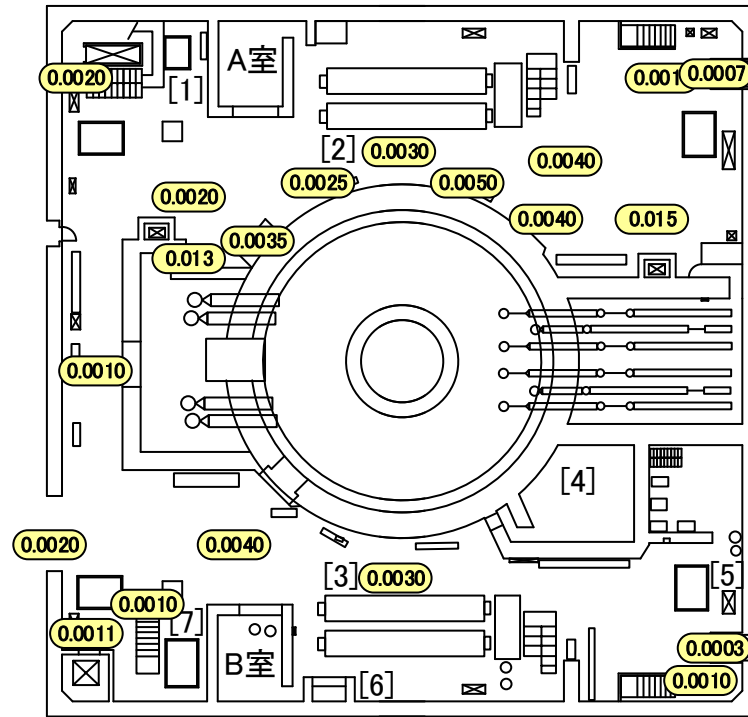

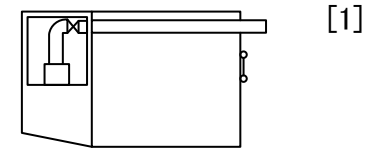
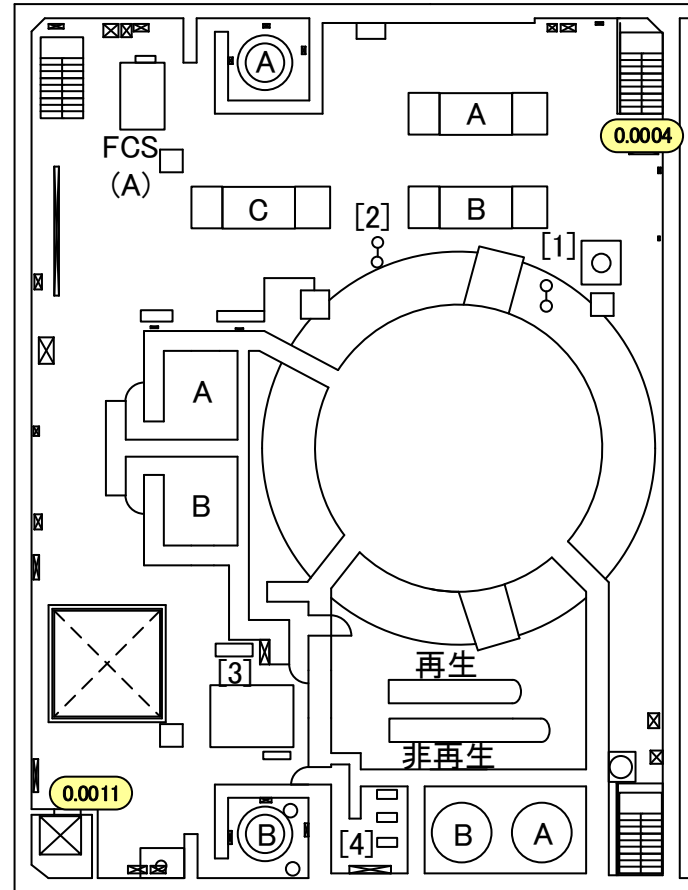

北東側グレーチング上

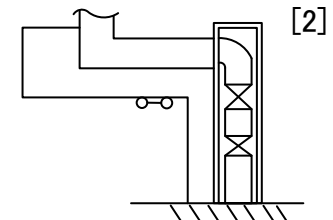

北側グレーチング上

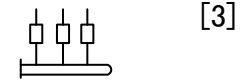

計装ラック下部

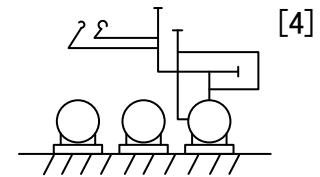

スラッジ放出混合ポンプ

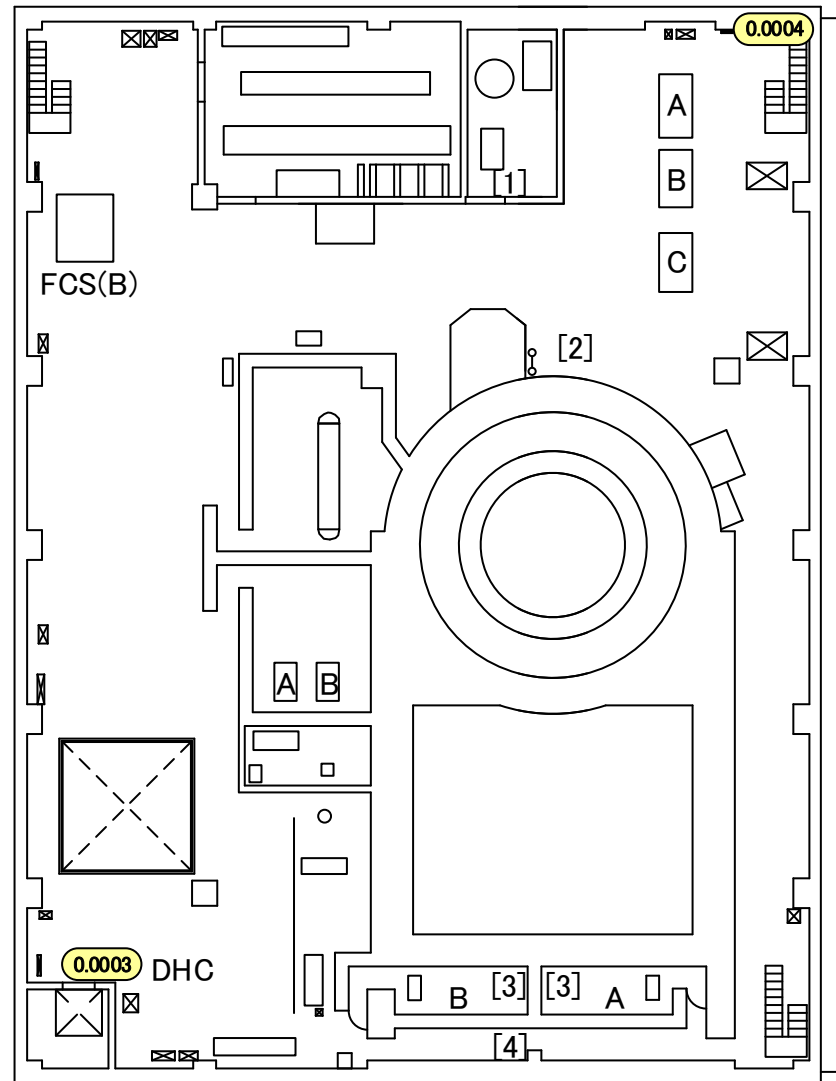
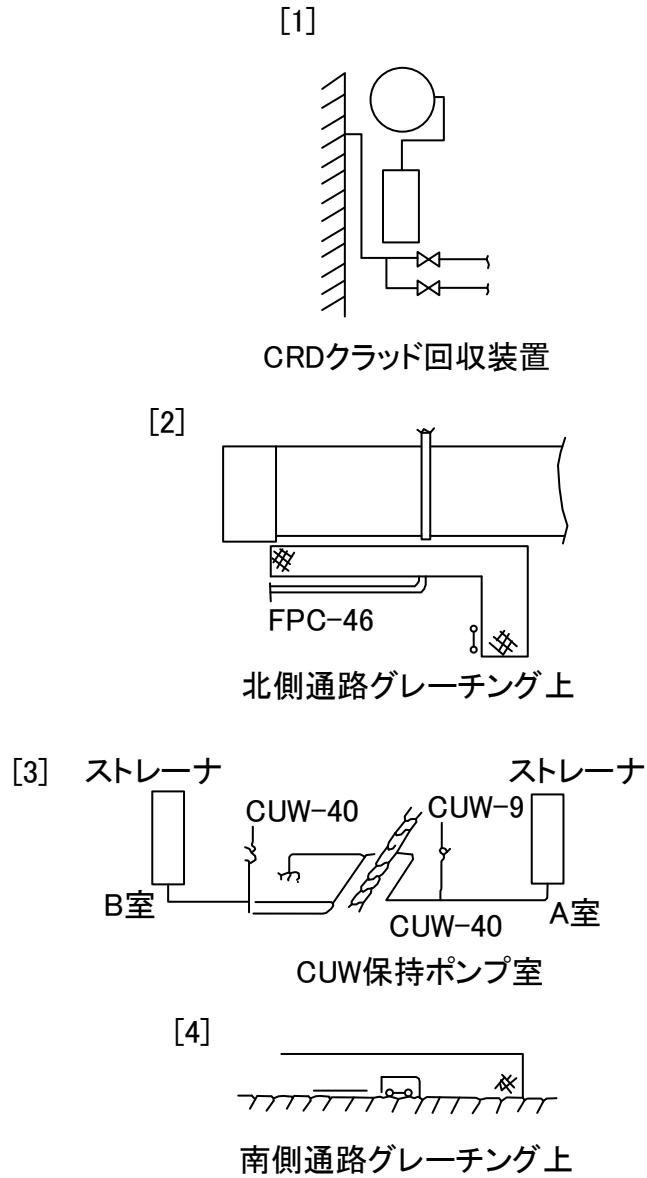

1F05RB004-00-01



0 10000

[1]

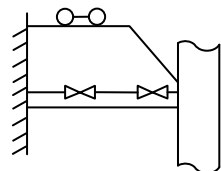

ウェル換気(東側)

[2]

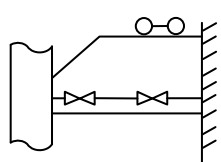

ウェル換気(西側)

[3]

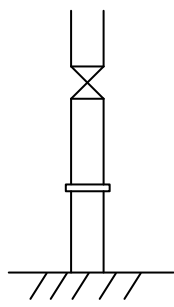

FPC-46

[4]

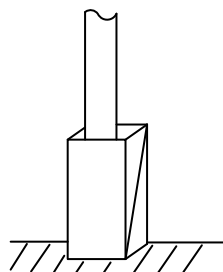

FPC-8

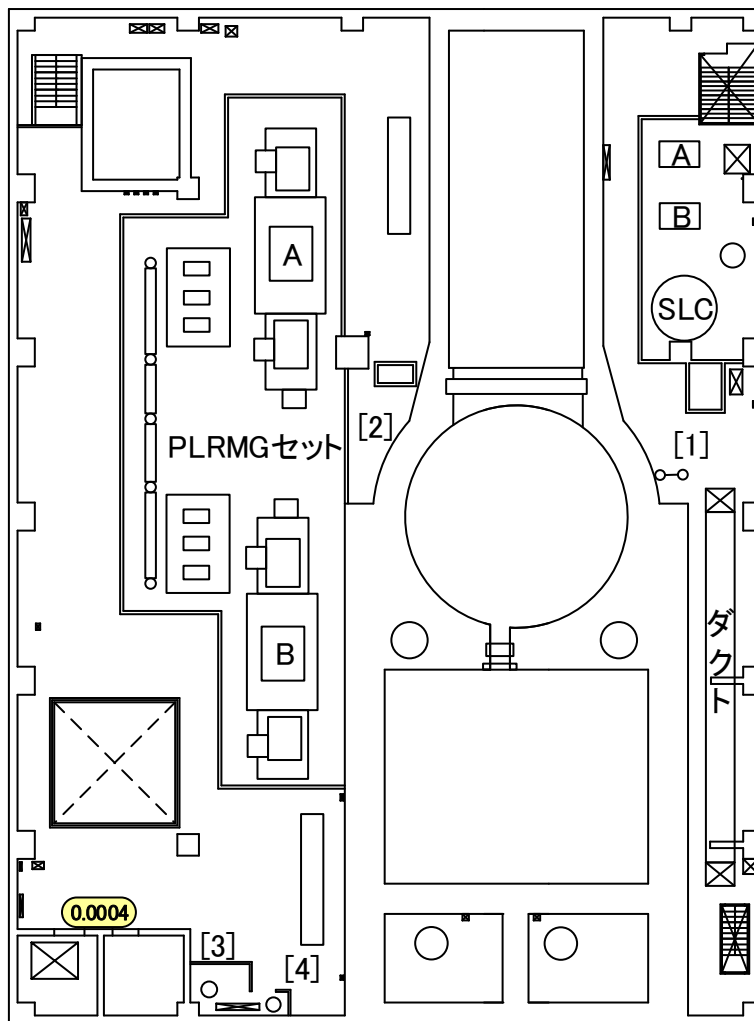

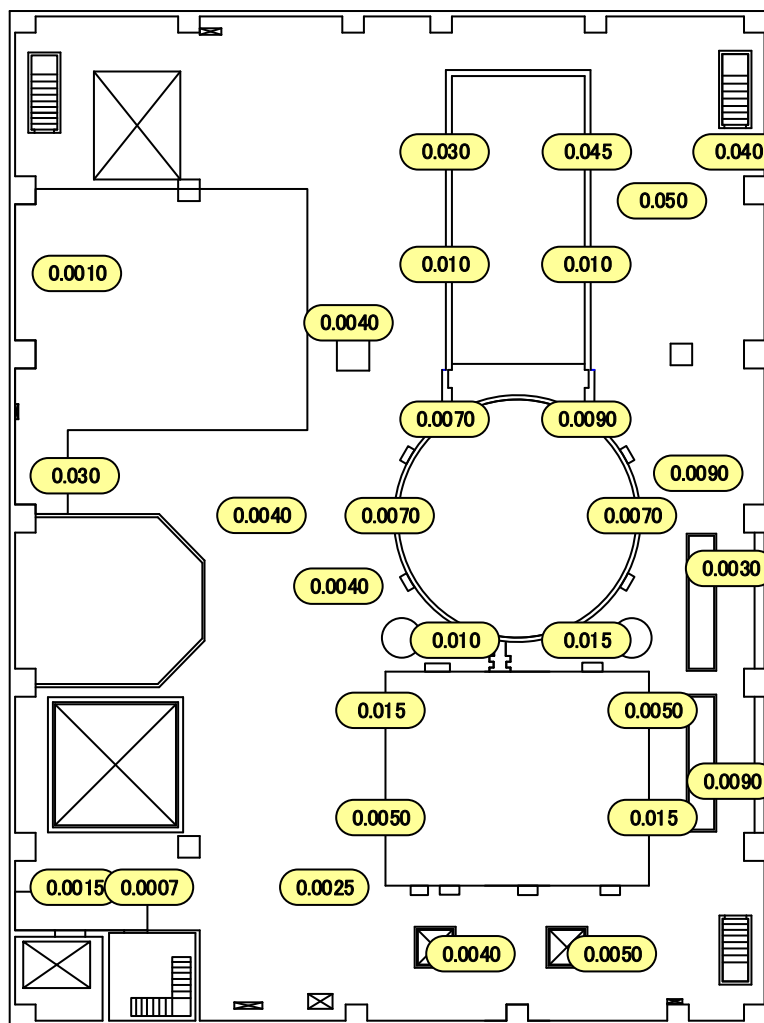



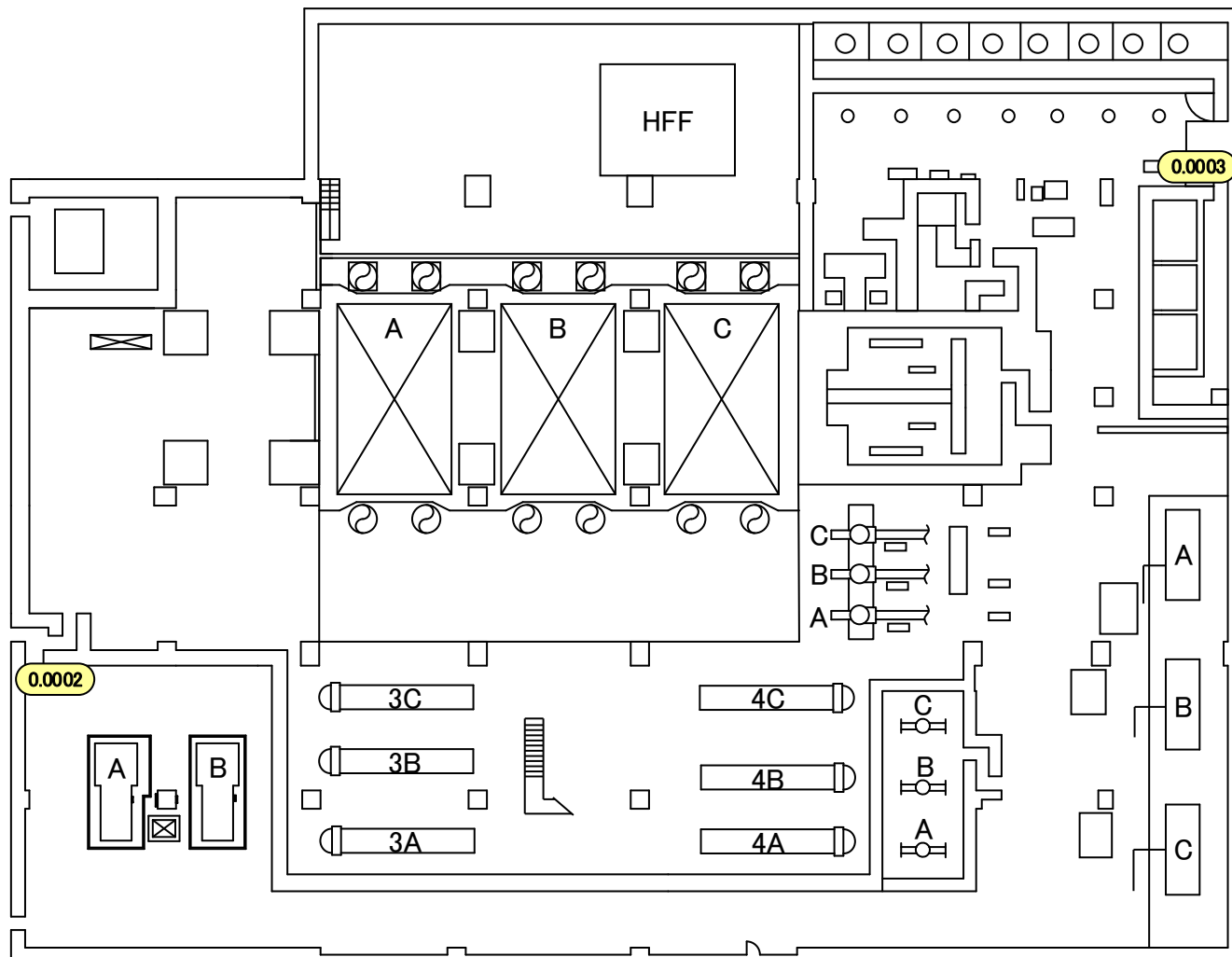

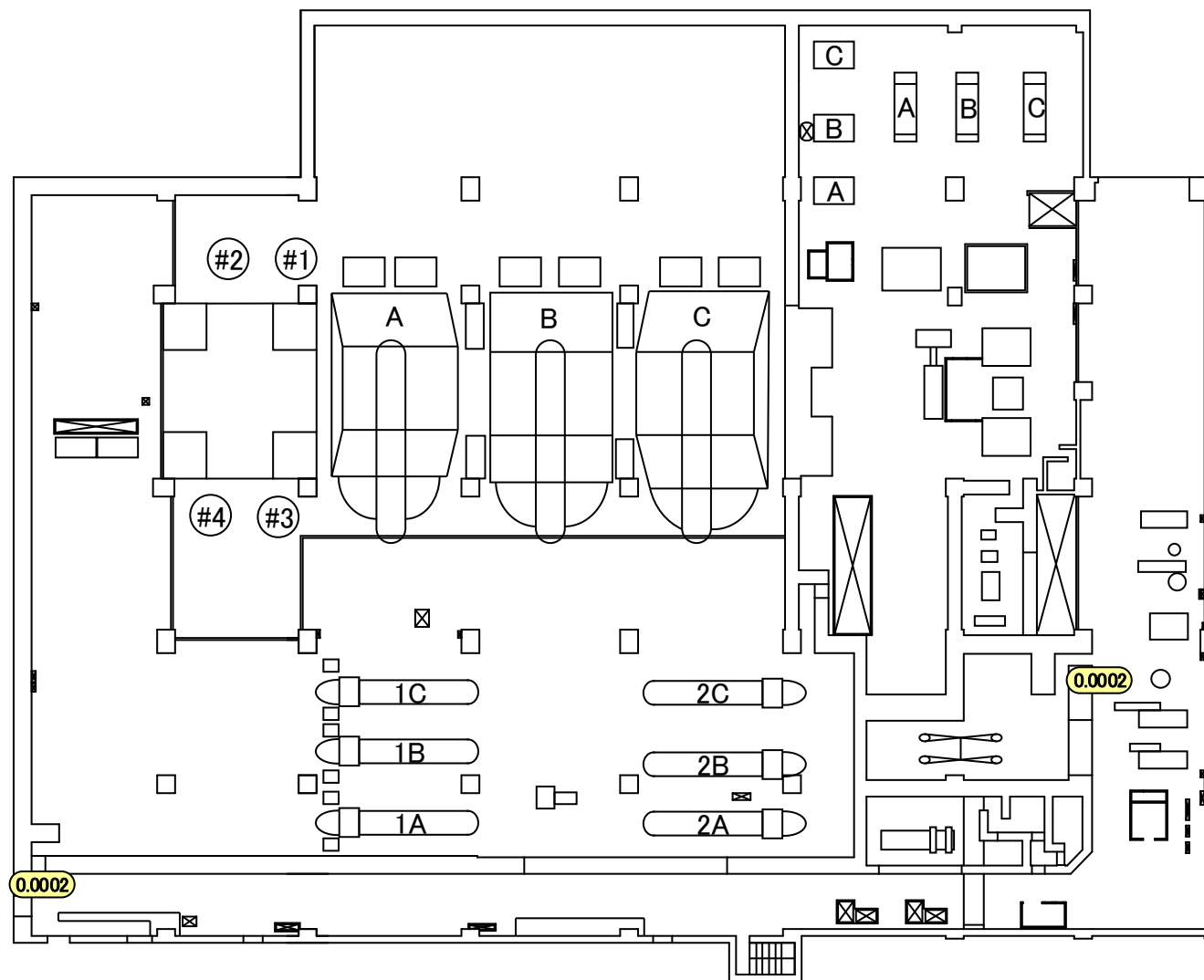

[1]  
AS-23

[2]  
エバポレータ

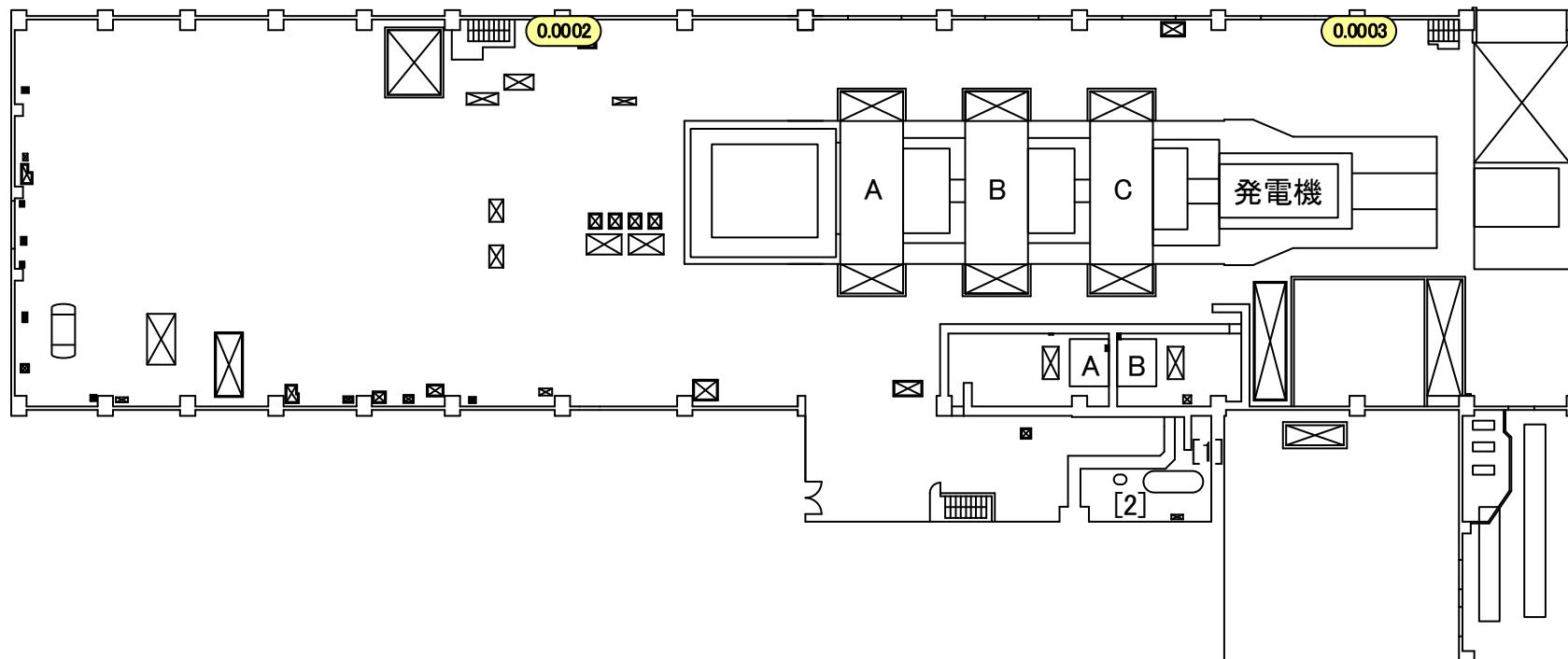
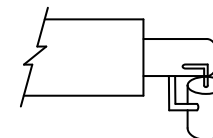
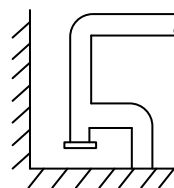

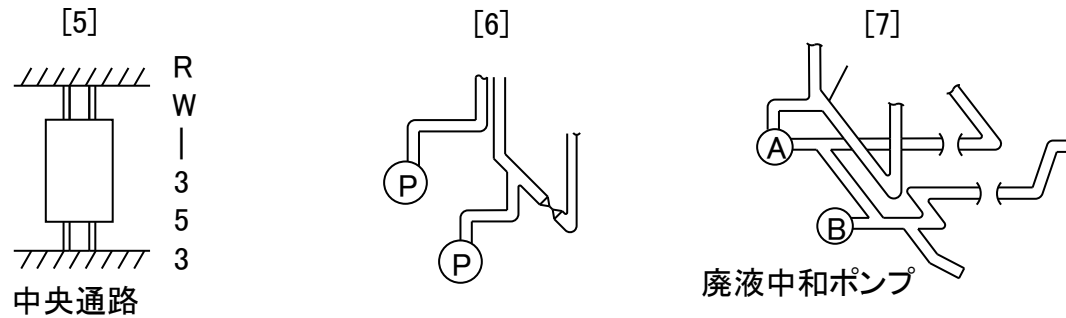
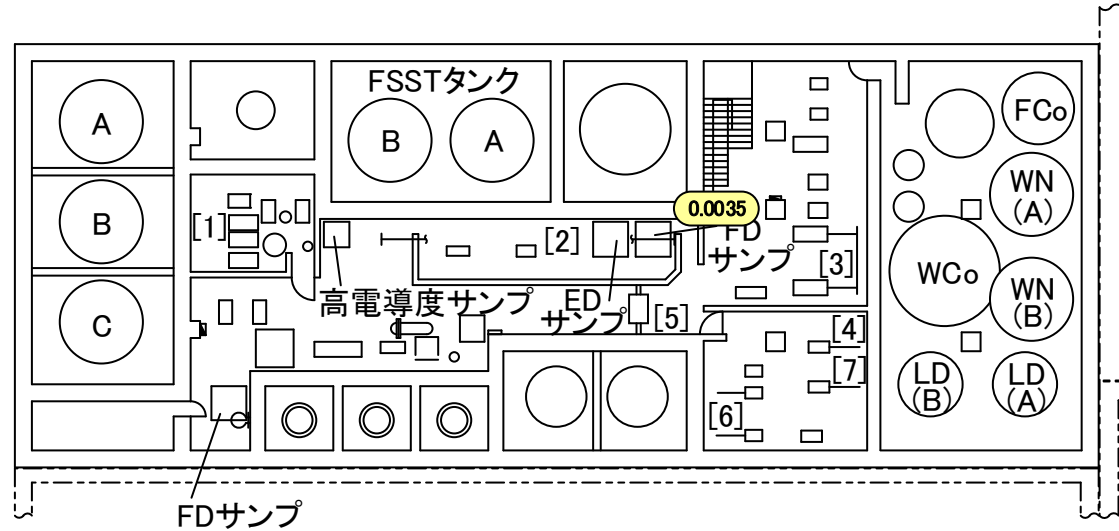
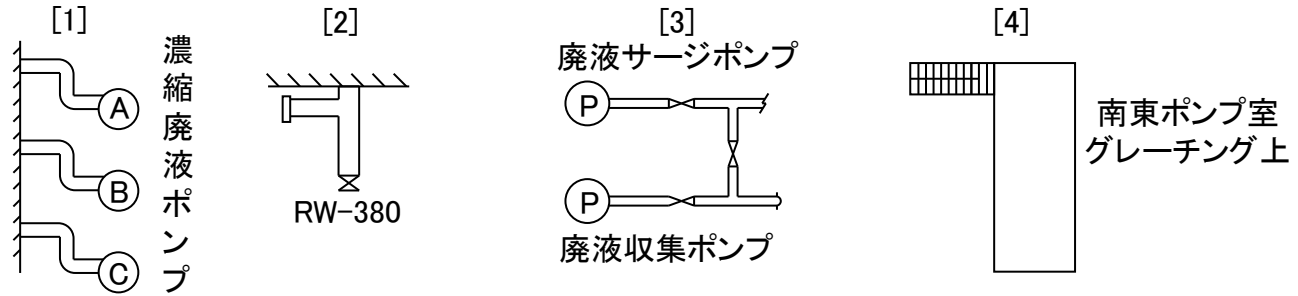

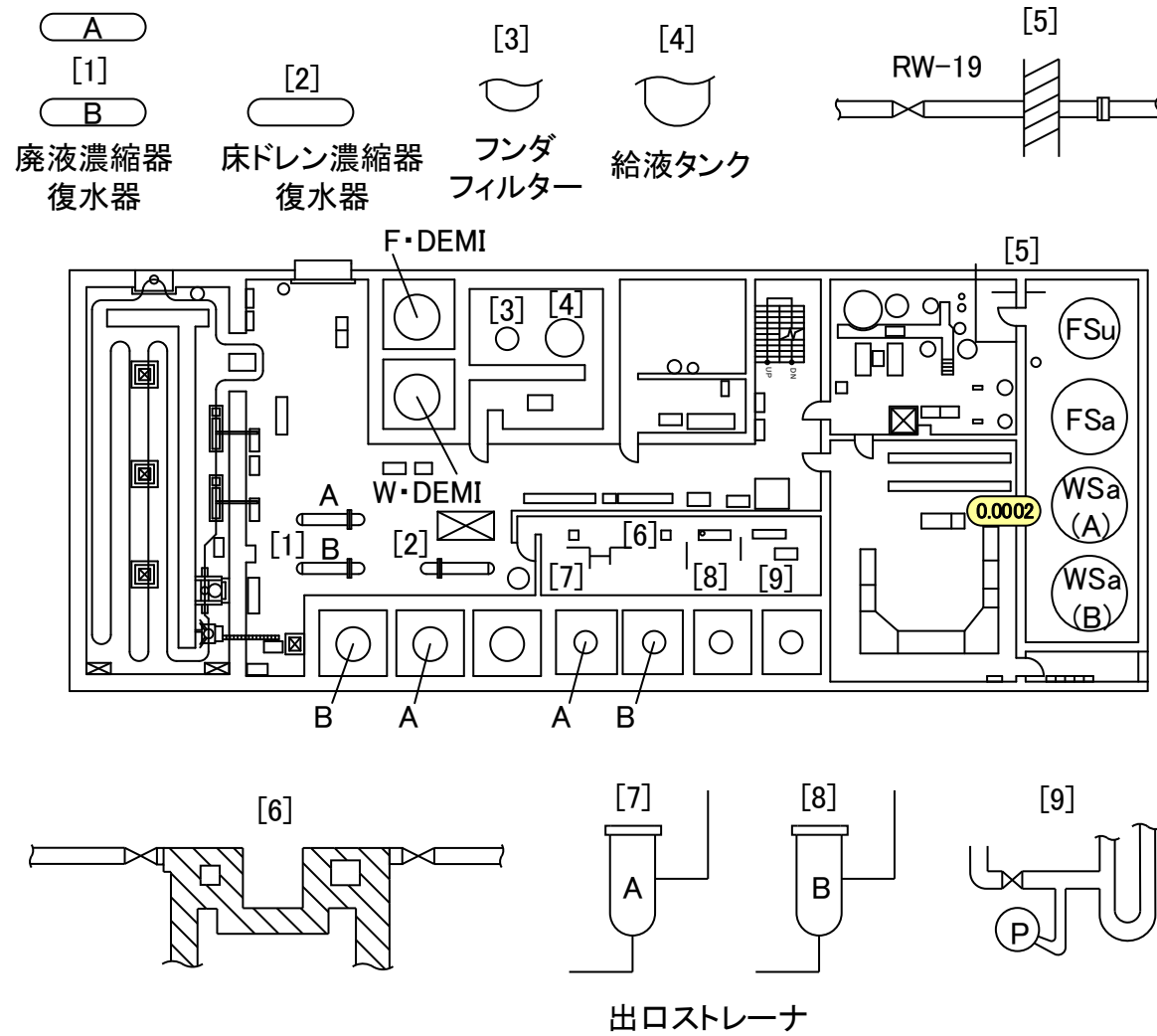

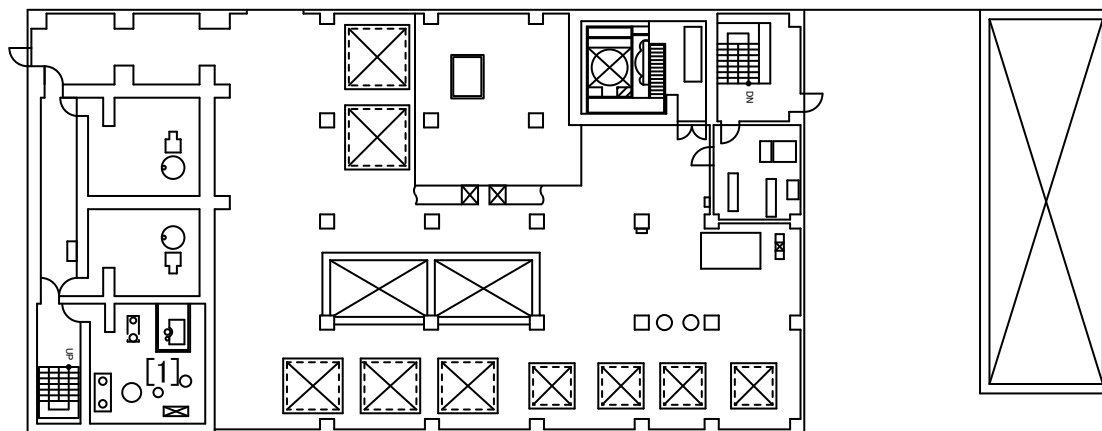

[1]



濃縮廃液計量タンク

