

2015年11月30日
東京電力株式会社

建屋内の空間線量率について

データ採取期間

・5号機:2015年4月1日～2015年9月30日

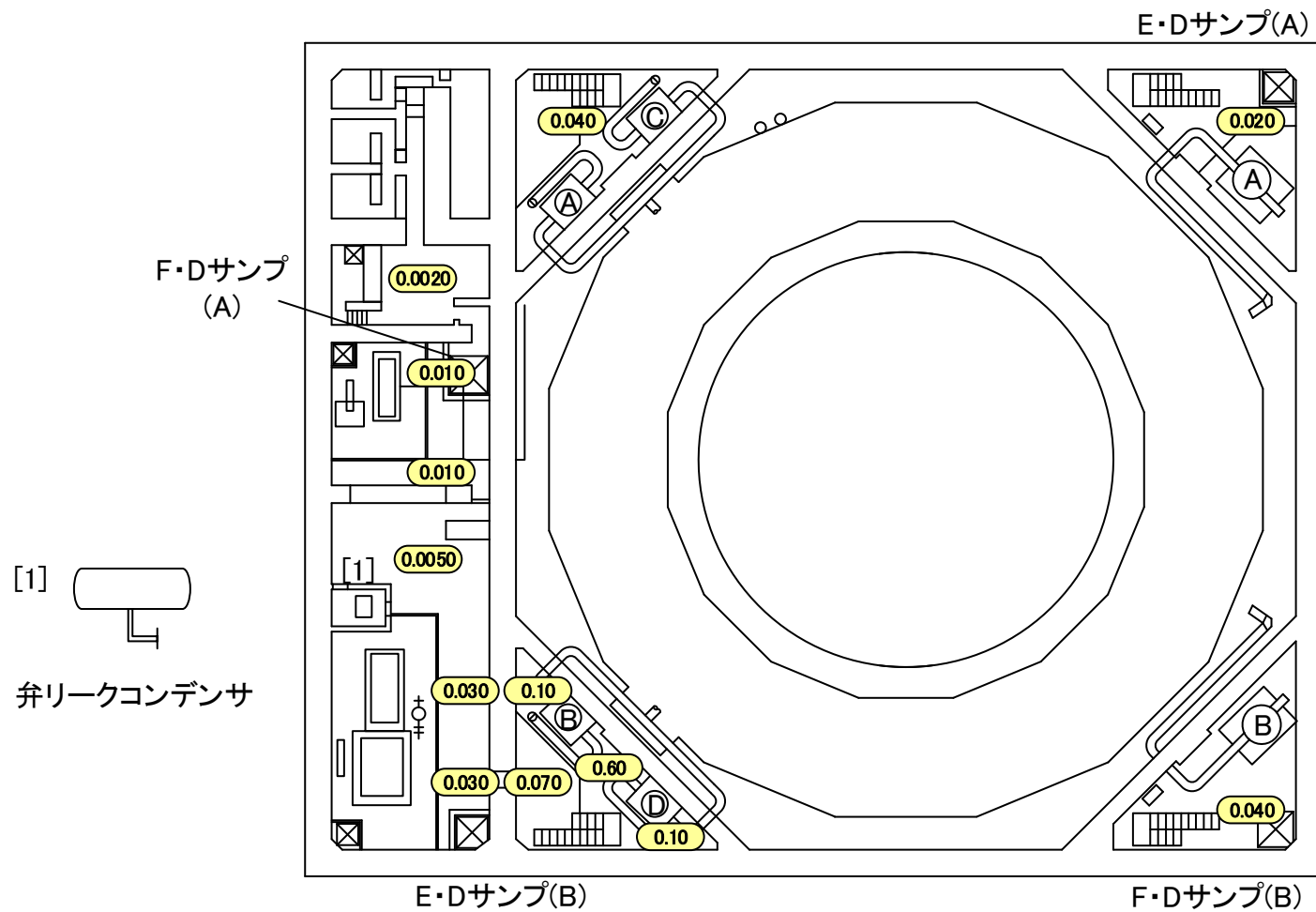

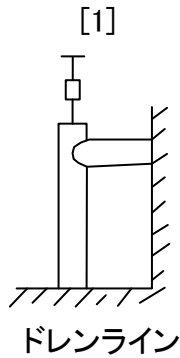
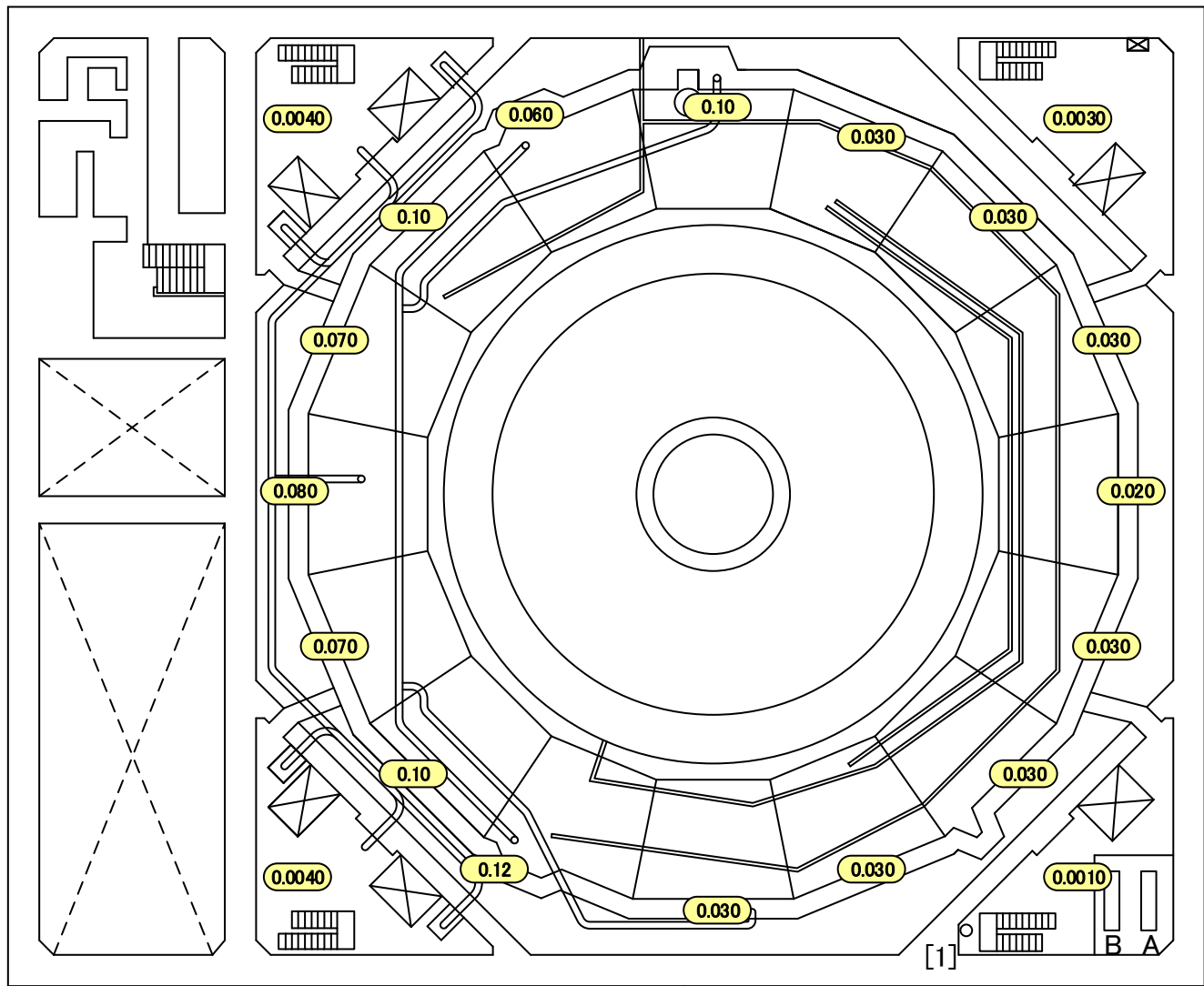

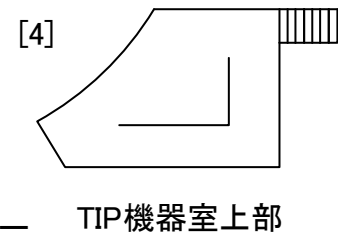
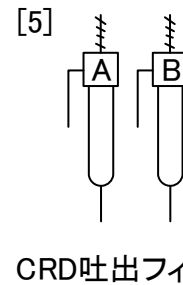
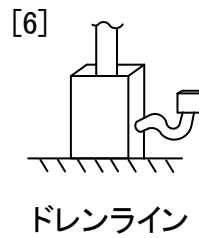
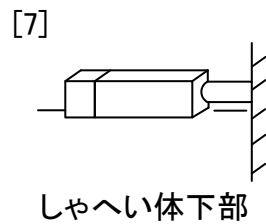
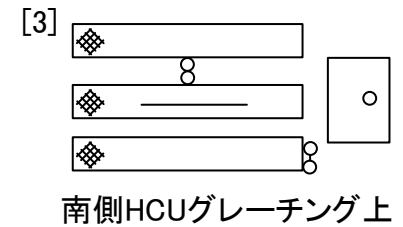
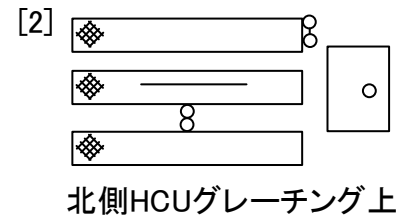
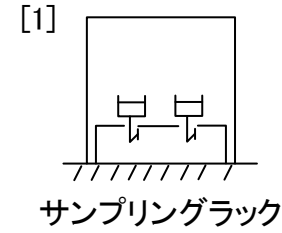
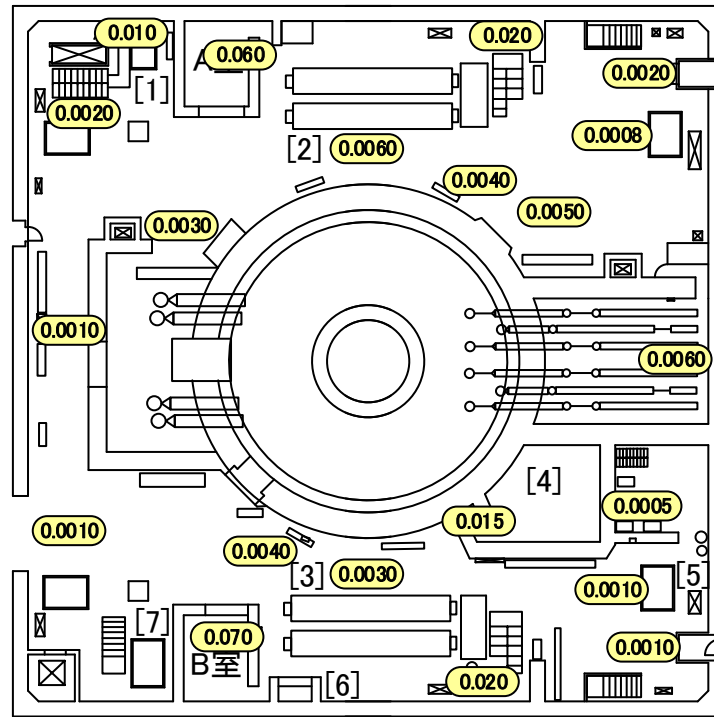

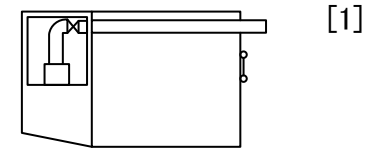
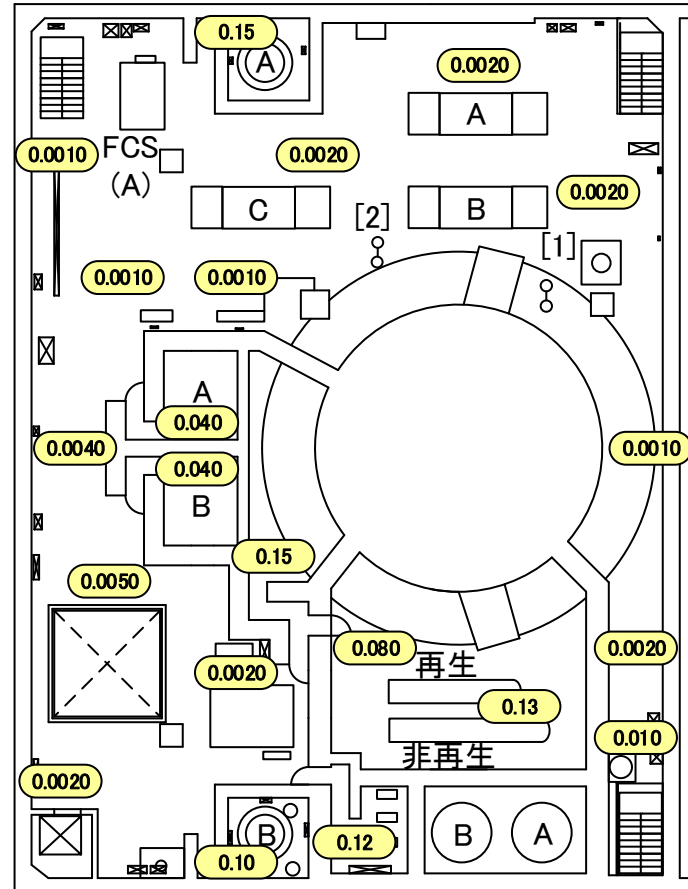

北東側グレーチング上

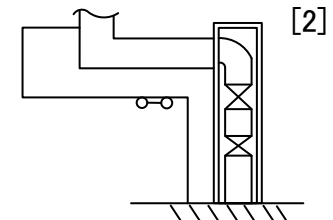

北側グレーチング上

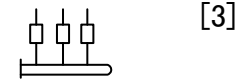

計装ラック下部

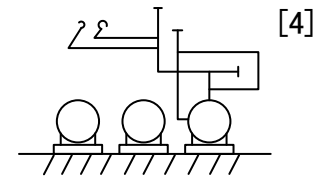

スラッジ放出混合ポンプ

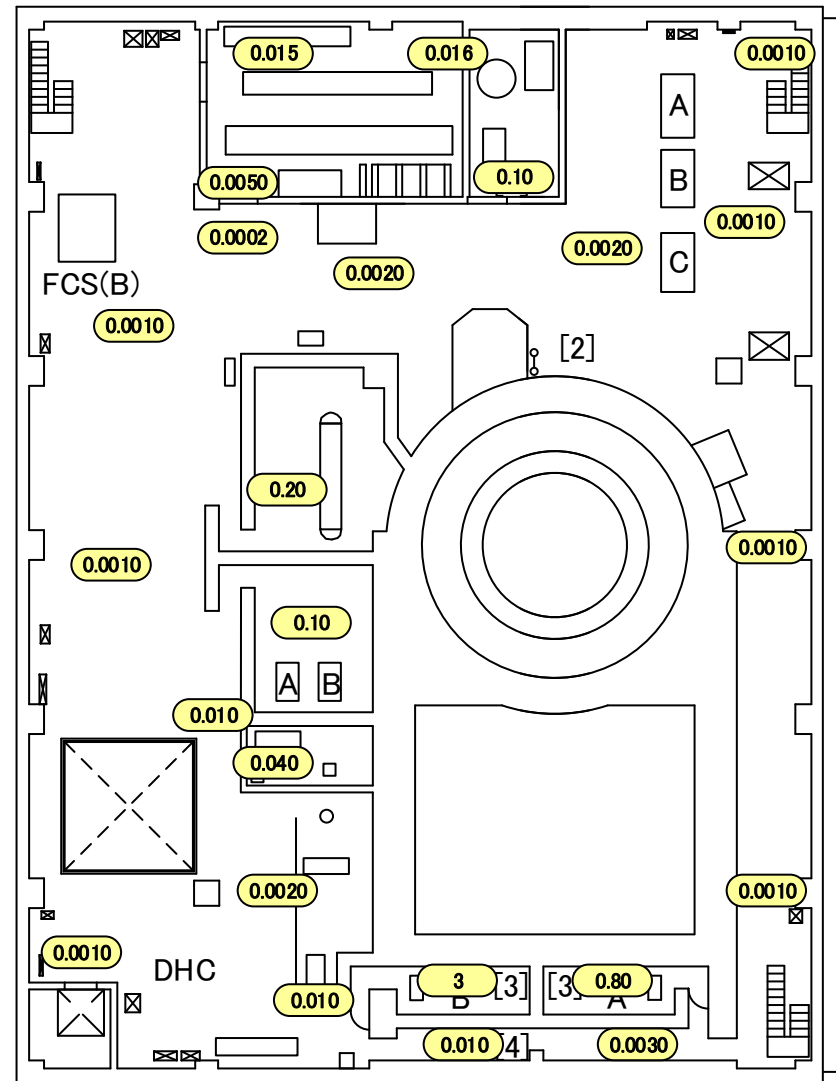
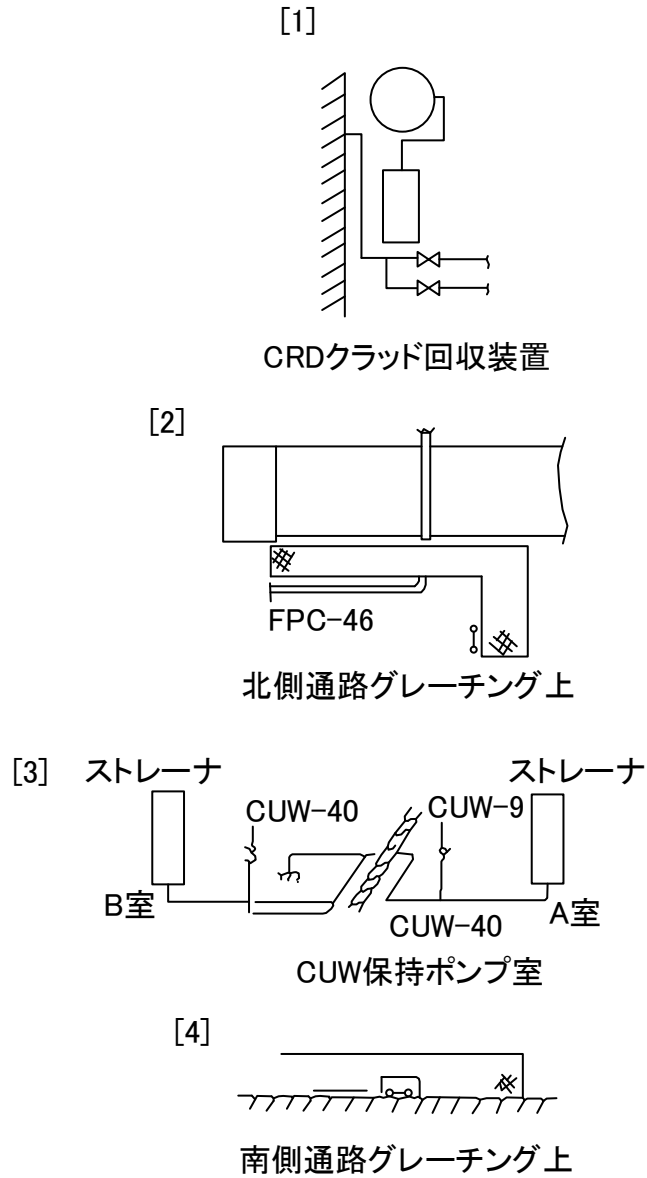

1F05RB004-00-01

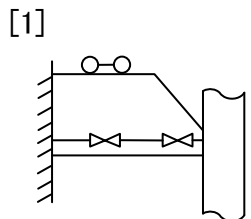

ウェル換気(東側)

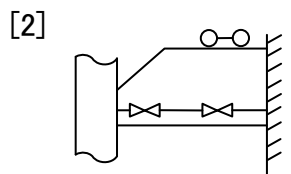

ウェル換気(西側)

[3]

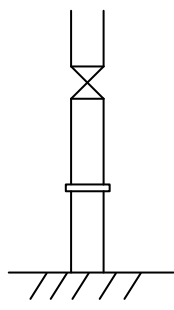

FPC-46

[4]

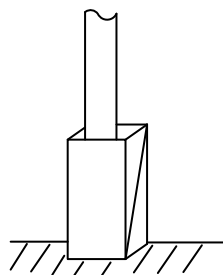

FPC-8

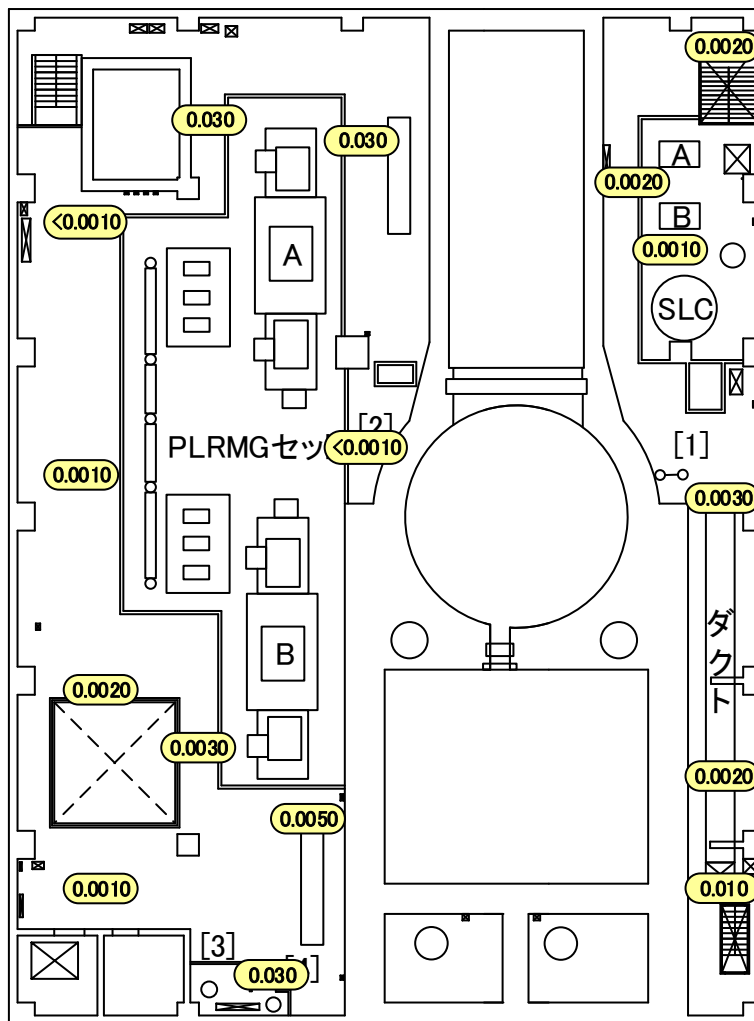

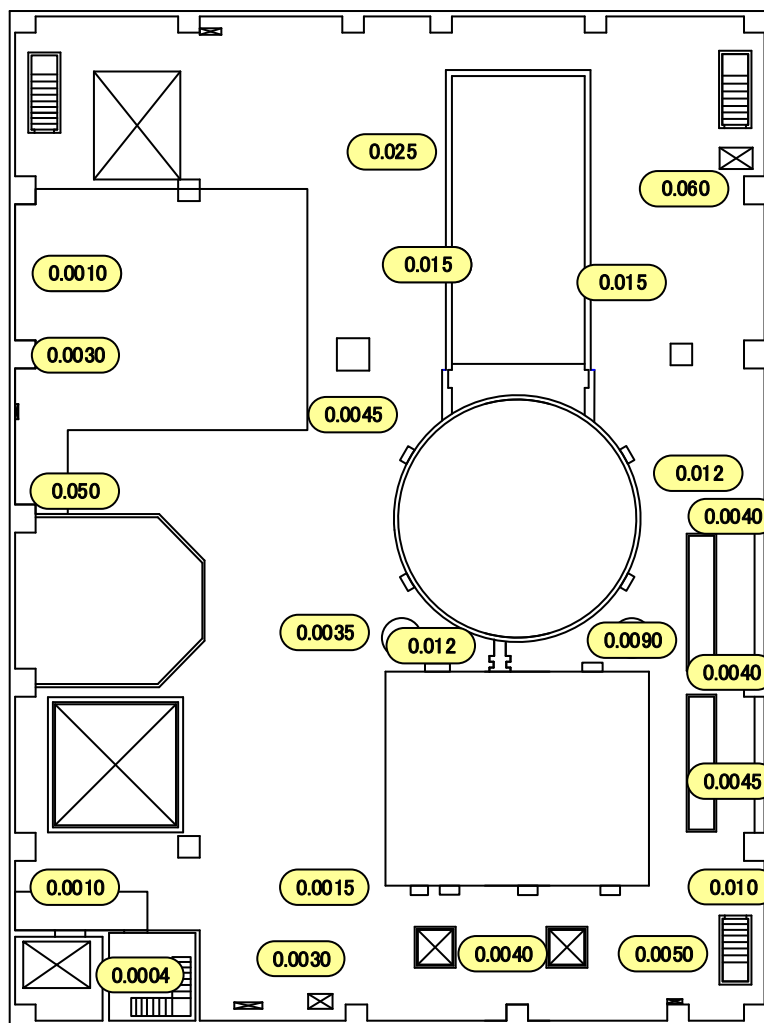

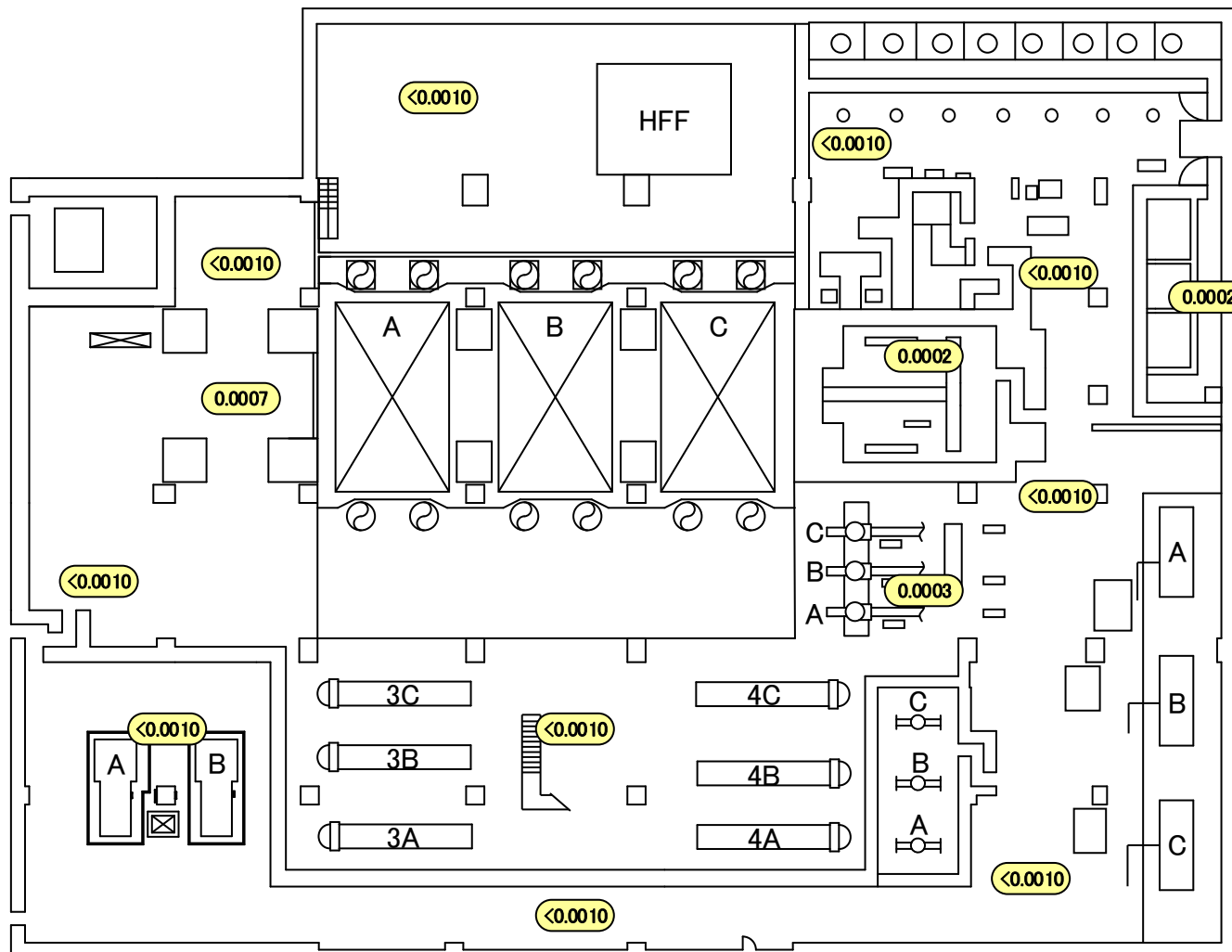

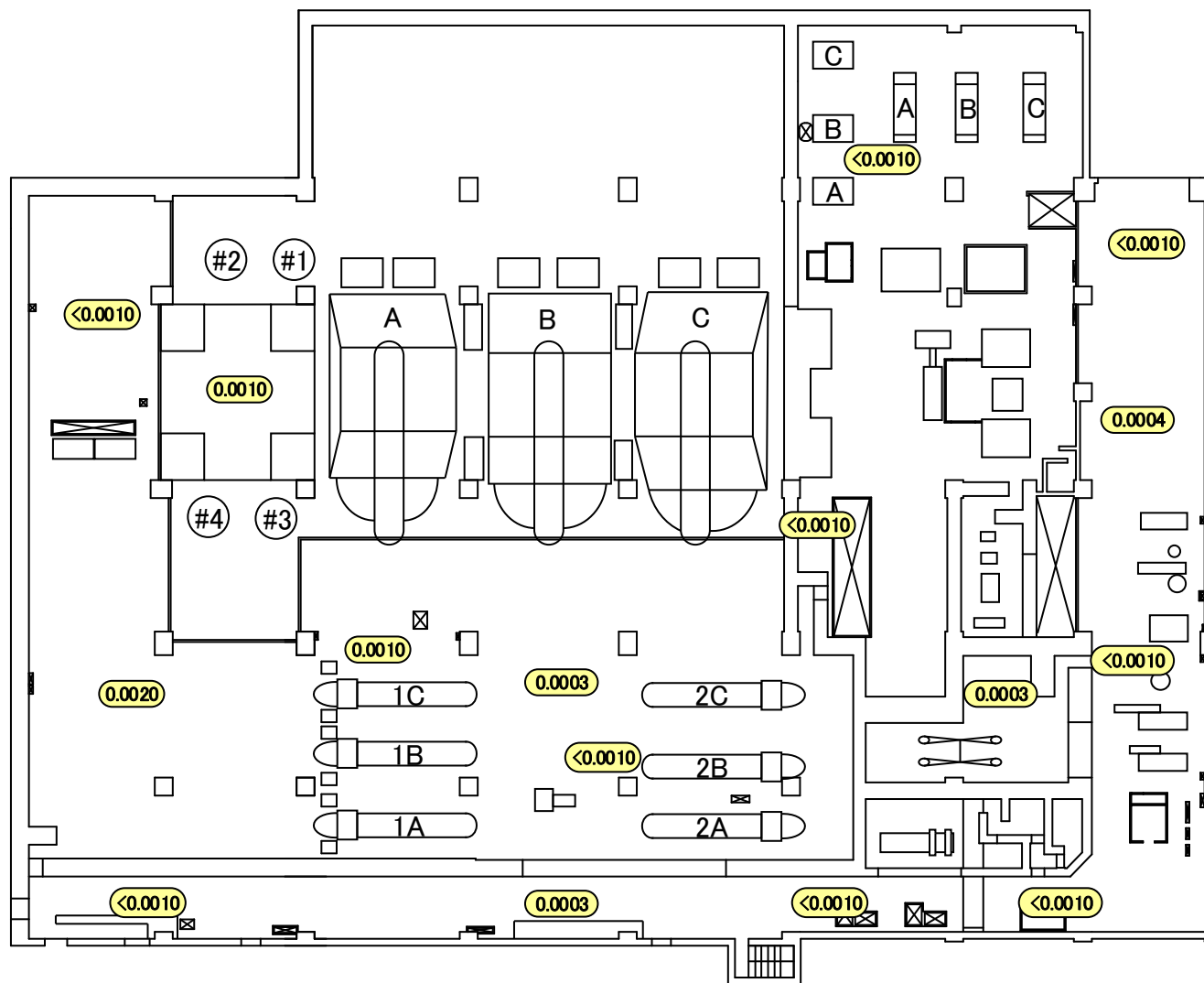

[1]
AS-23

[2]
エバポレータ

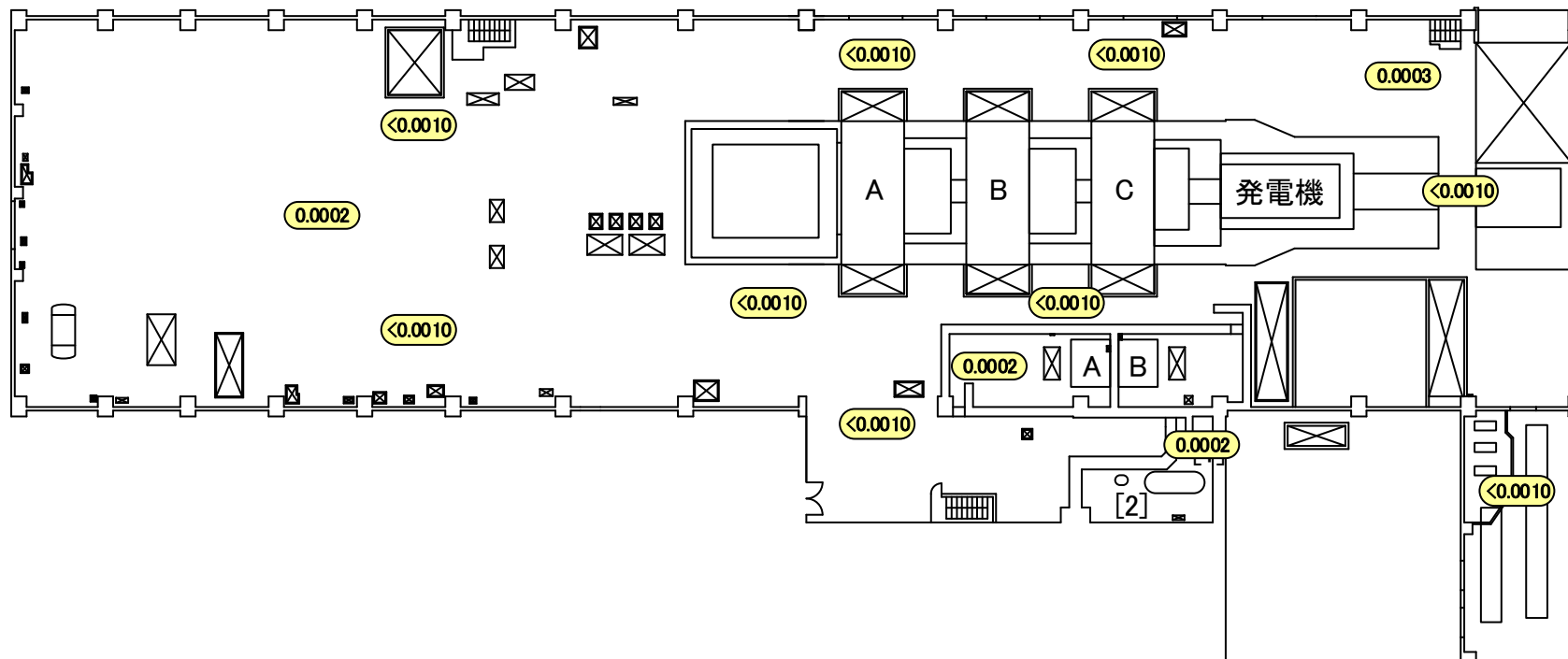
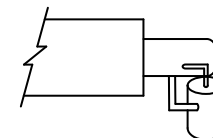
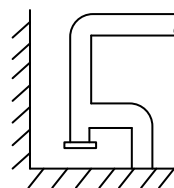

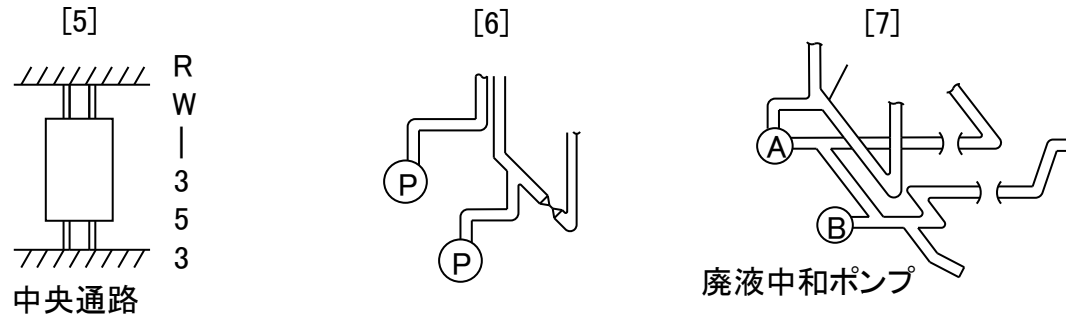
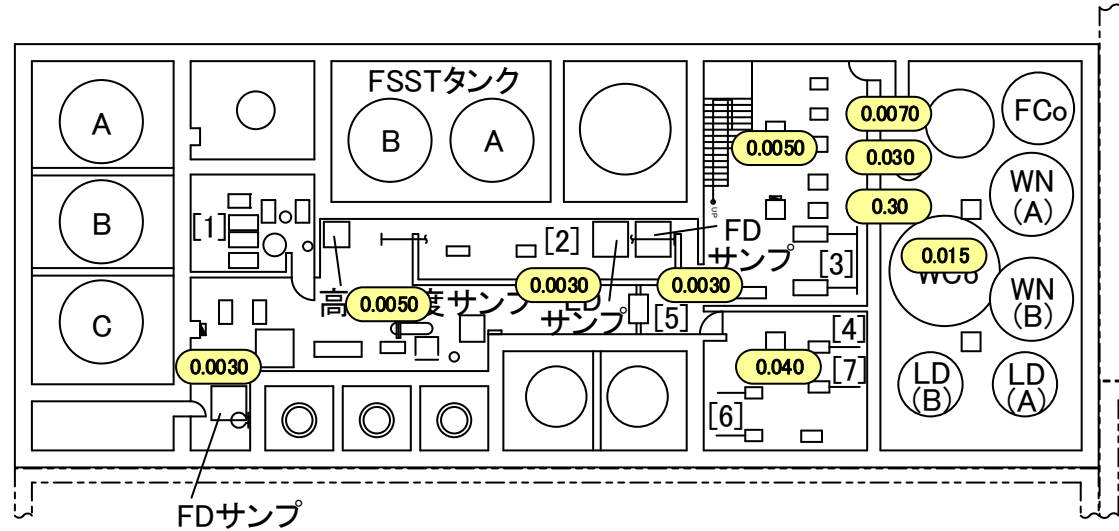
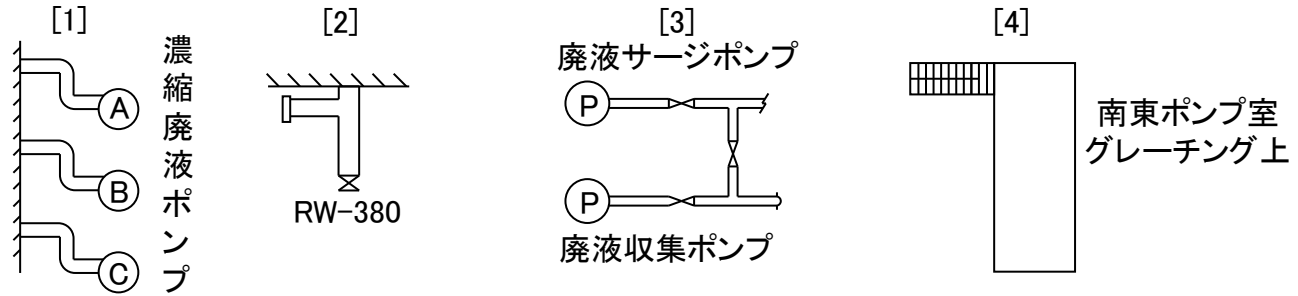

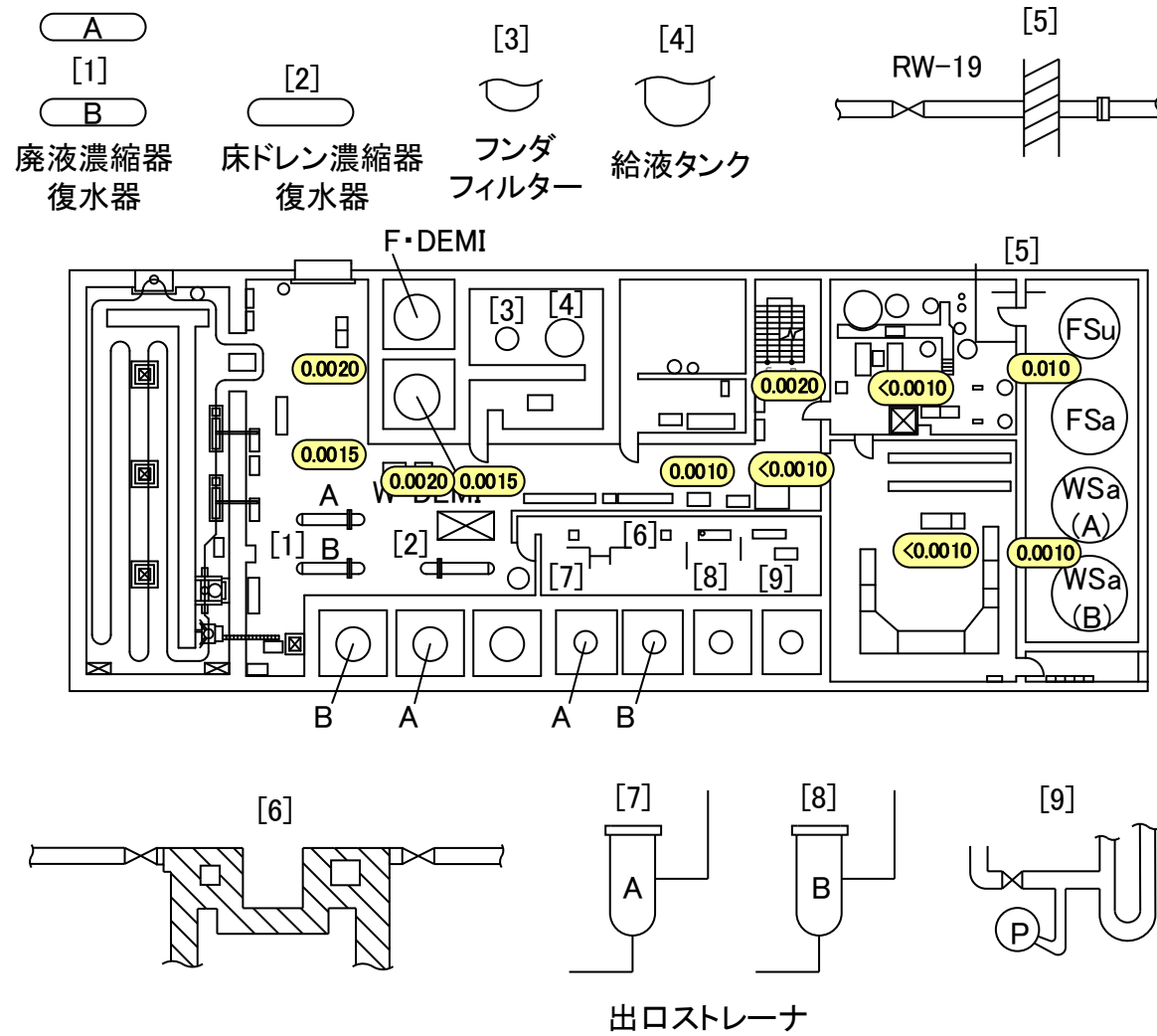

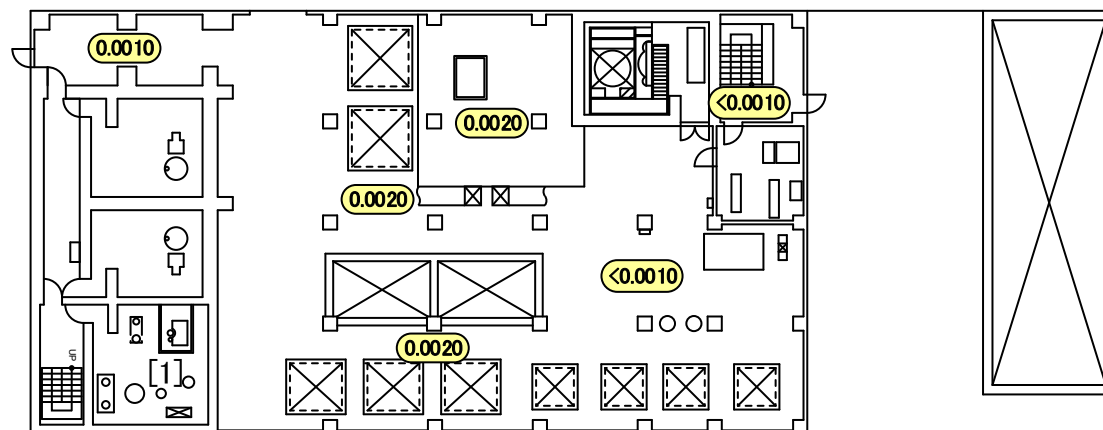

[1]



濃縮廃液計量タンク